

R40 Switch Left Ballasted PF Controlled

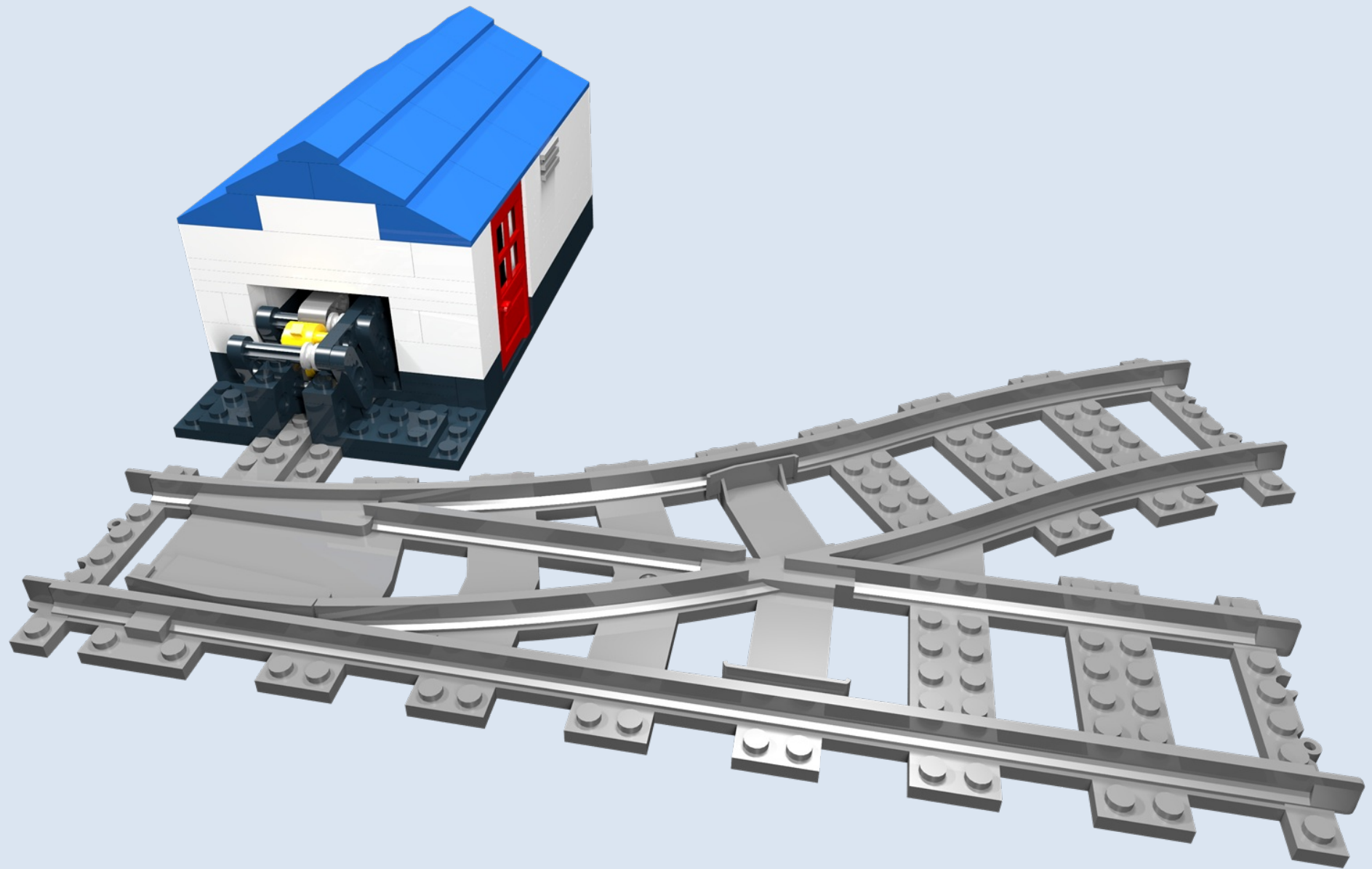

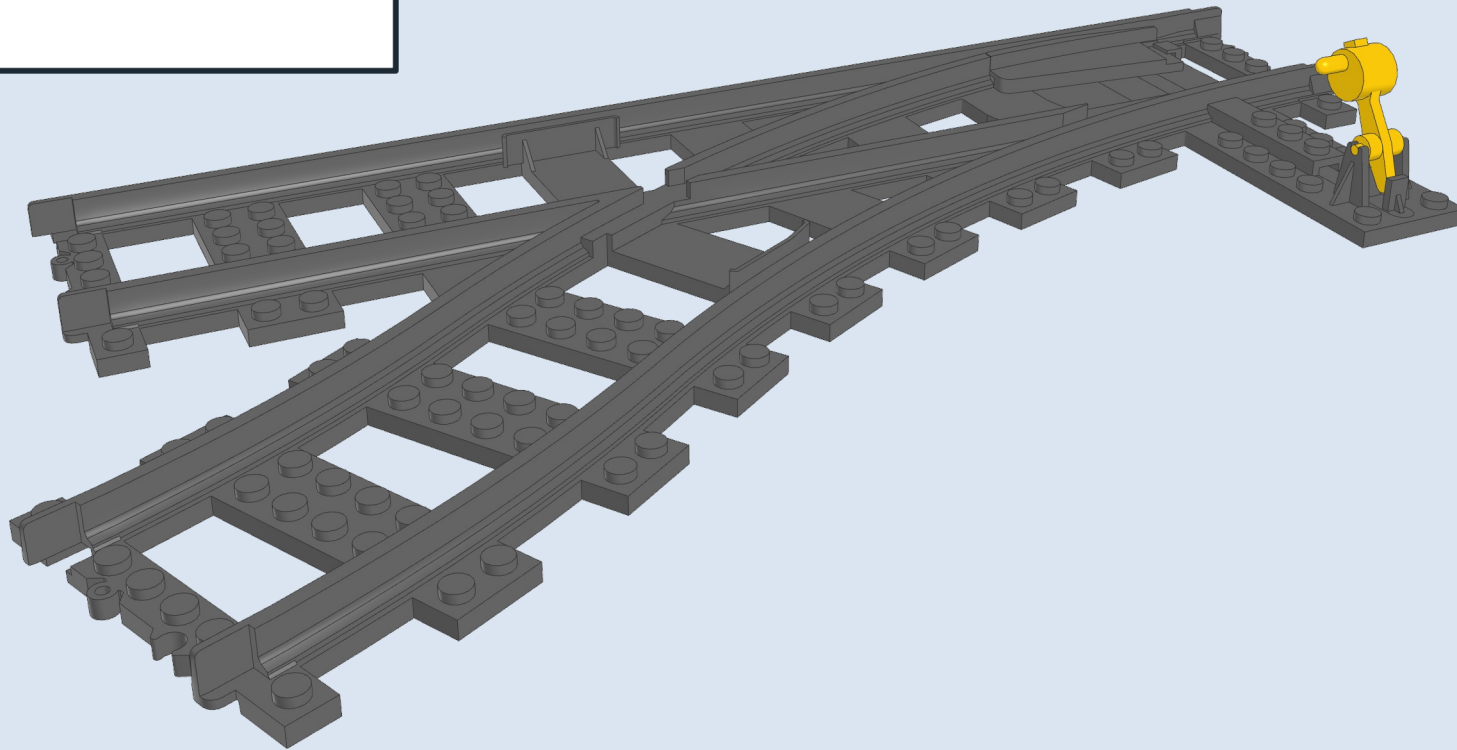

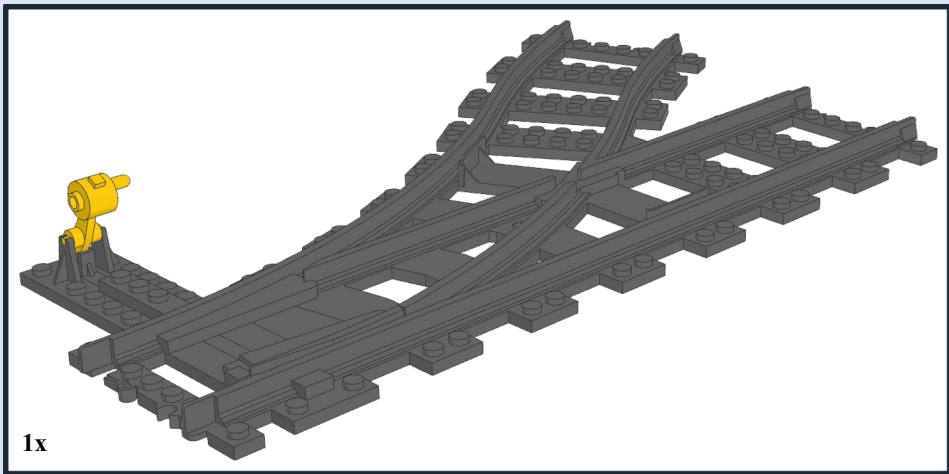

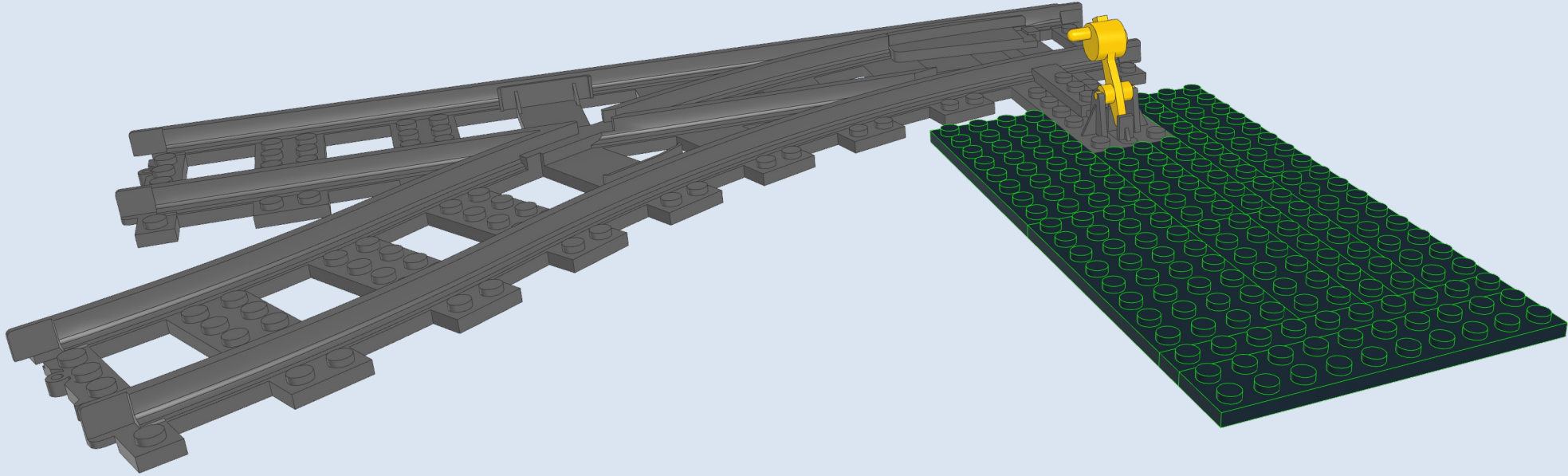
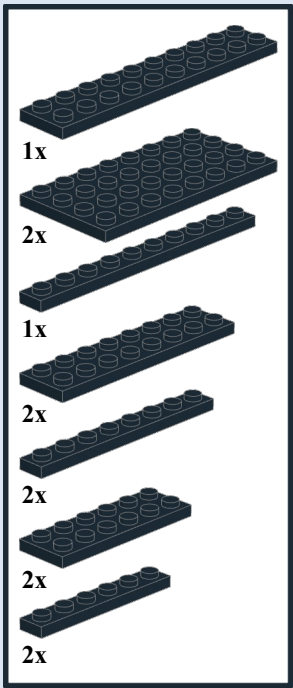
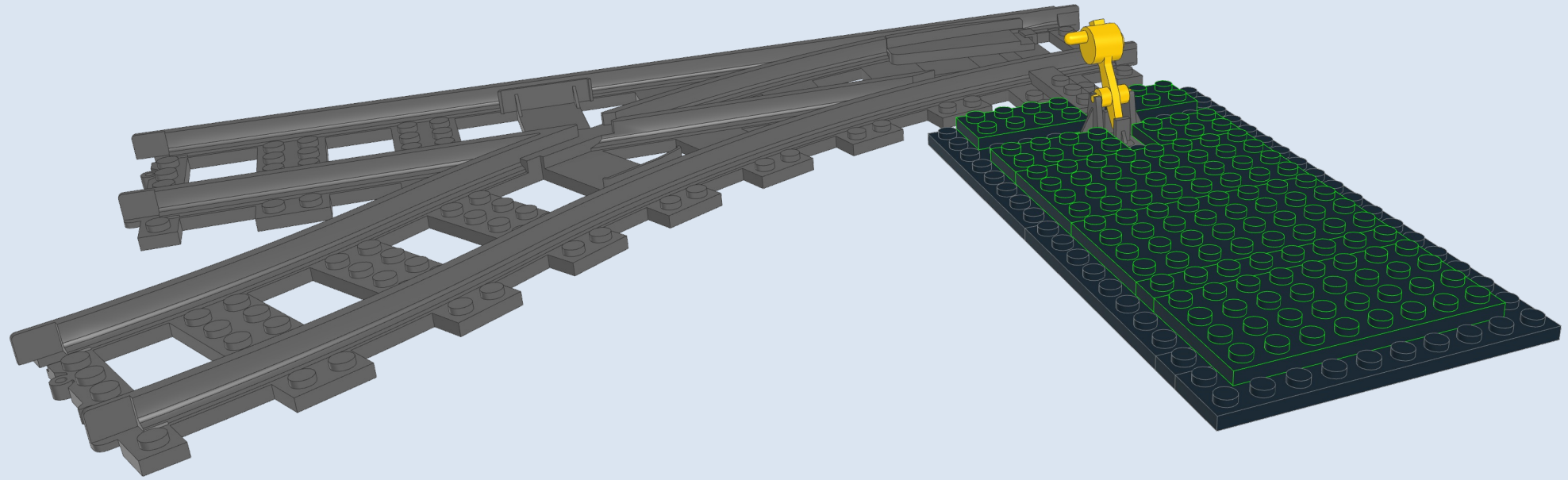
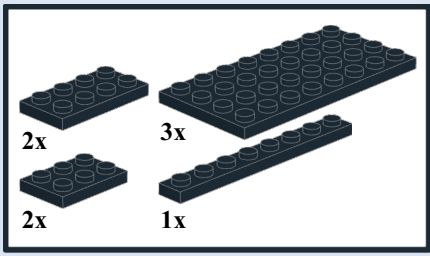

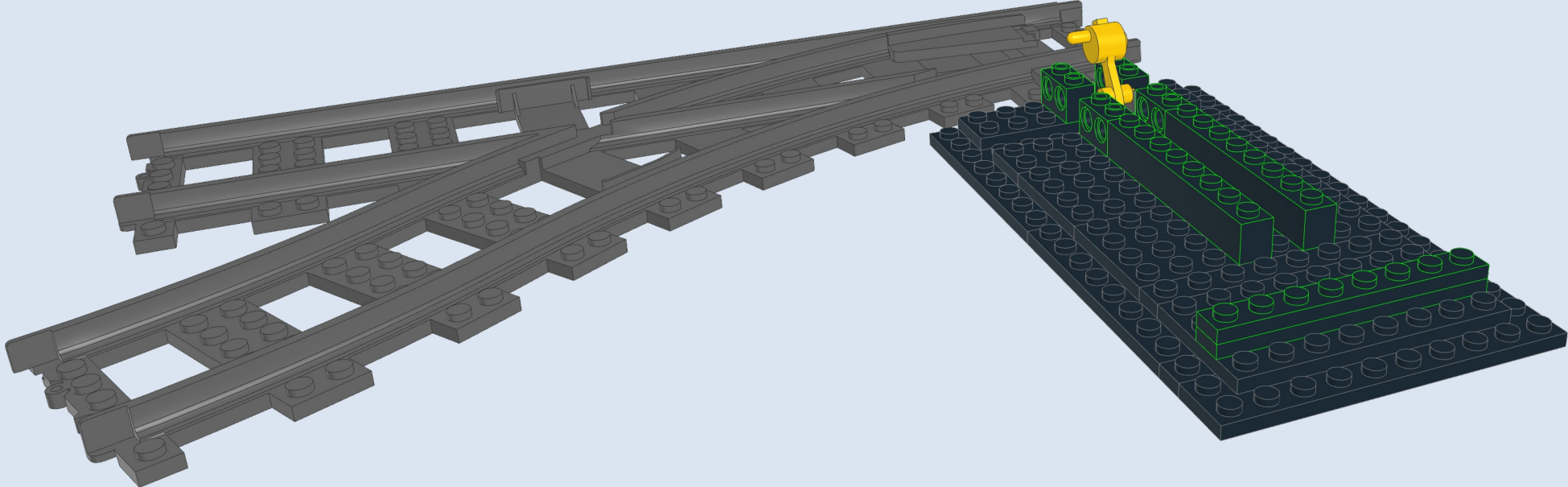
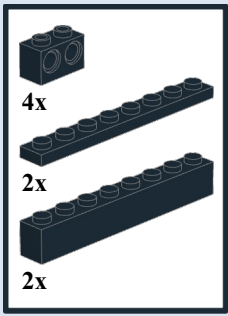

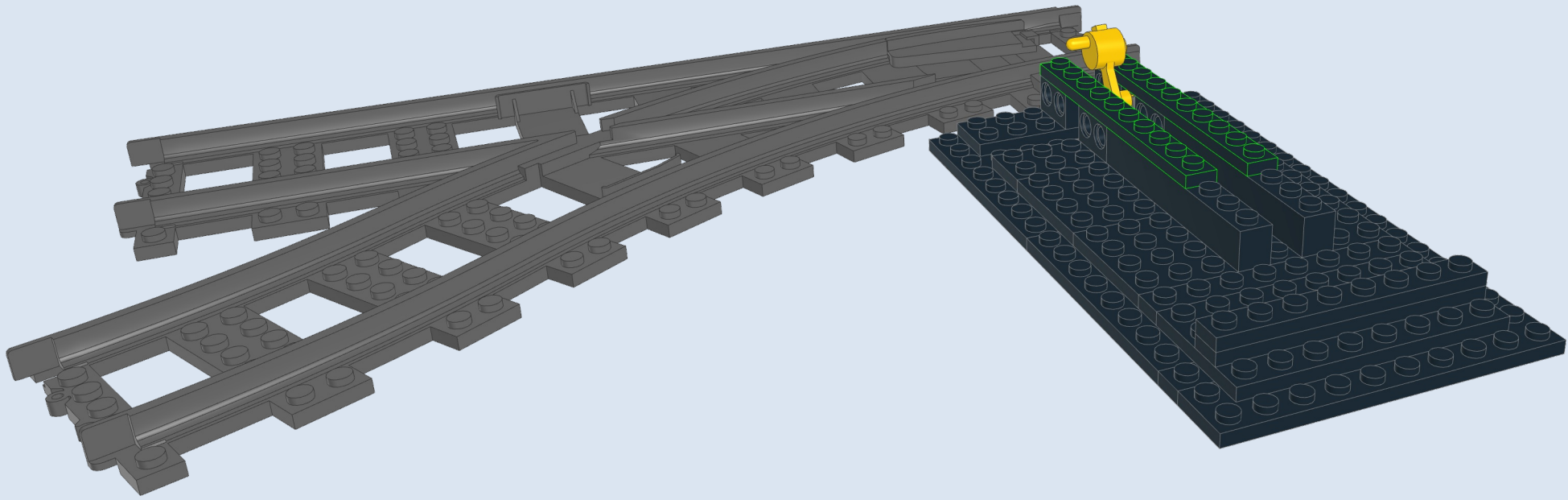
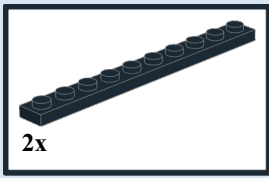

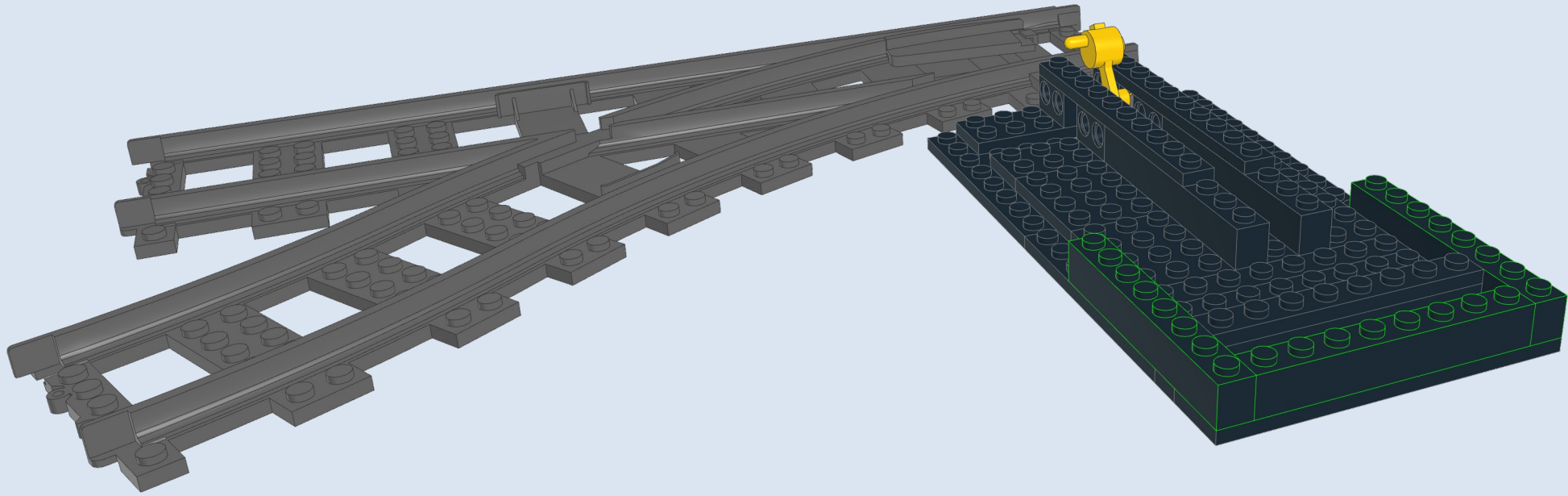
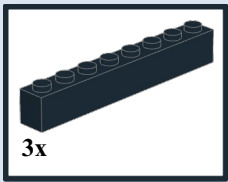

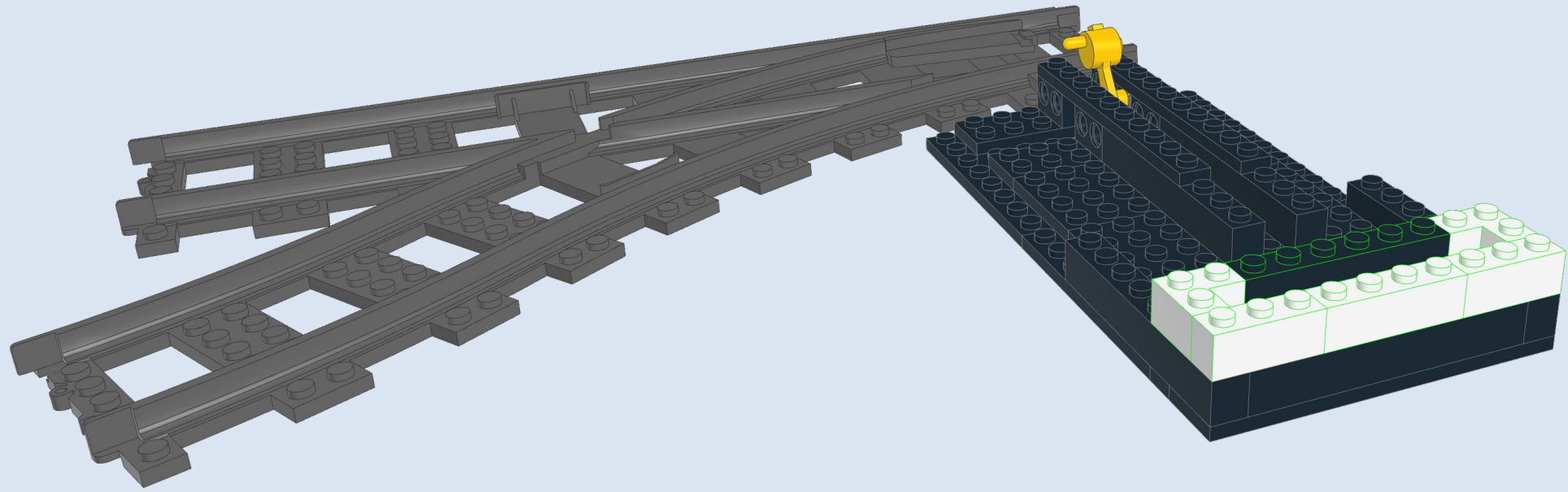
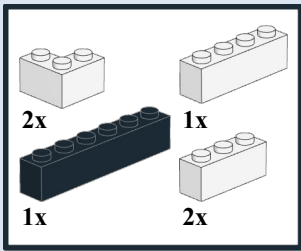

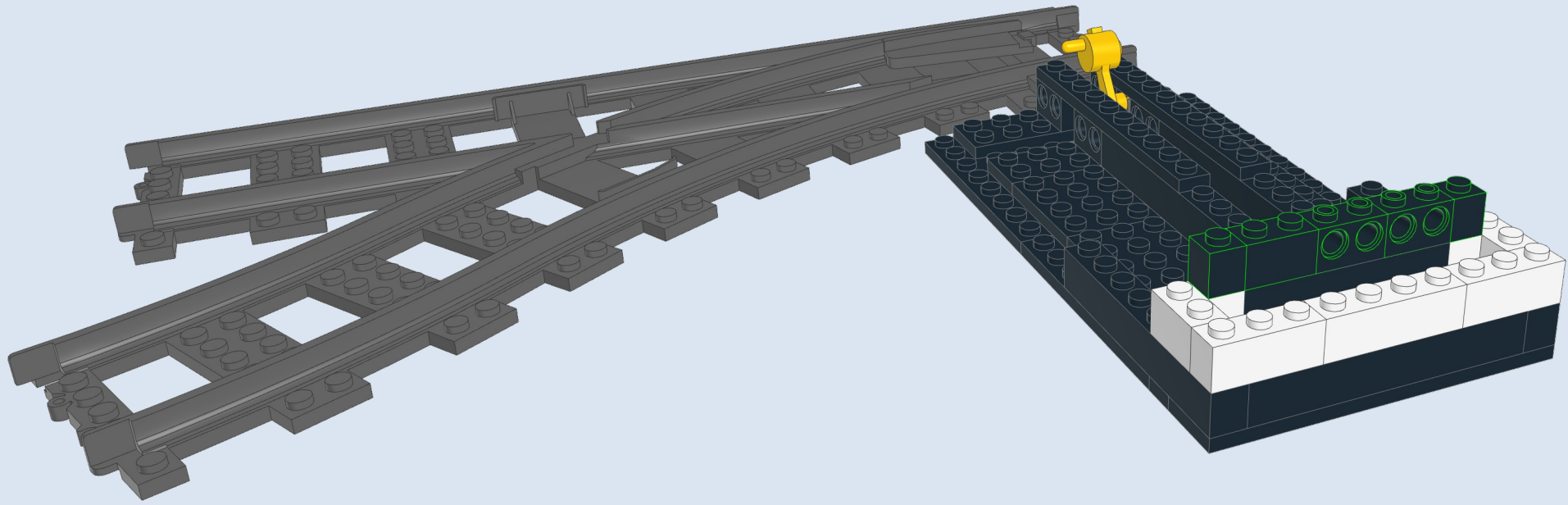
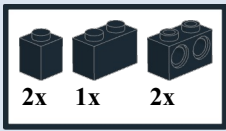

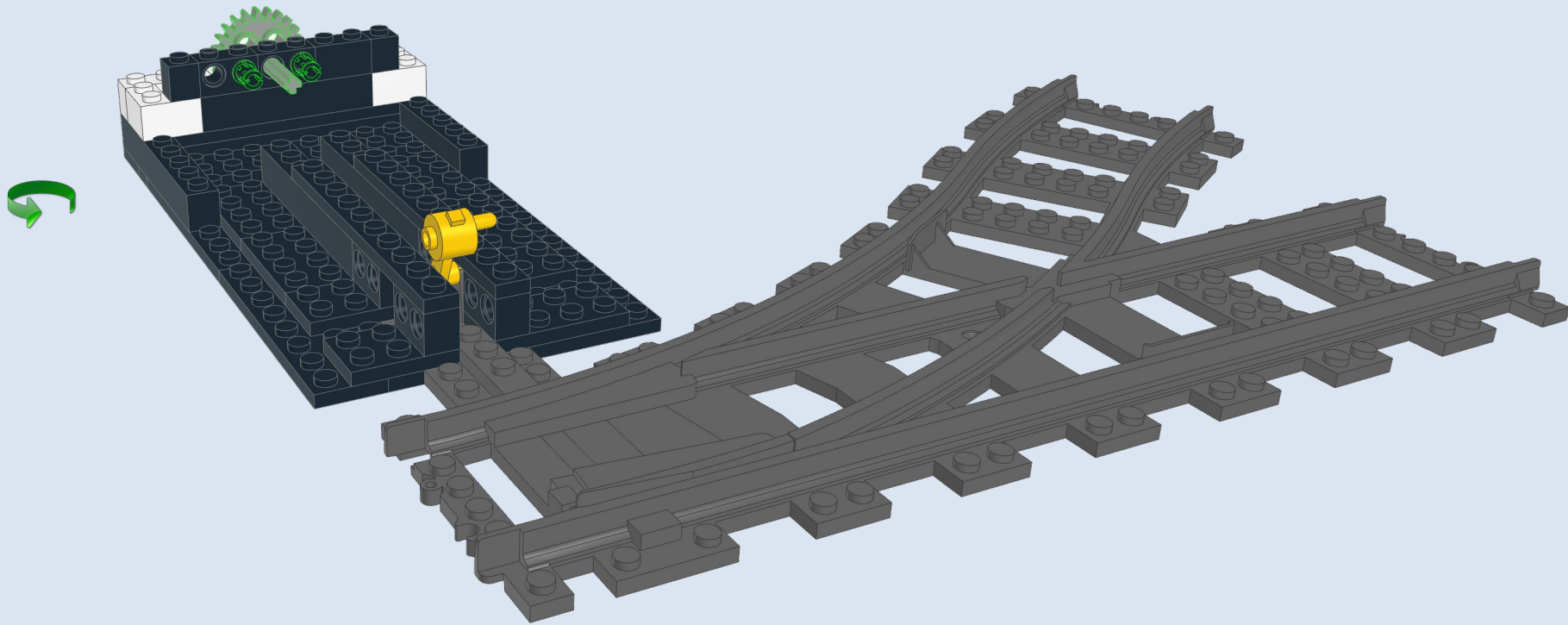
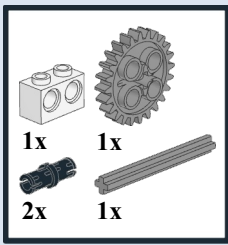

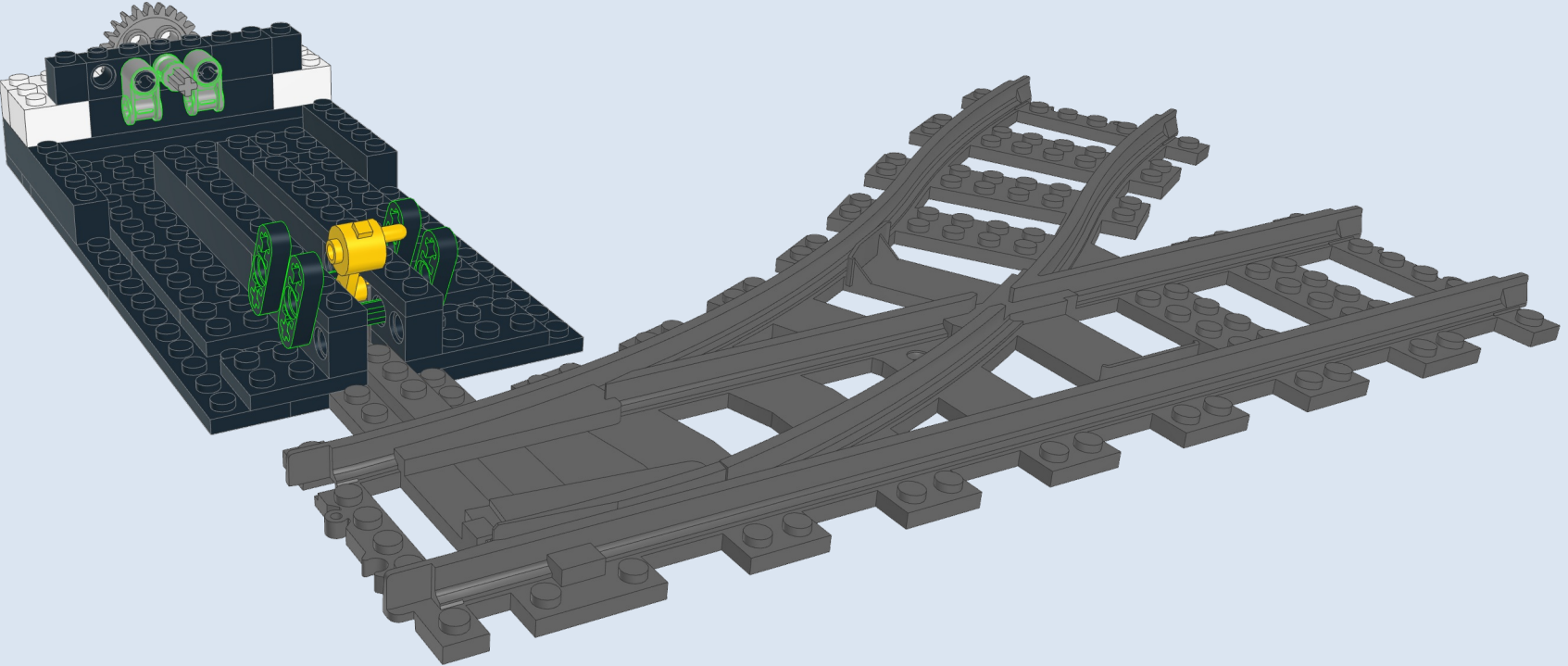
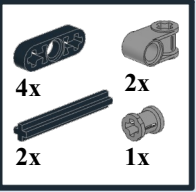

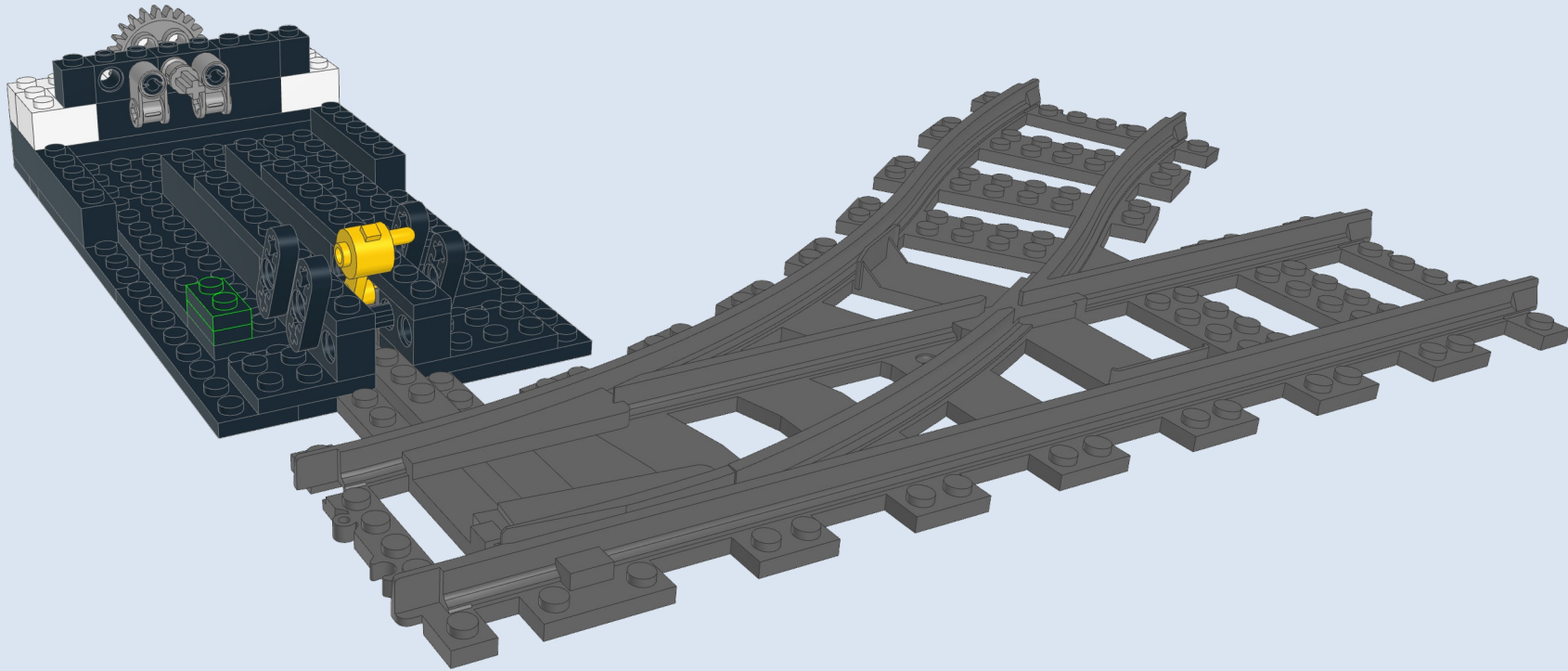

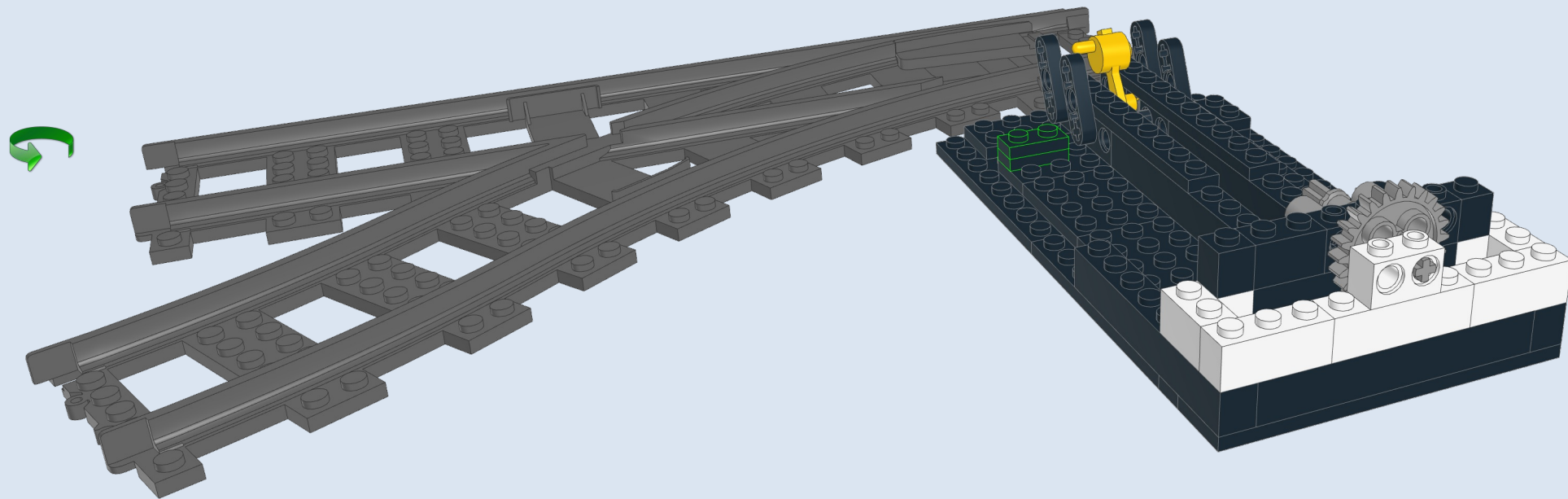

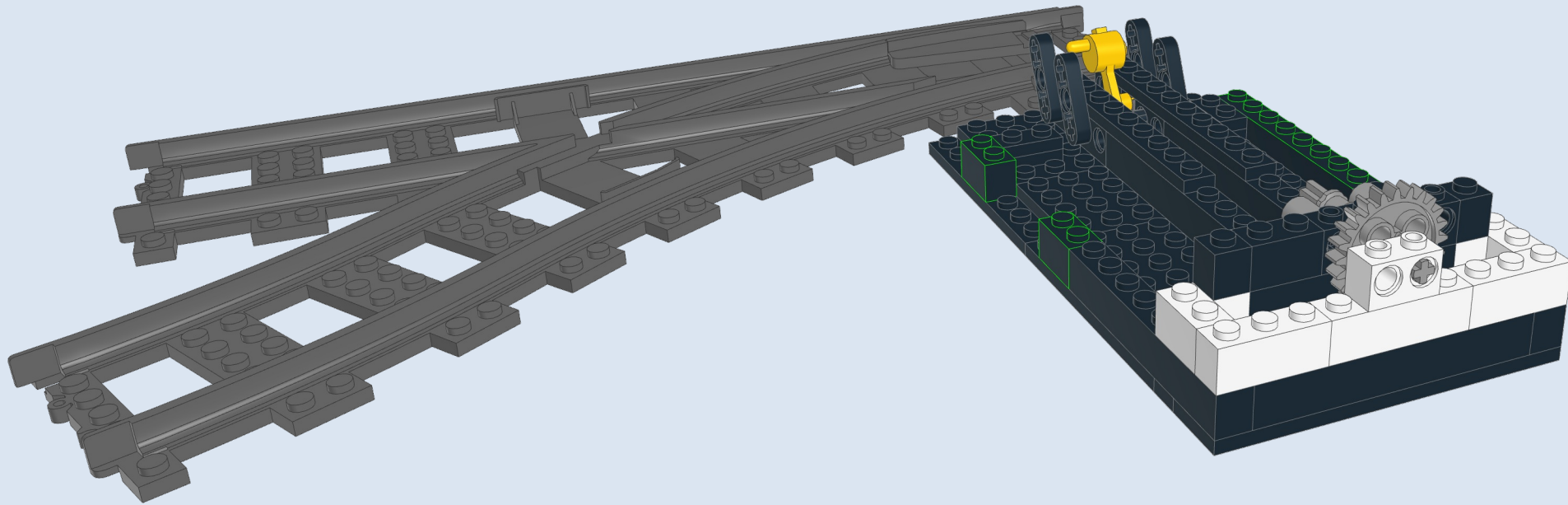
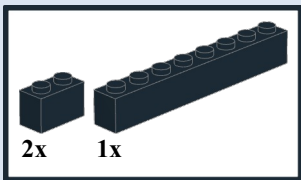

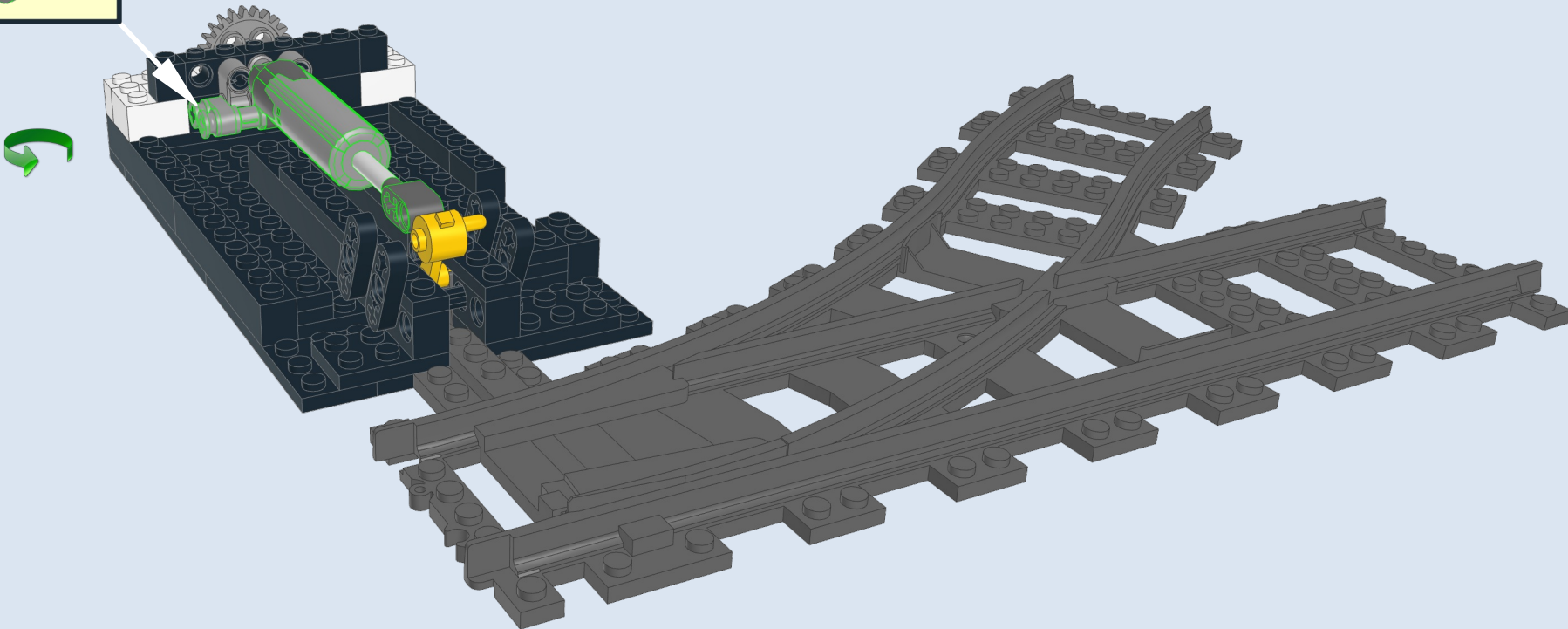
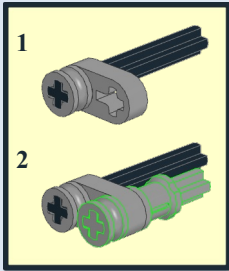
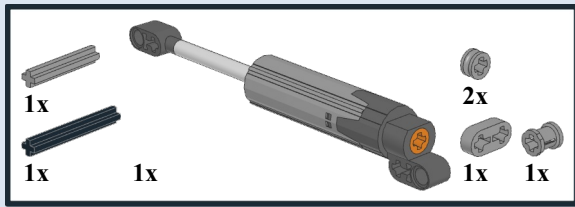

- 1x
- 1x
- 1x
- 2x
- 1x

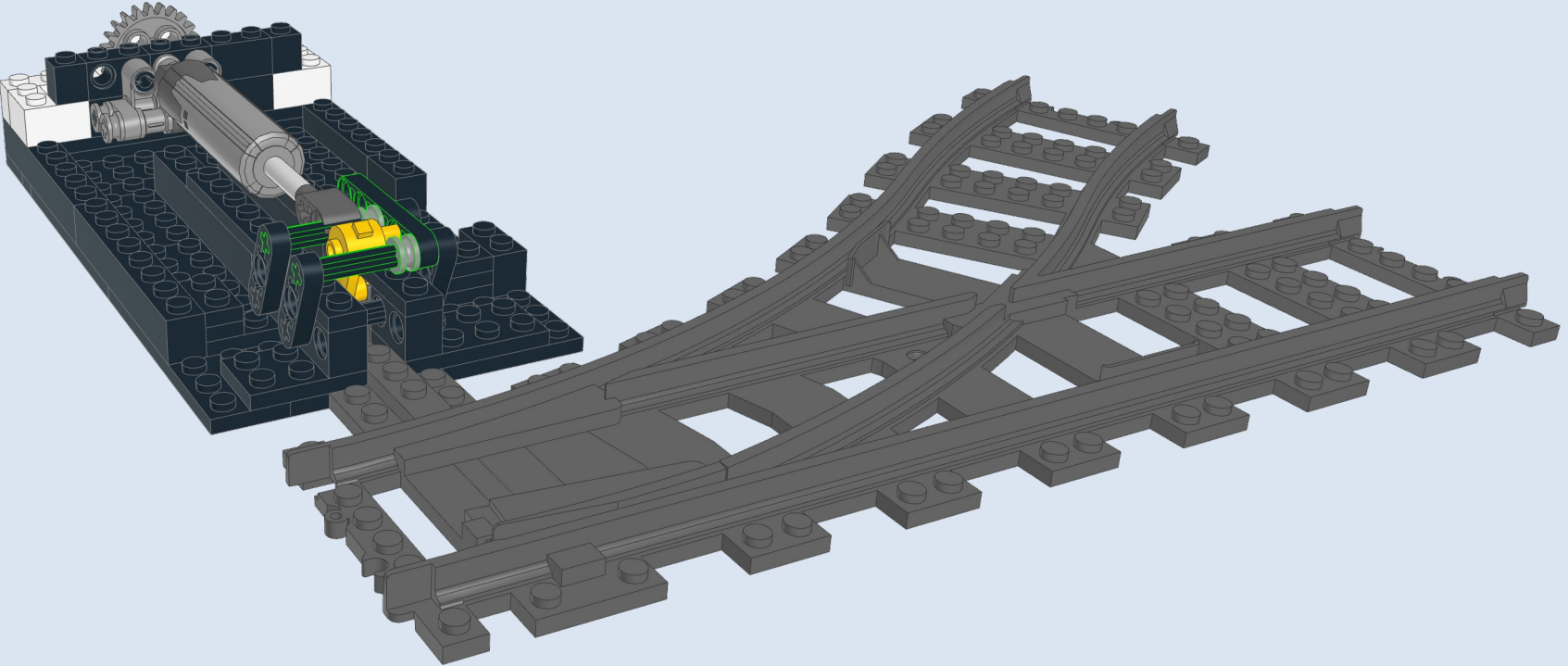

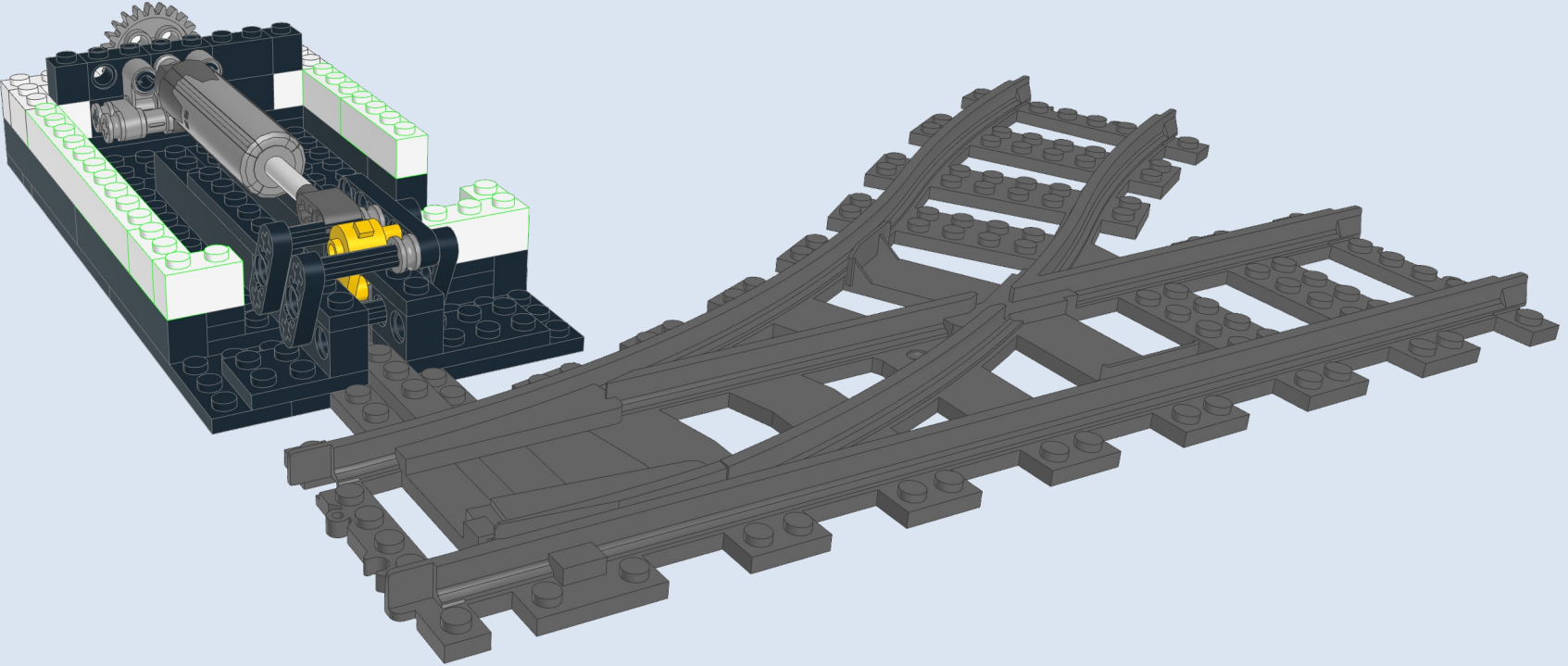
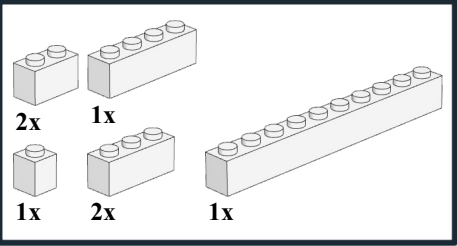

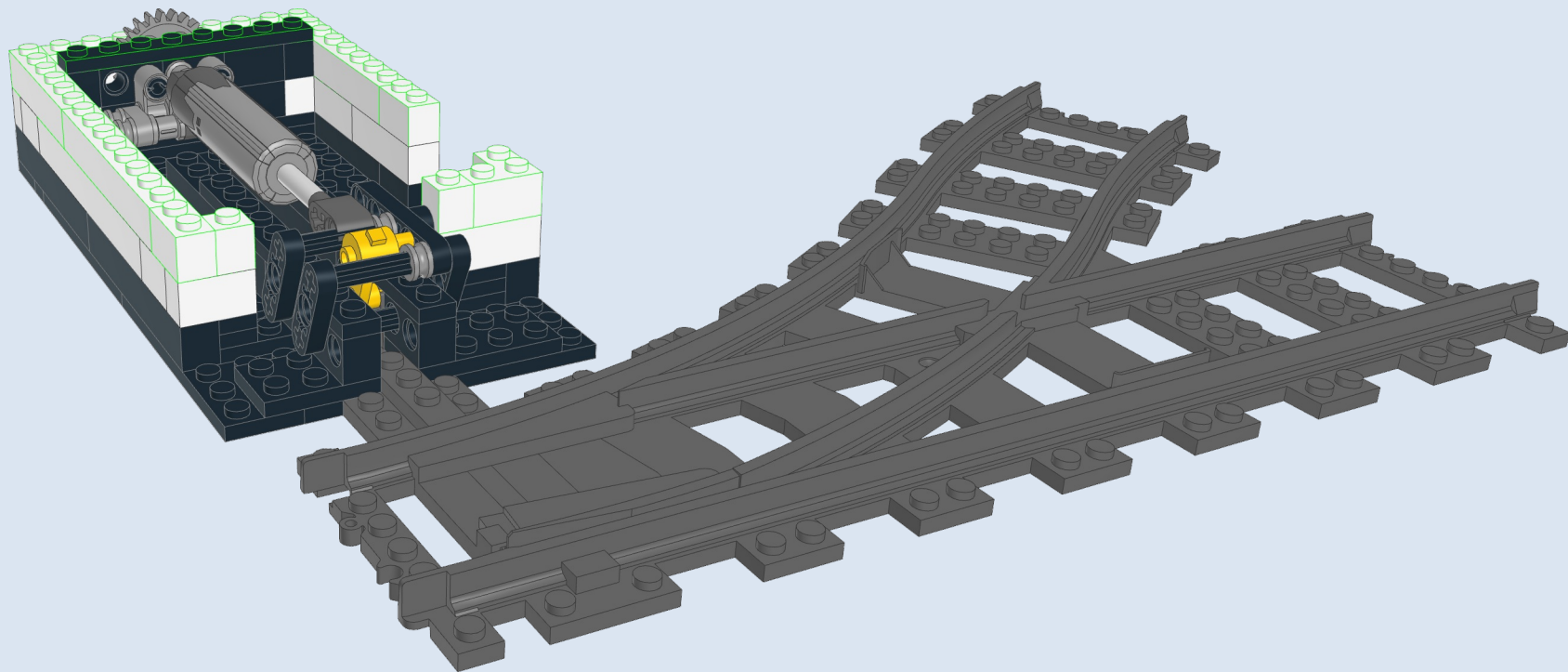
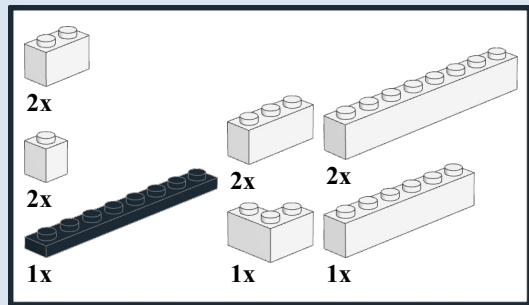

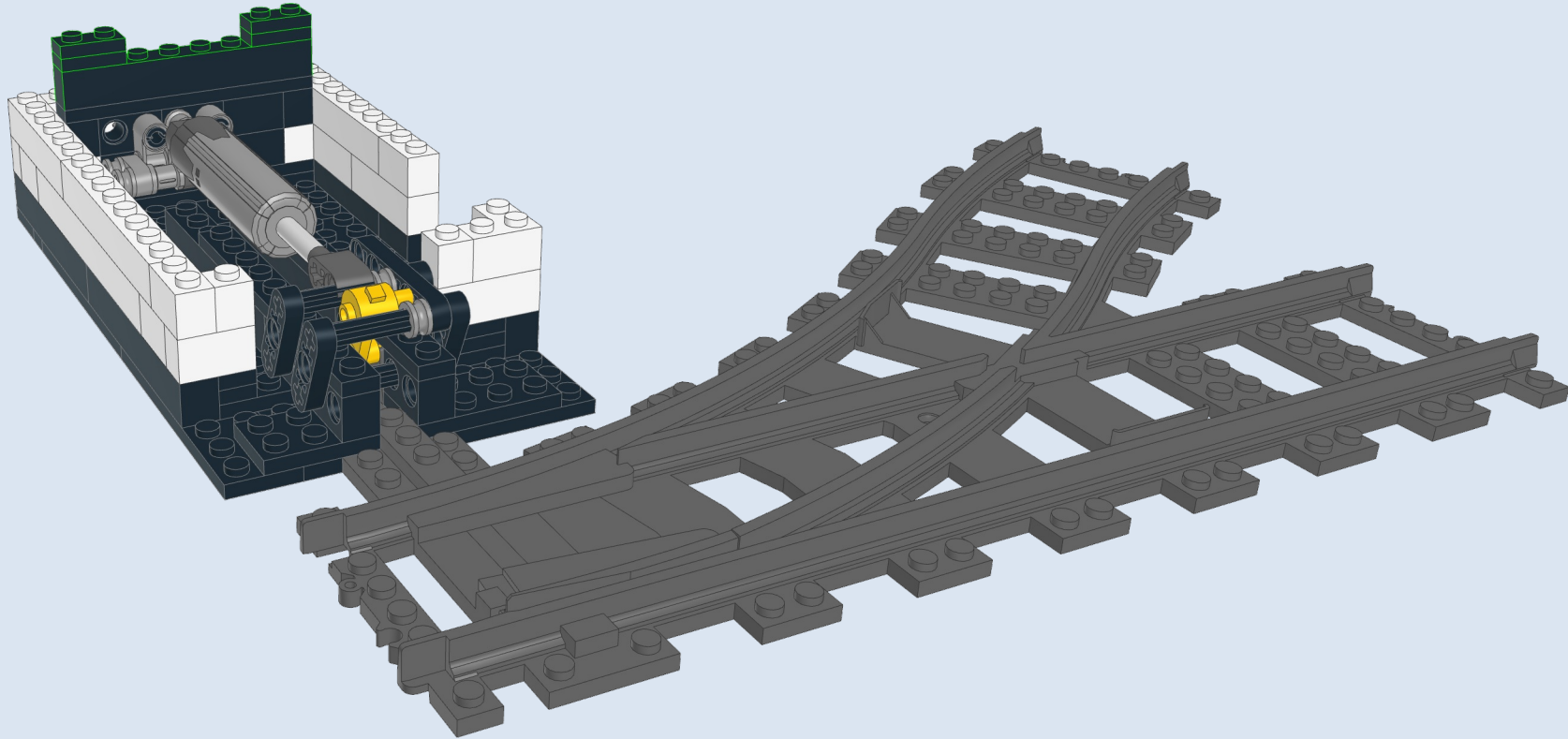
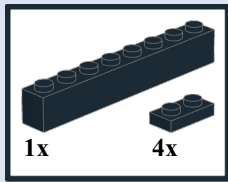

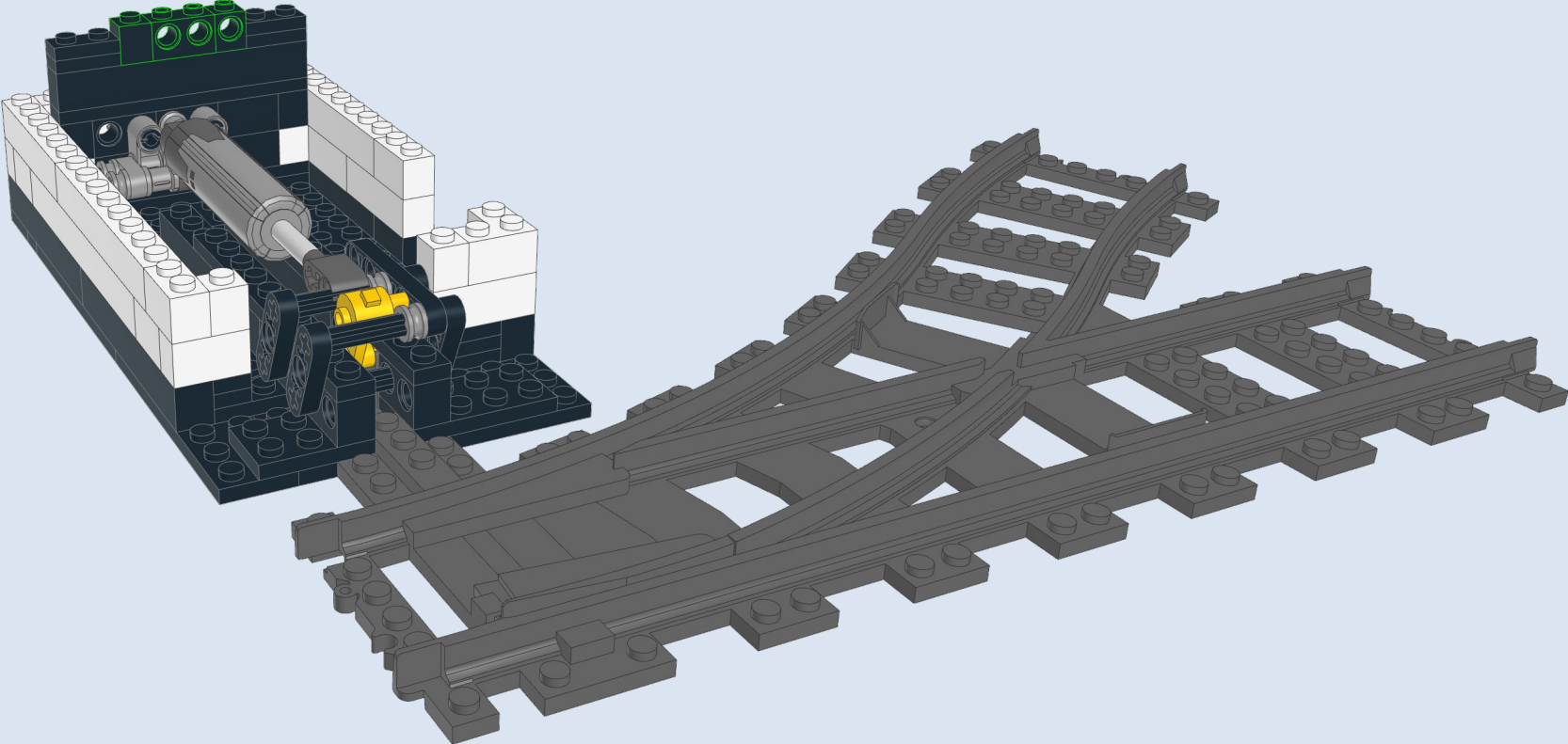
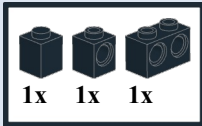

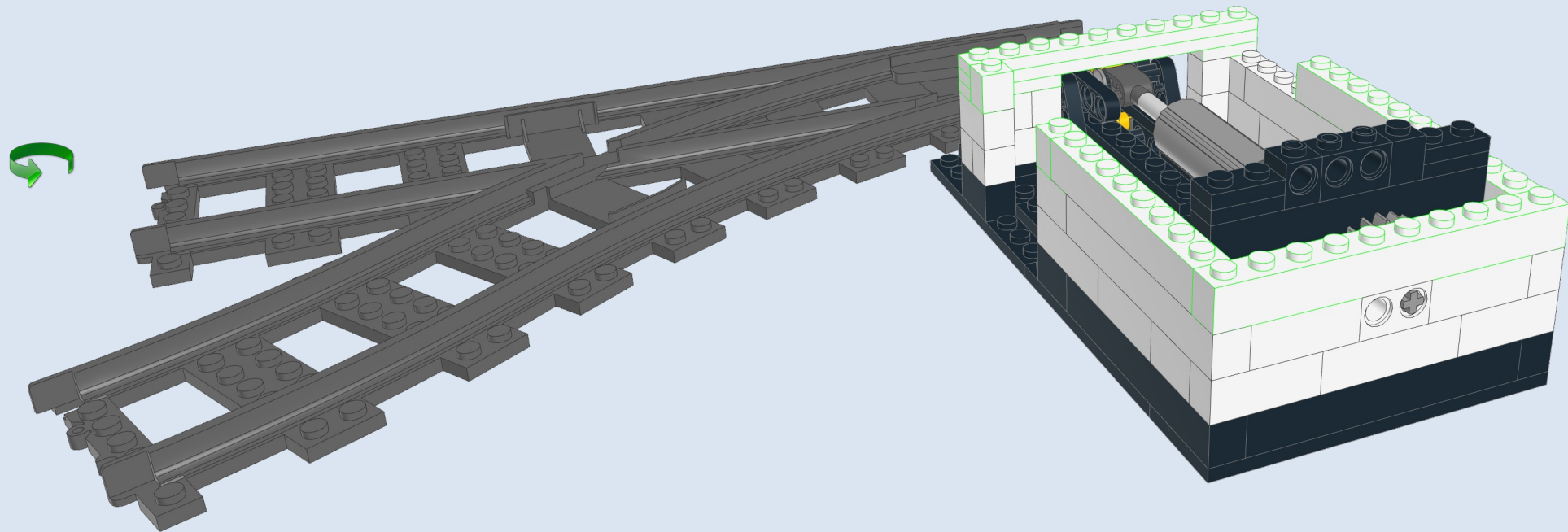
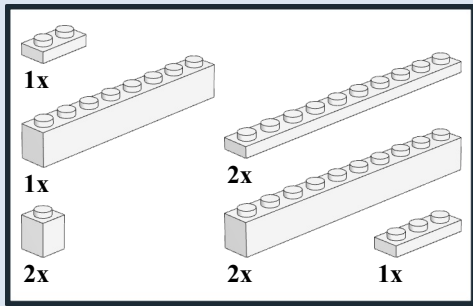

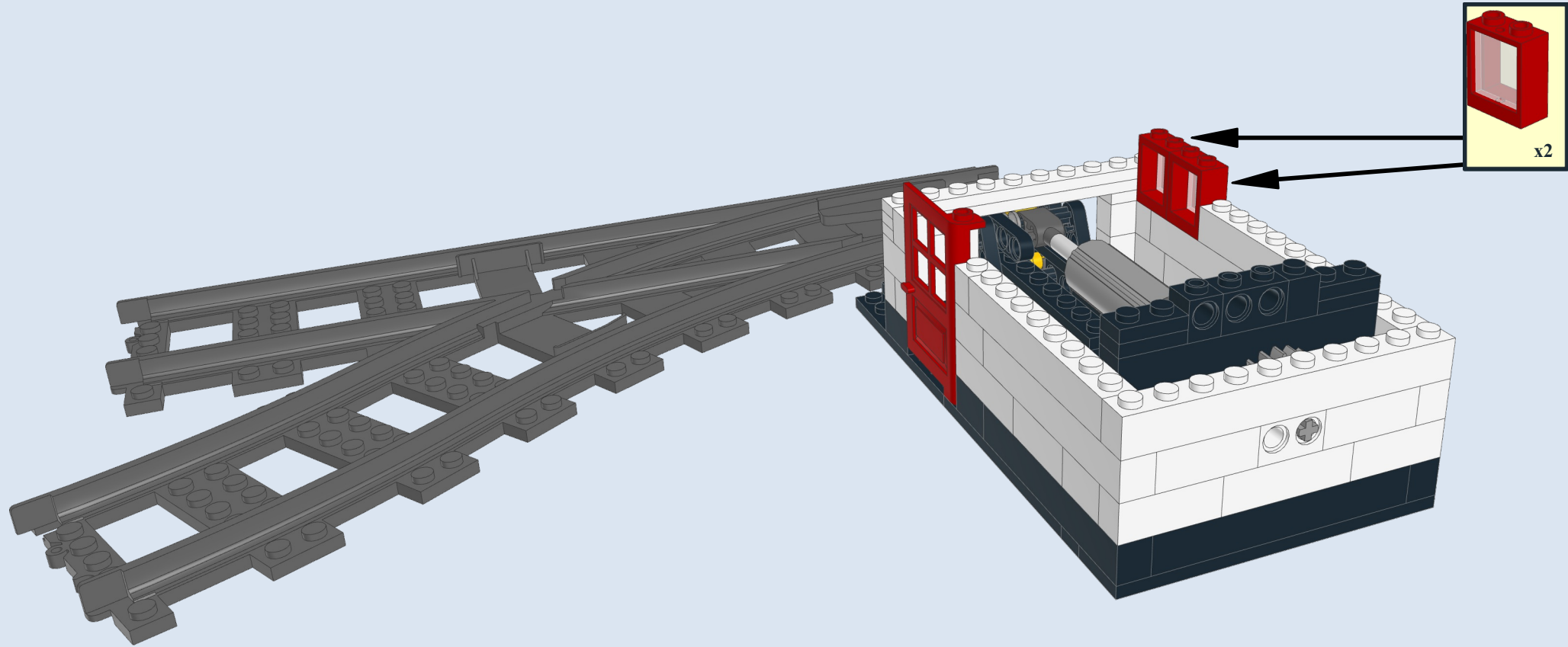
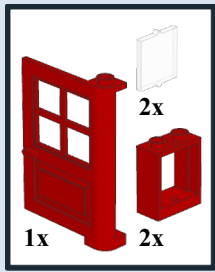

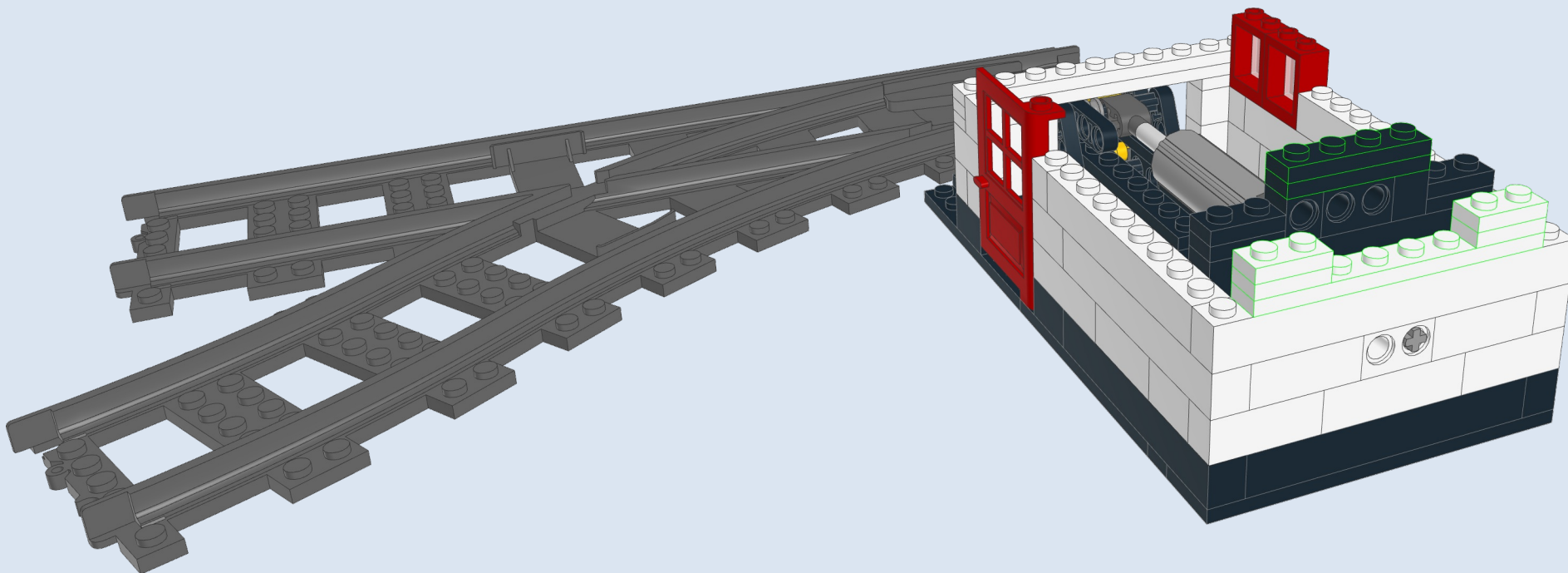
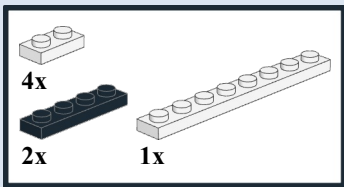

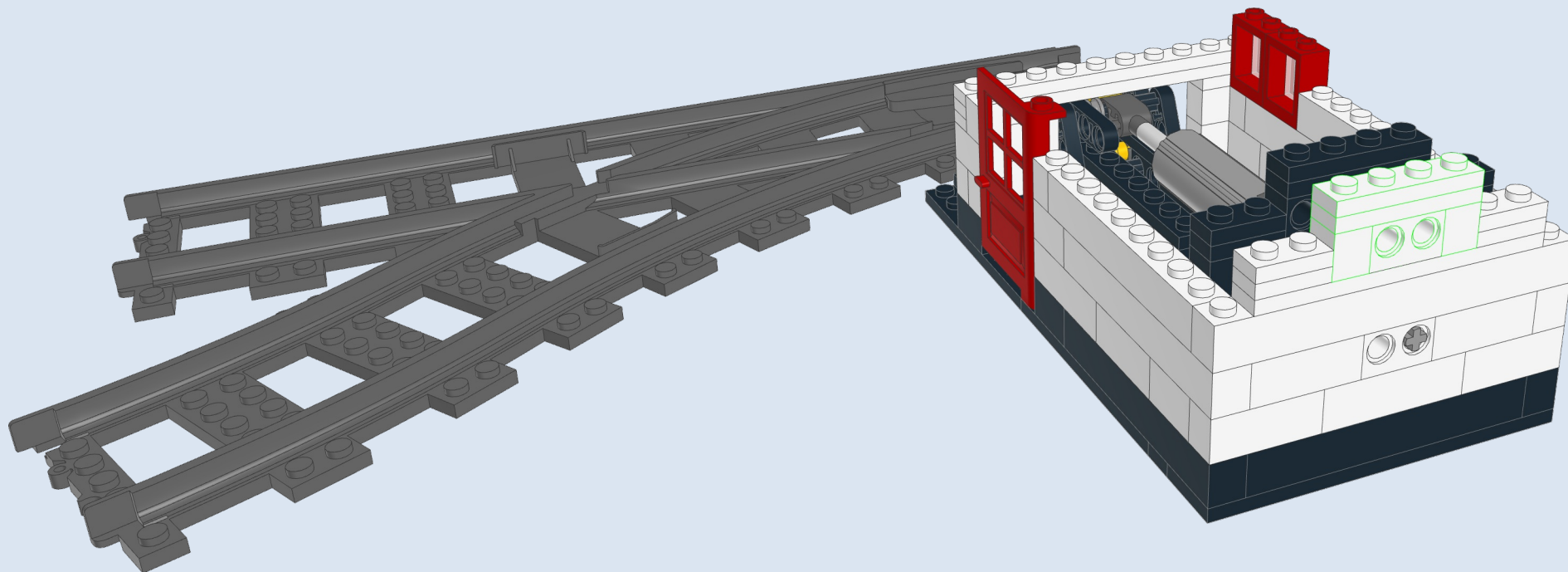
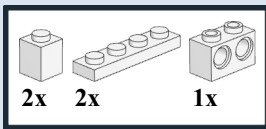

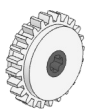



-  1x
-  1x
-  1x
-  2x

