

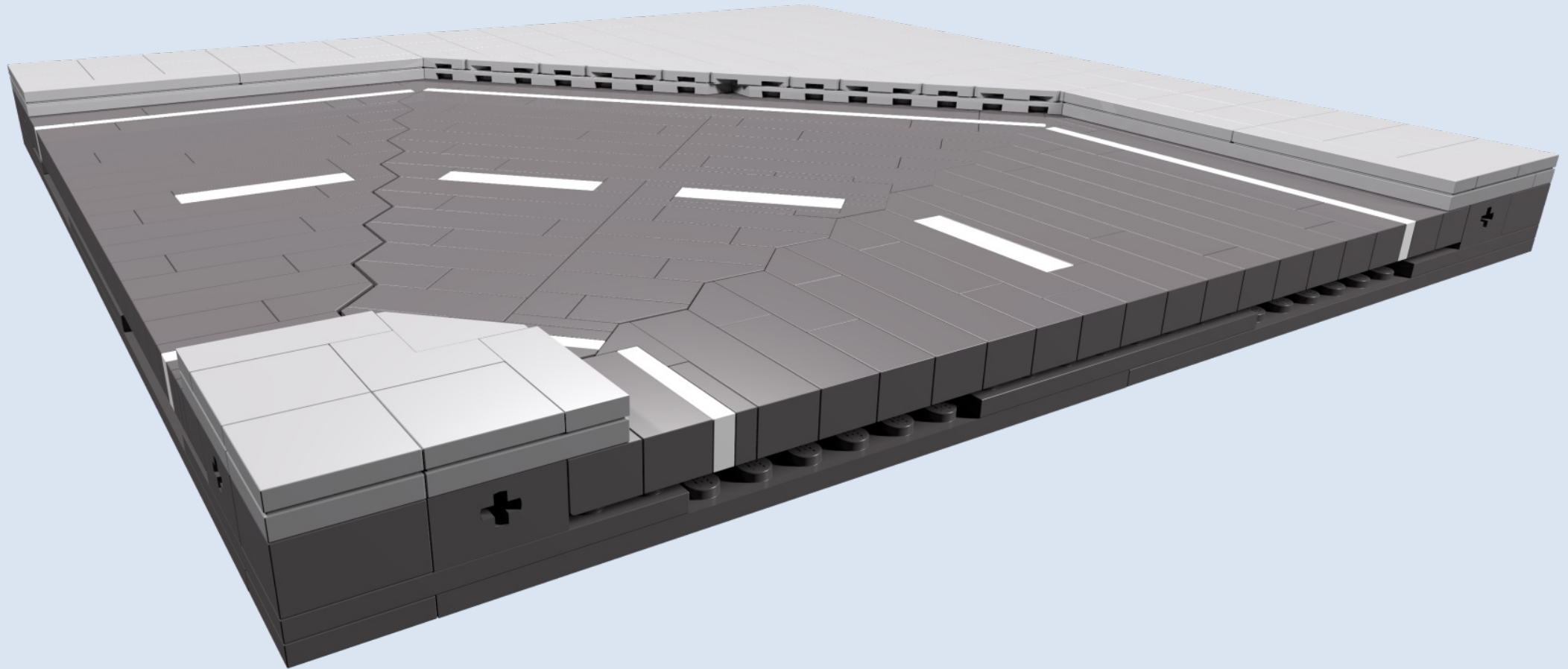

# Moduverse Road Angular Turn

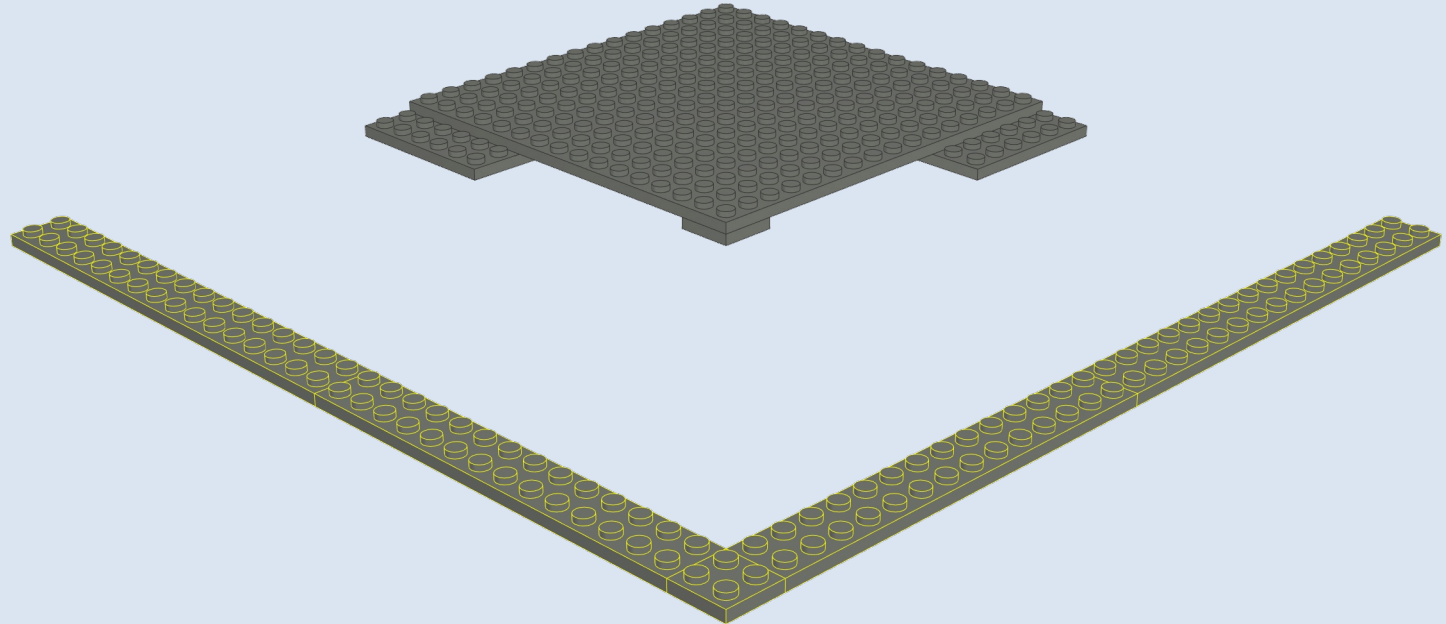

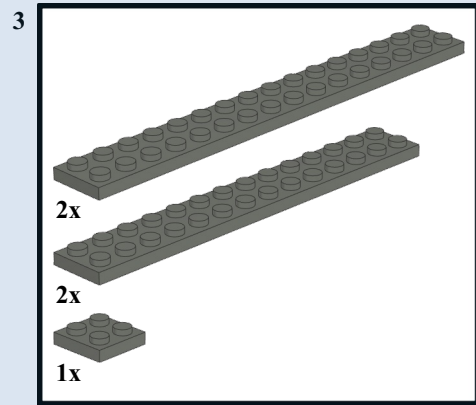
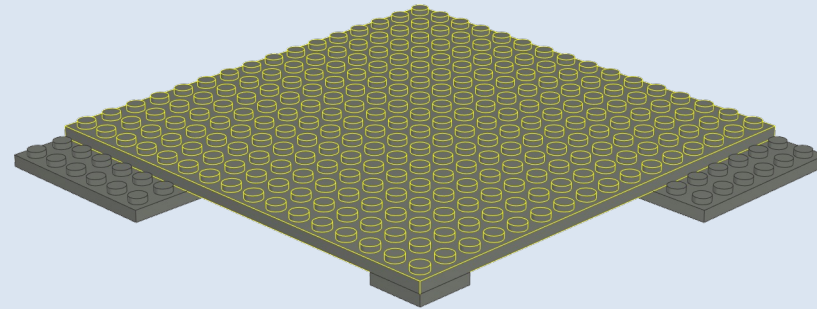
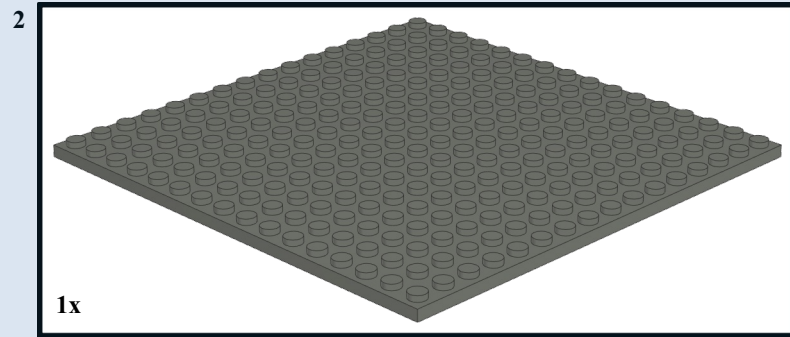
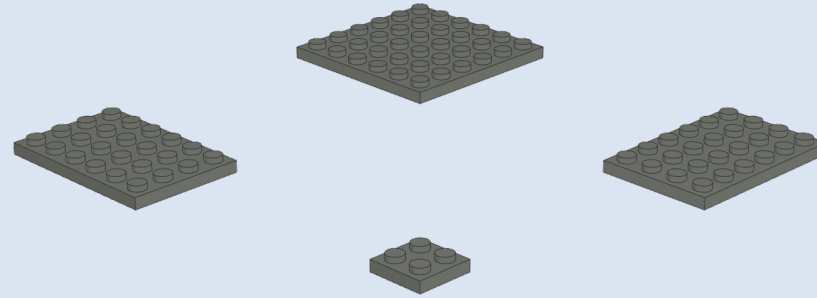
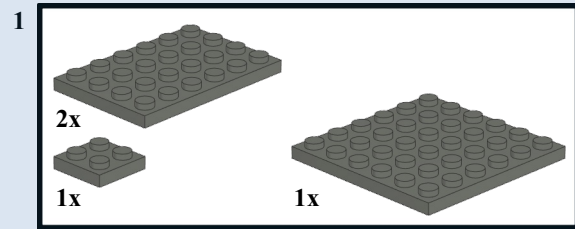
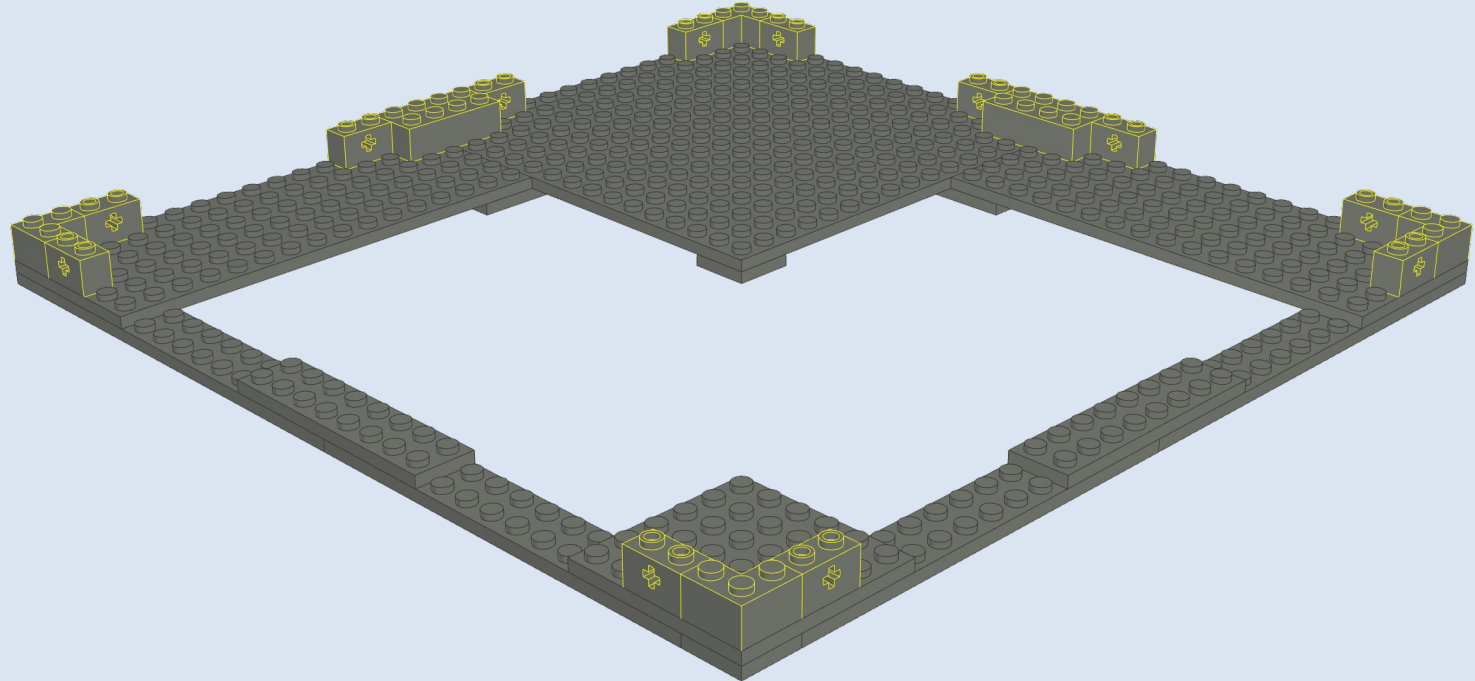
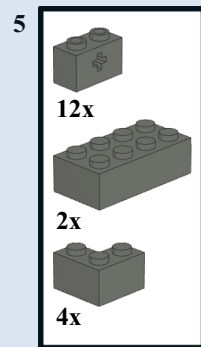
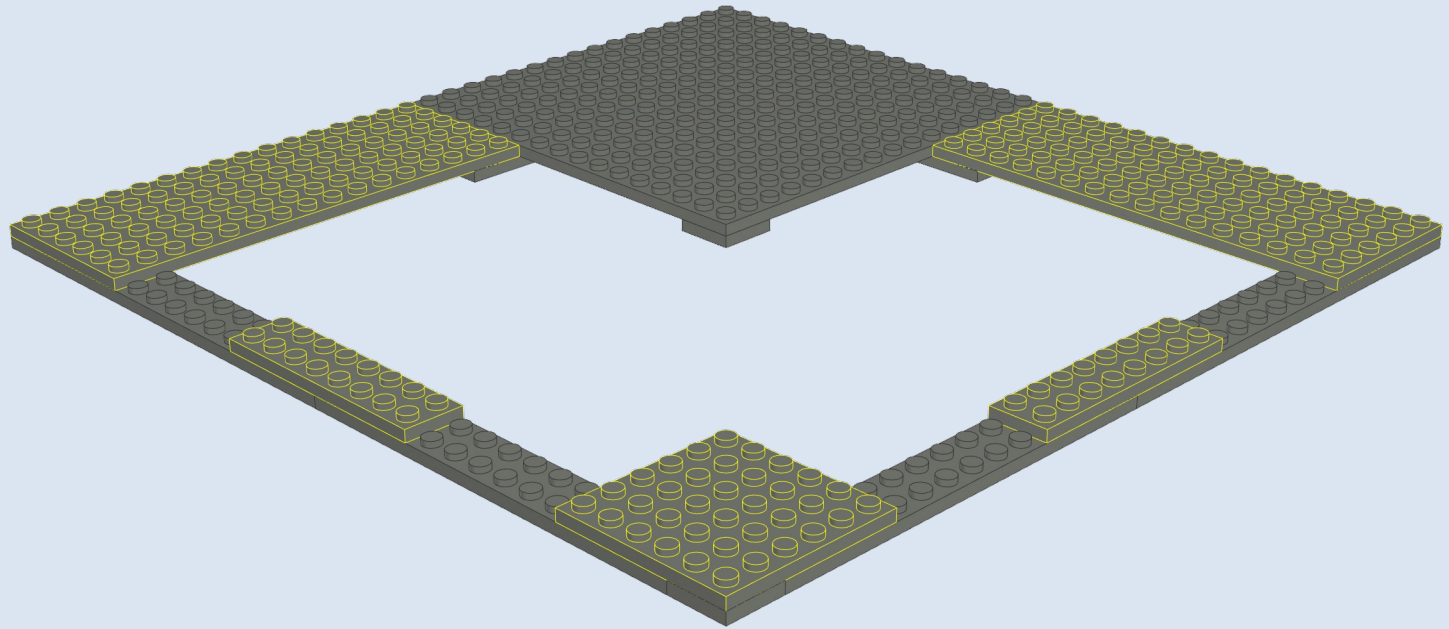
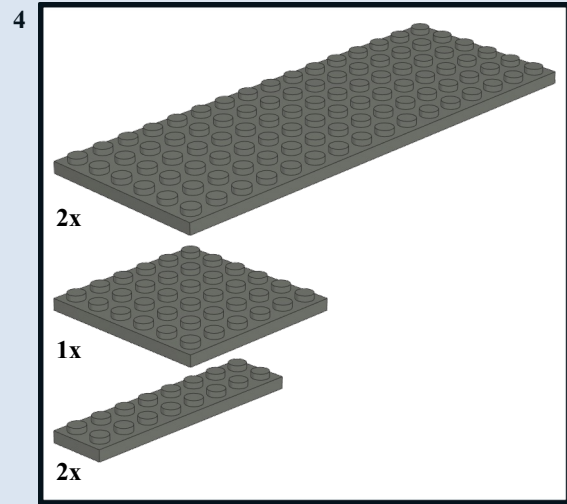

Based on the Moduverse Standard by the LEGO User Group in Finland Palikkatakomo

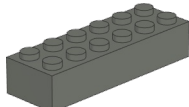
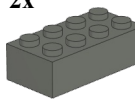
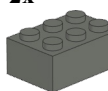

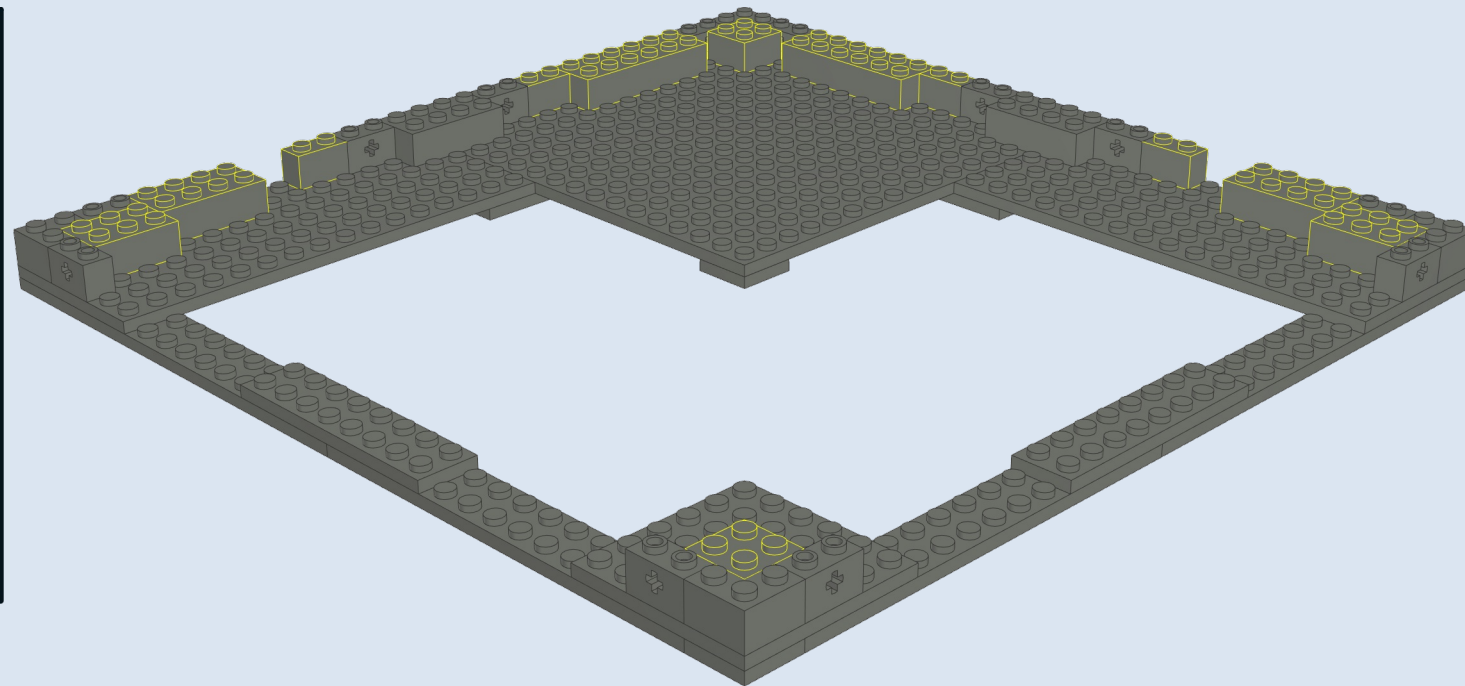

- 6
-  2x
  -  2x
  -  2x
  -  2x
  -  4x

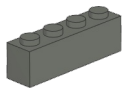
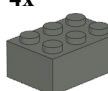

- 7
-  4x
  -  2x
  -  1x

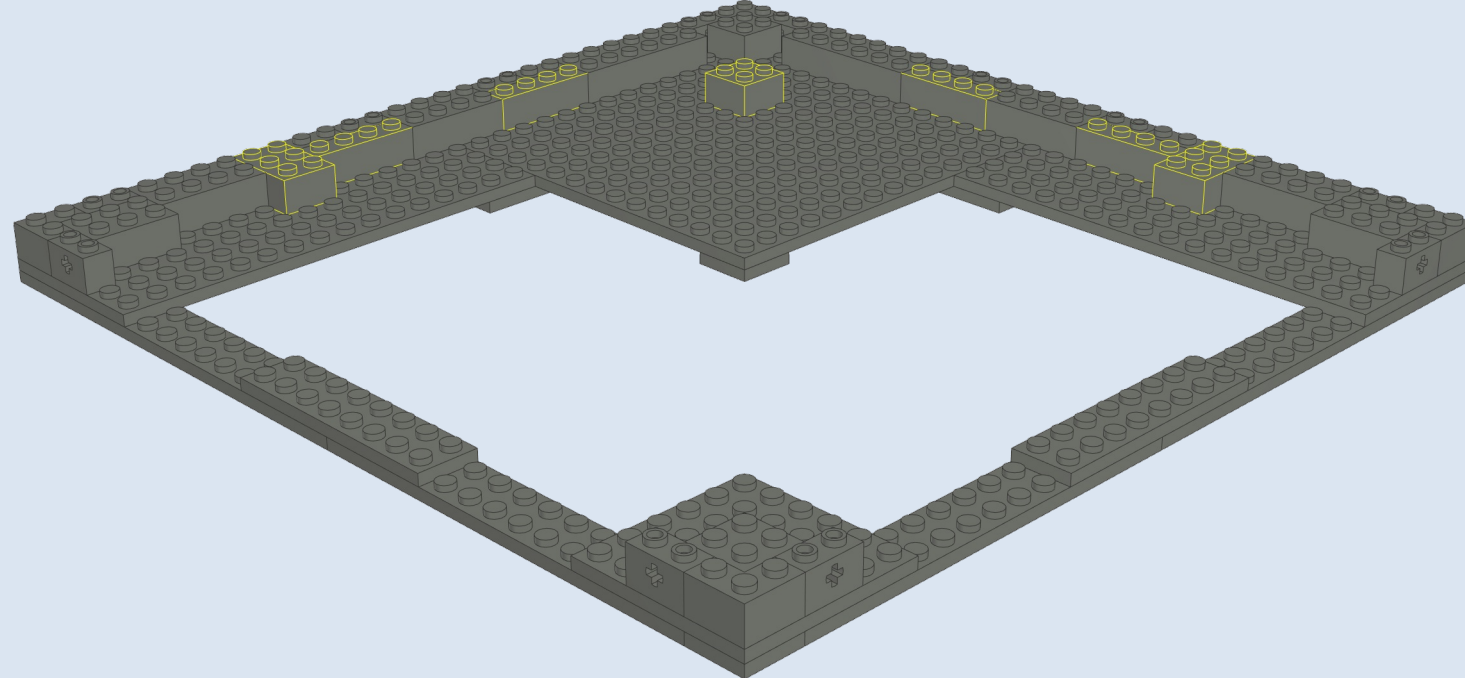

8

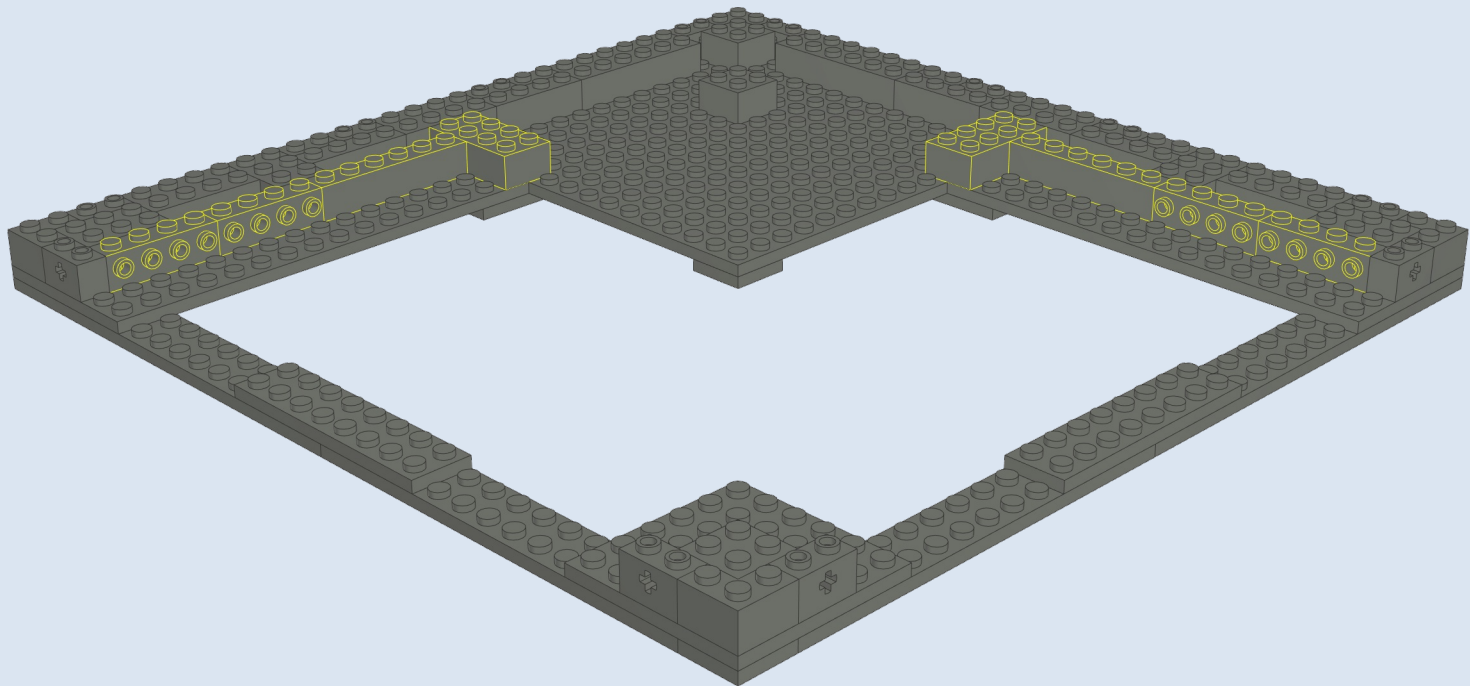
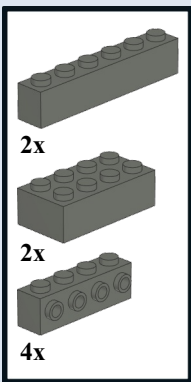

9

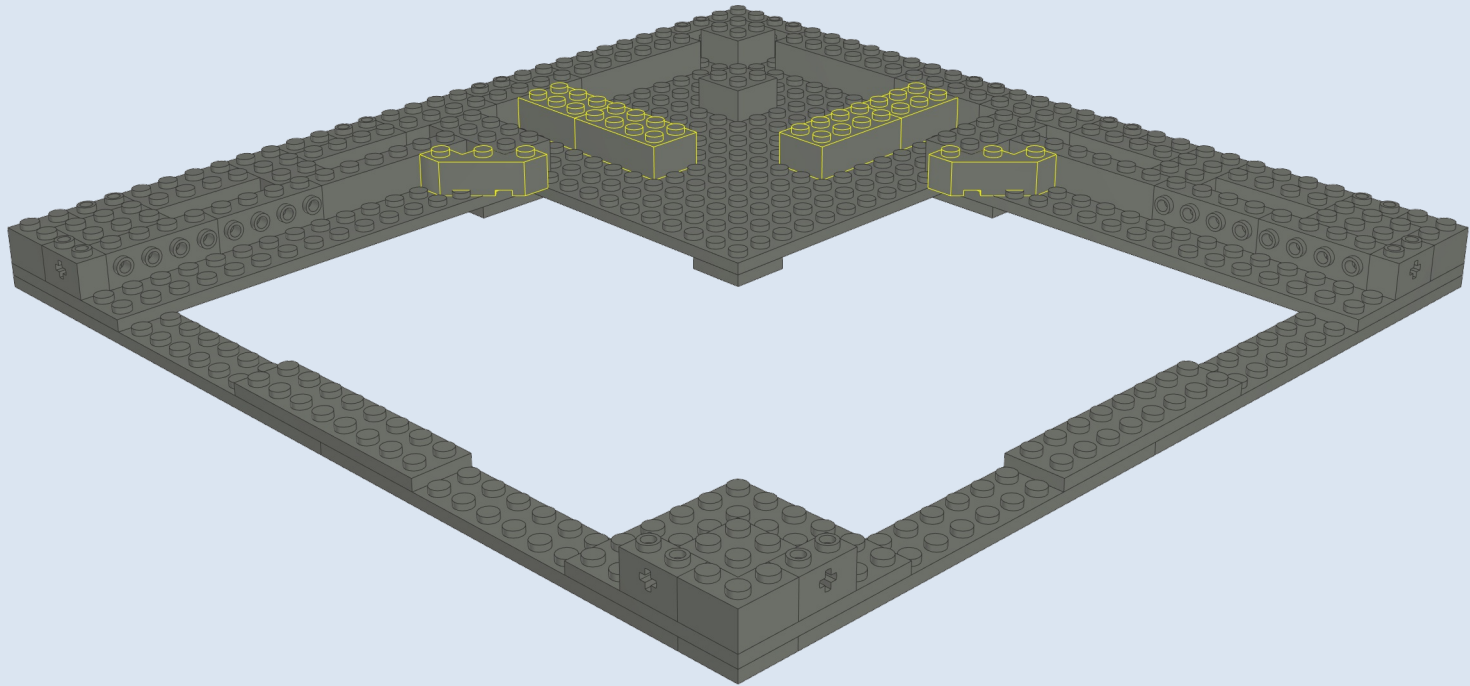
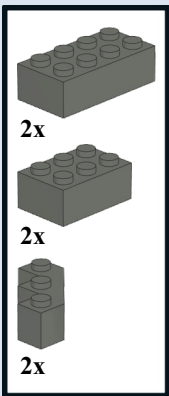

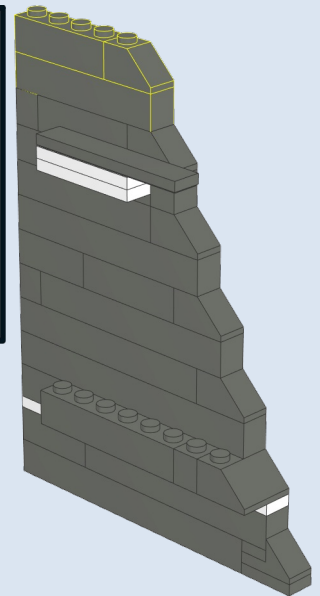
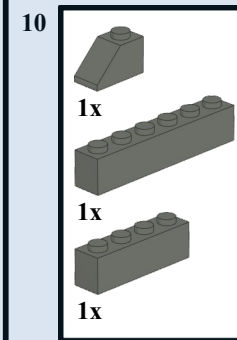
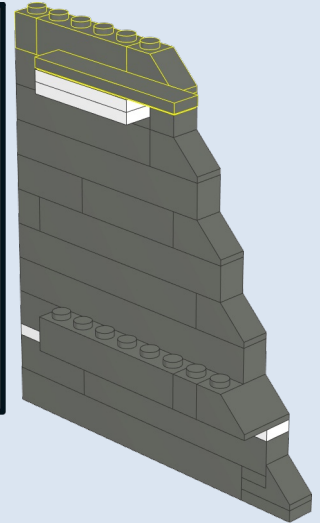
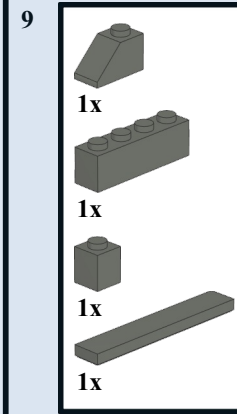
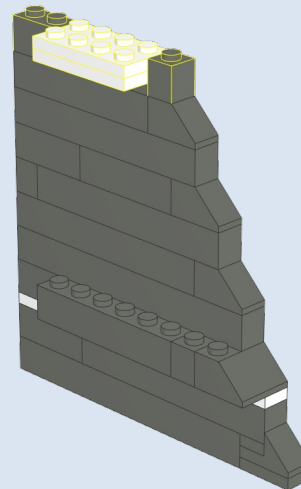
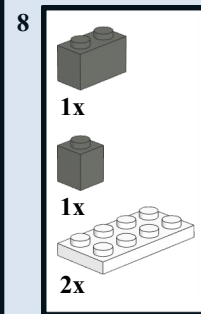
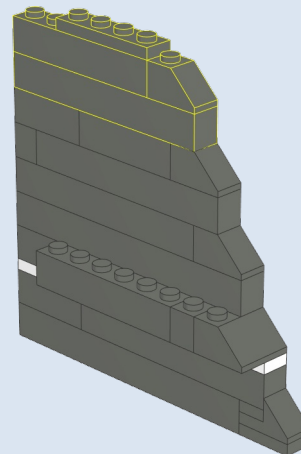
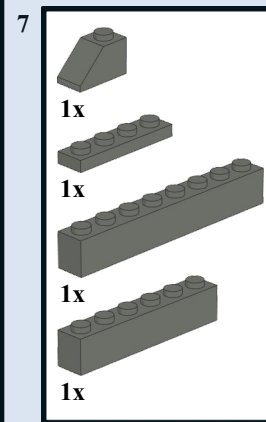
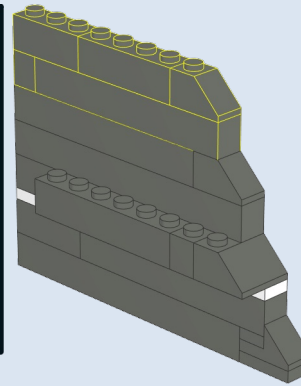
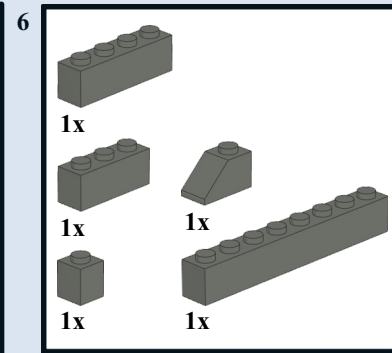
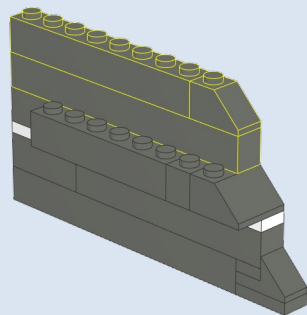
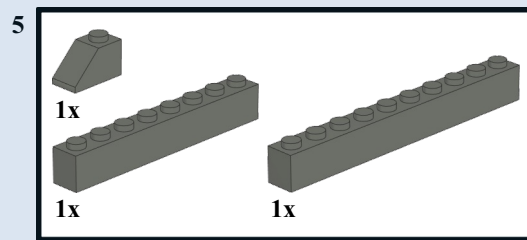
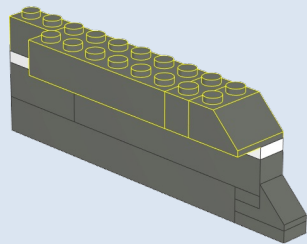
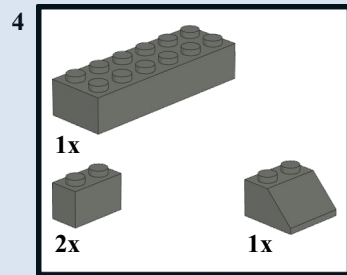
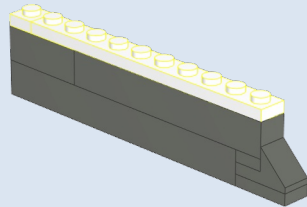
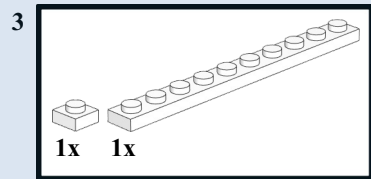
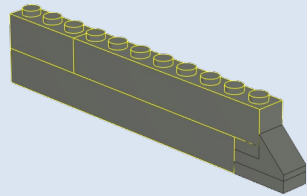
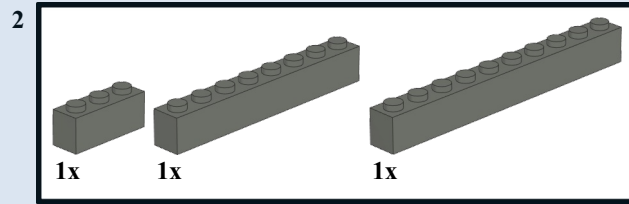
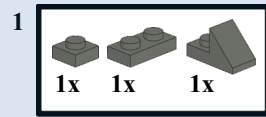

11

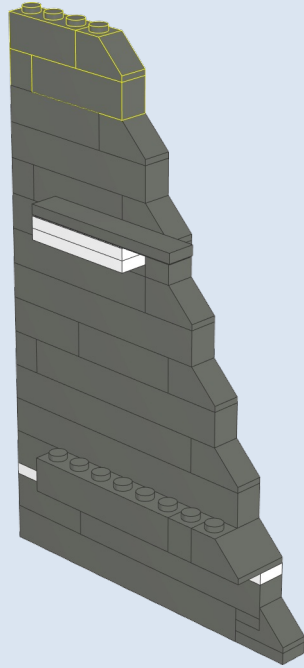
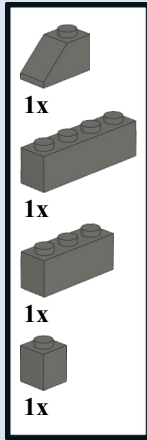

13

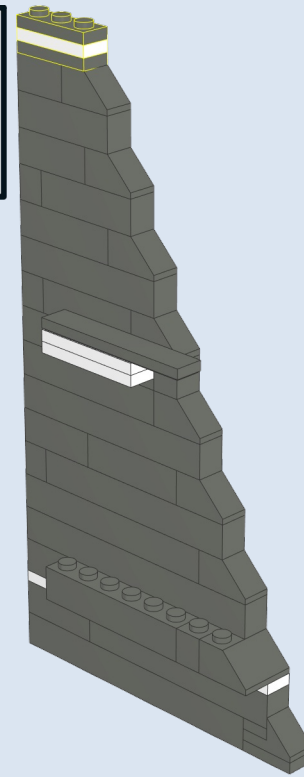
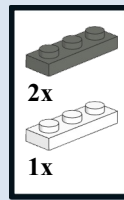

15

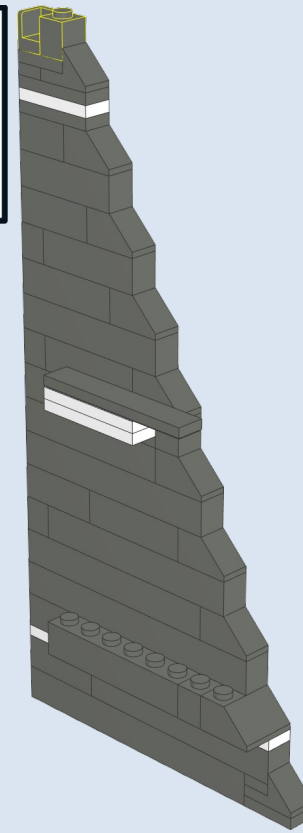
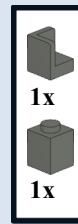

16

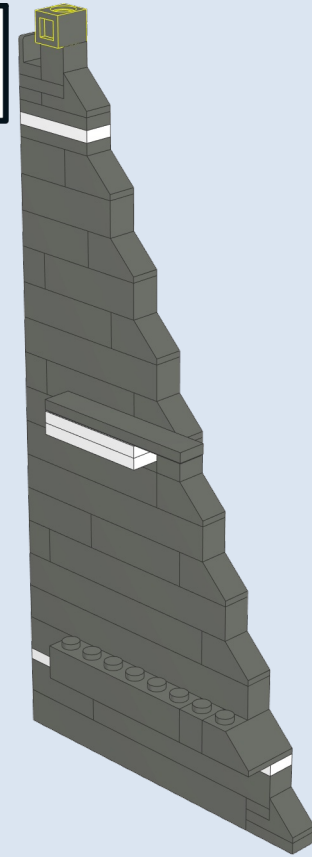
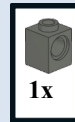

12

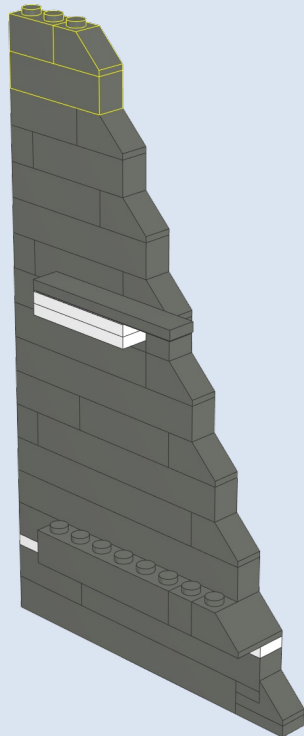
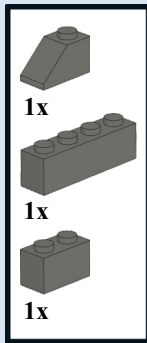

14

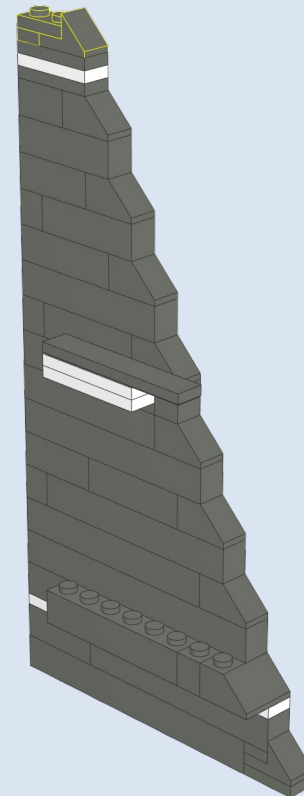
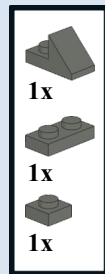

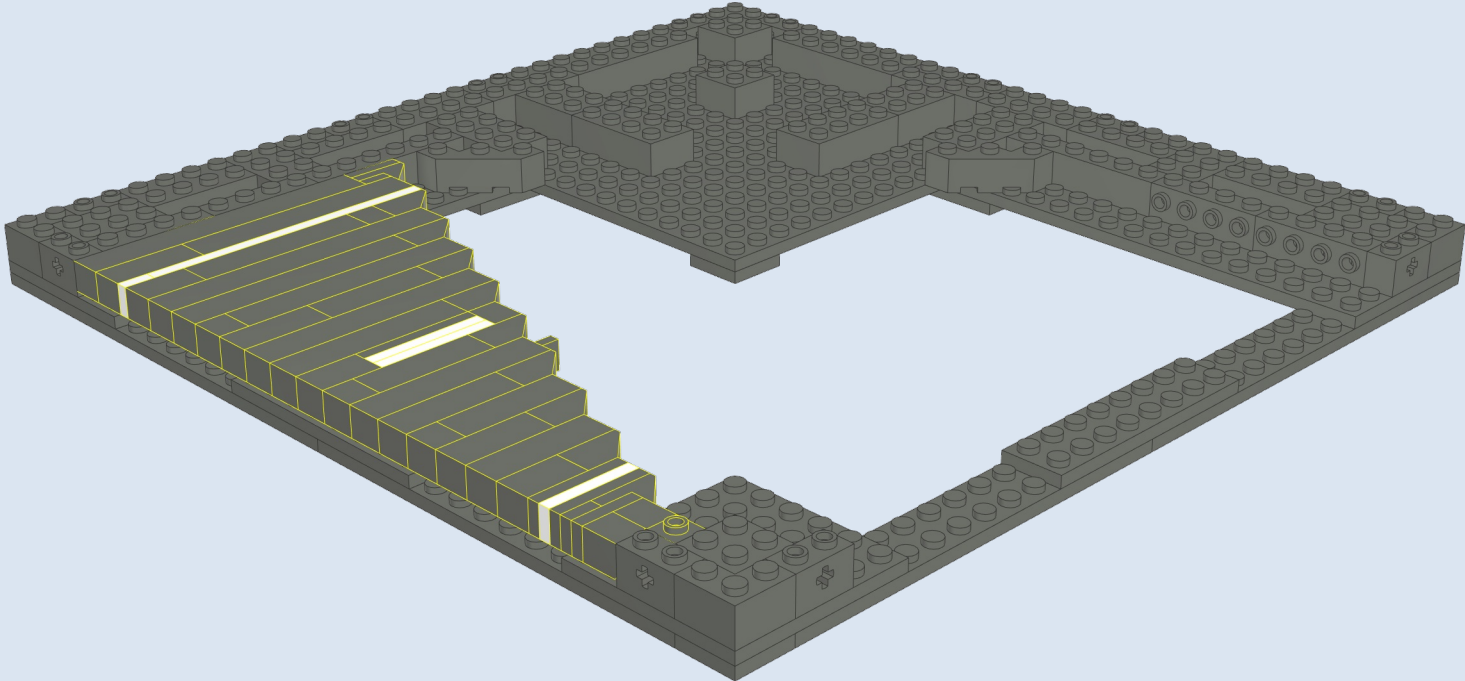



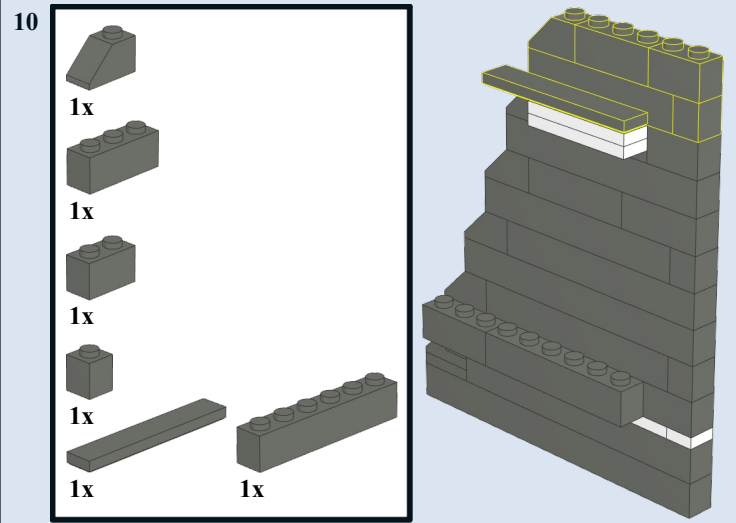
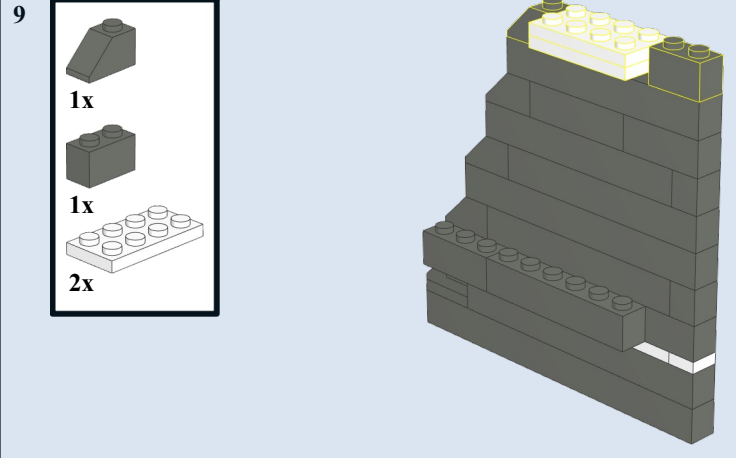
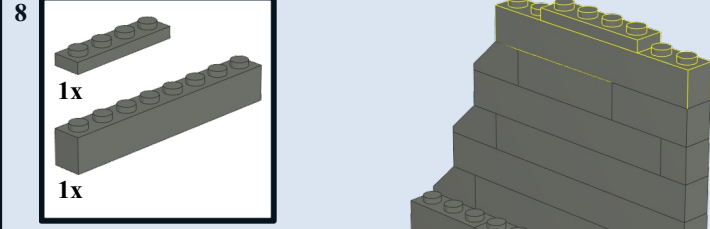
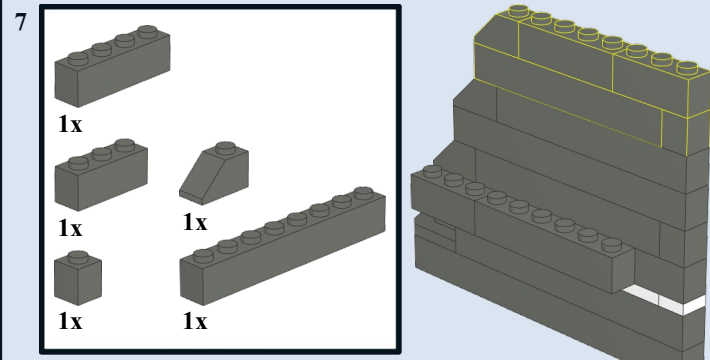
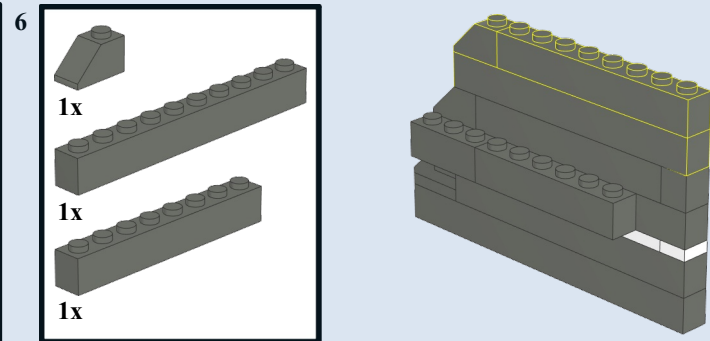
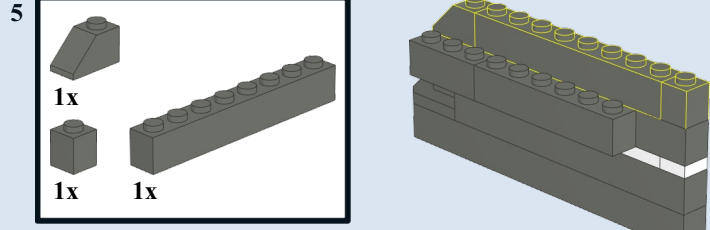
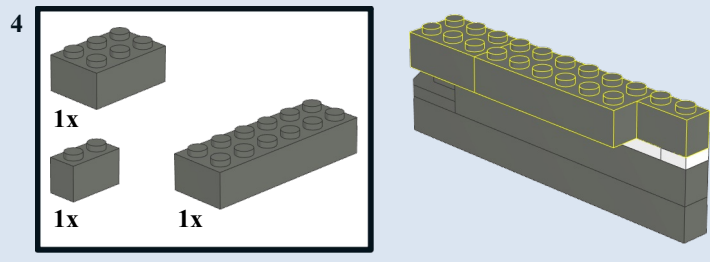
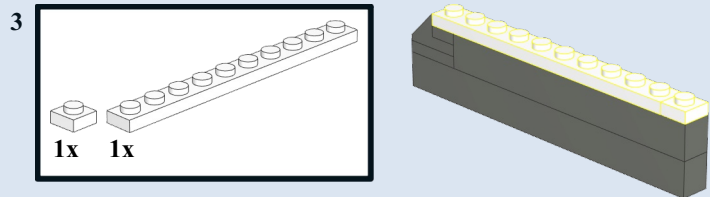
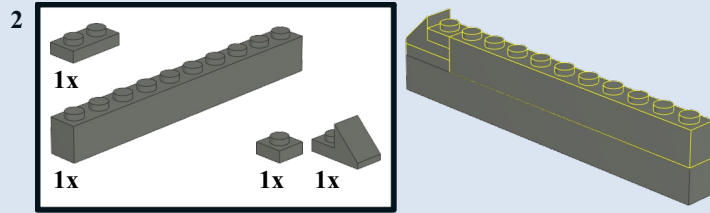
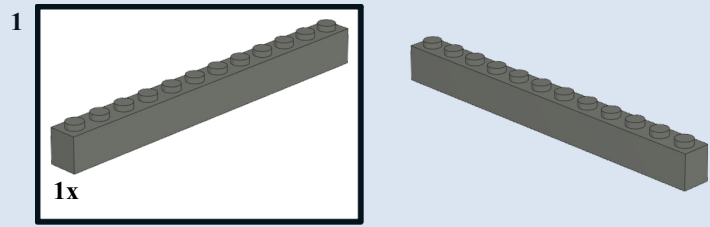

11

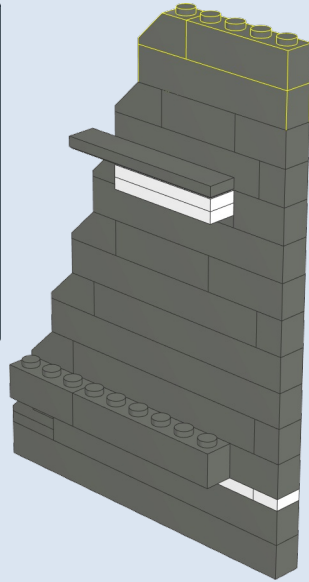
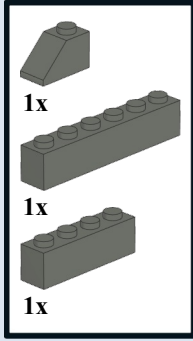

13

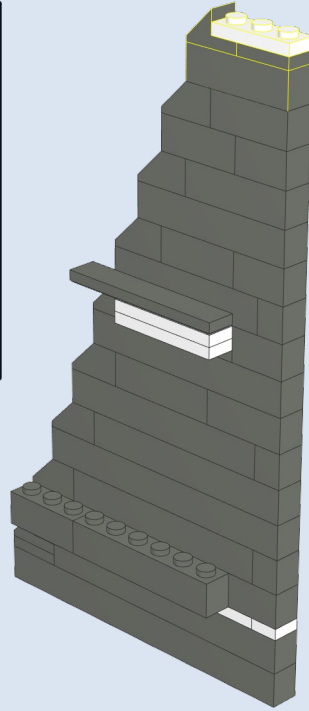
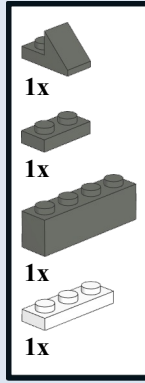

15

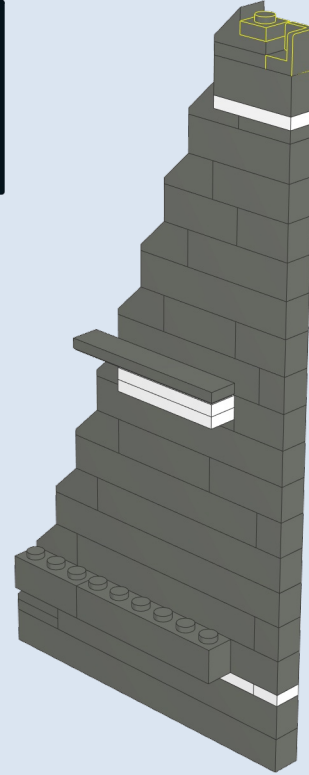
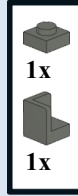

16

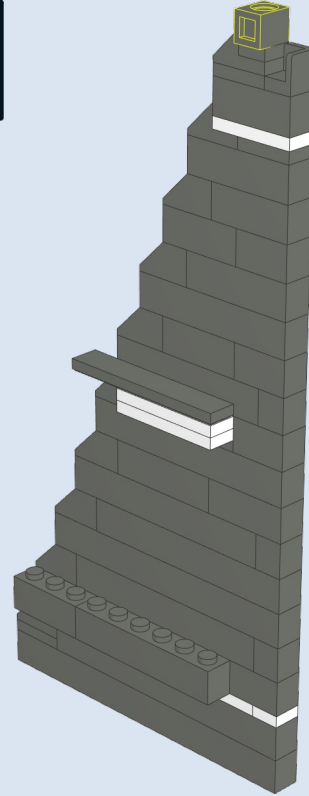
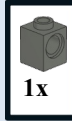

12

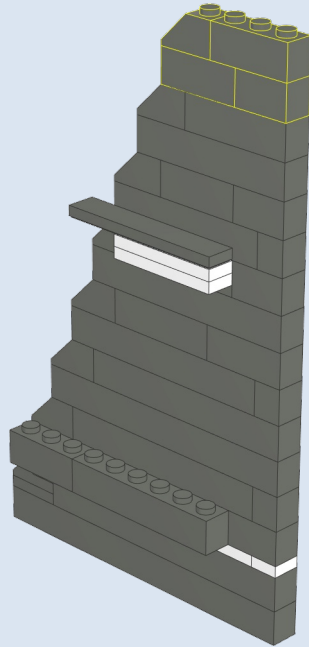
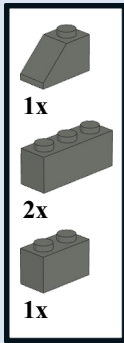

14

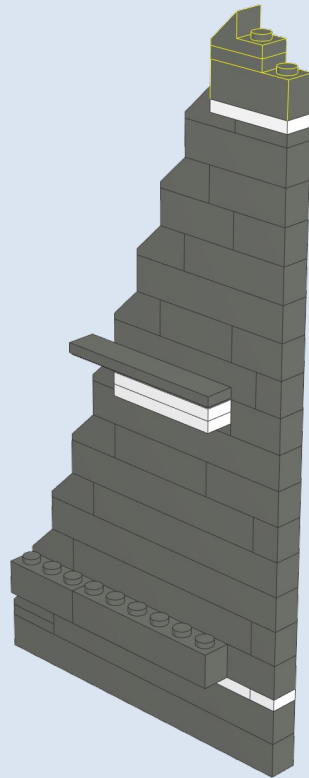
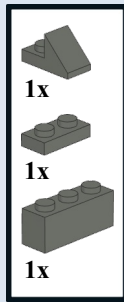

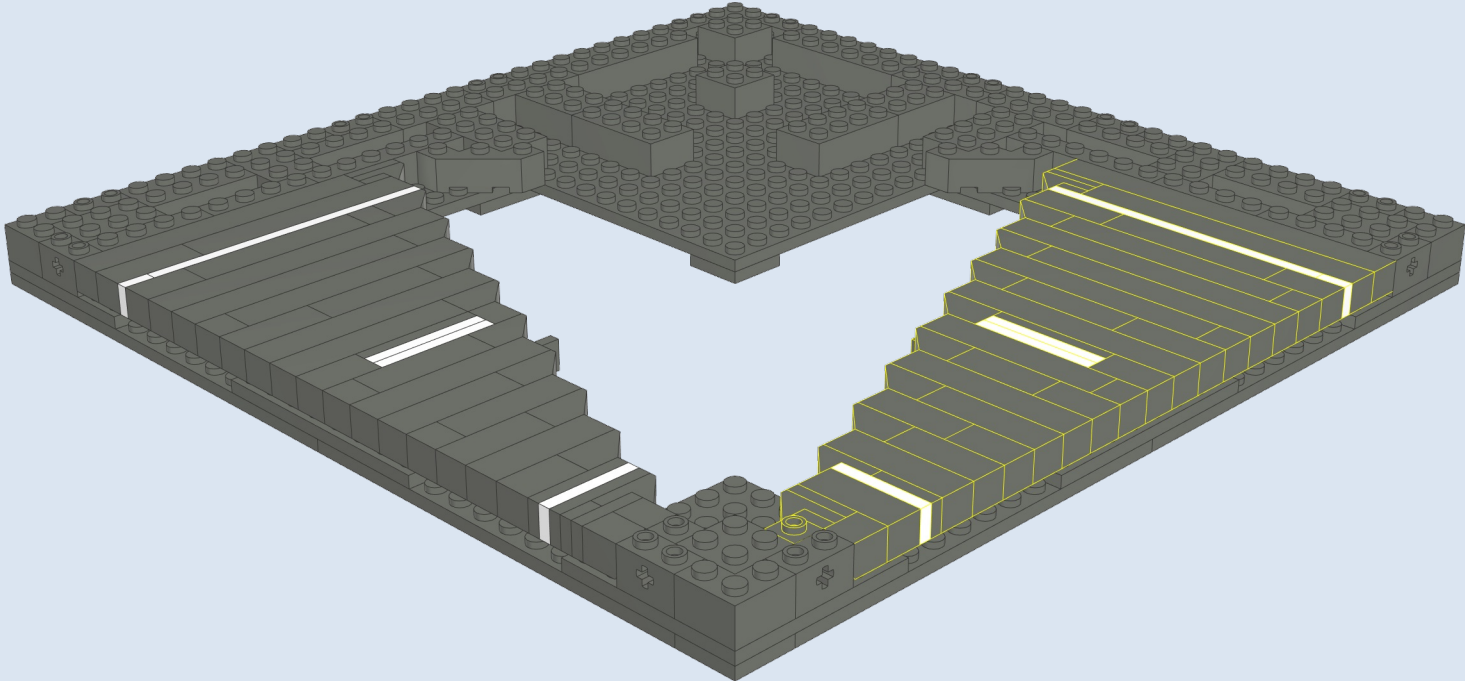

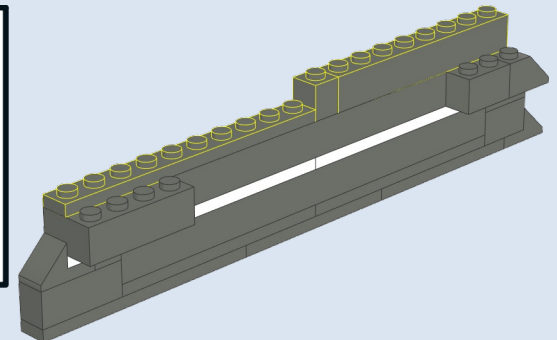
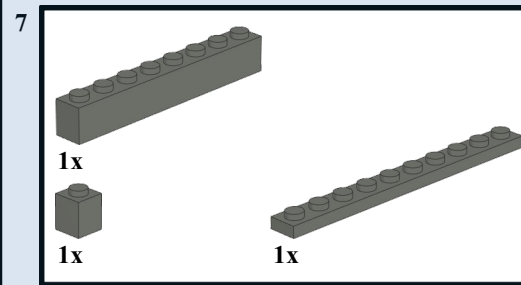
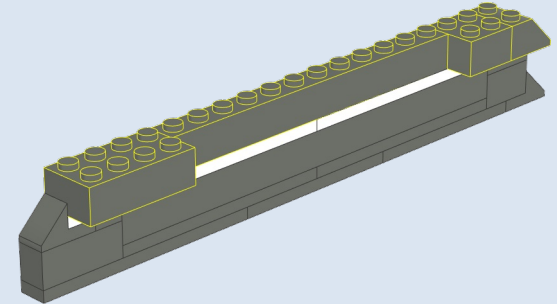
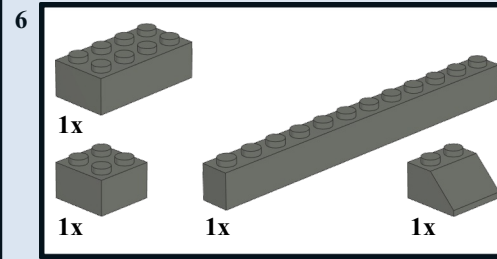
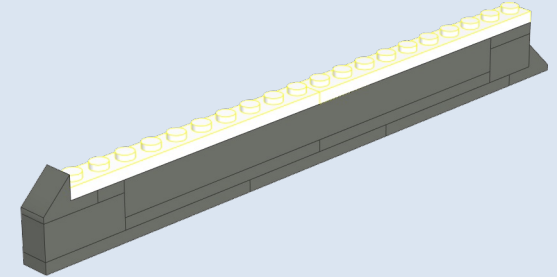
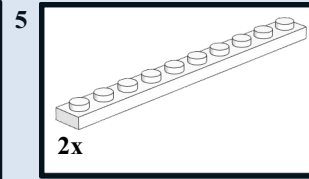
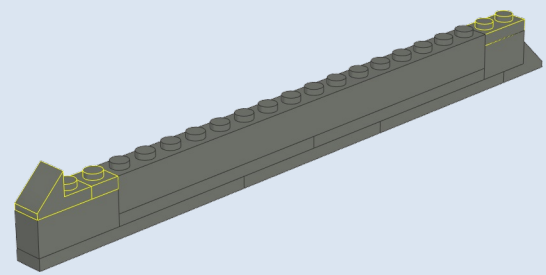
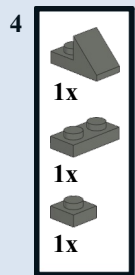
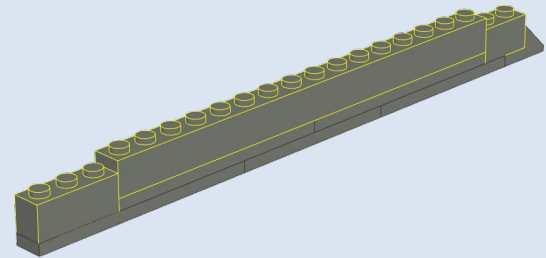
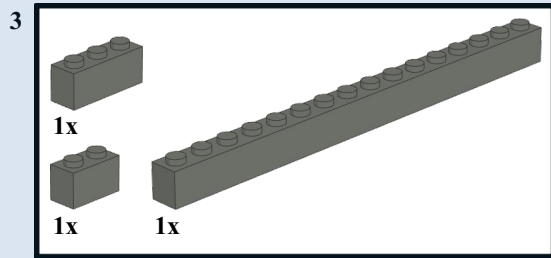
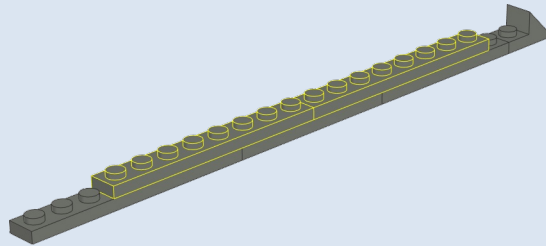
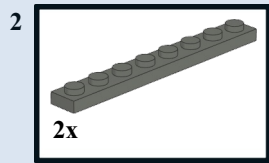
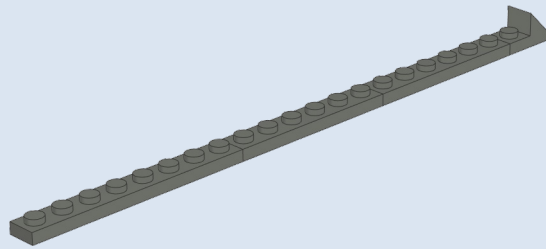
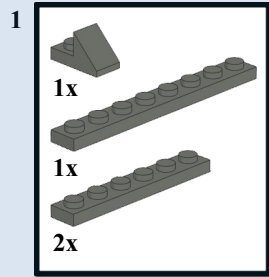

8

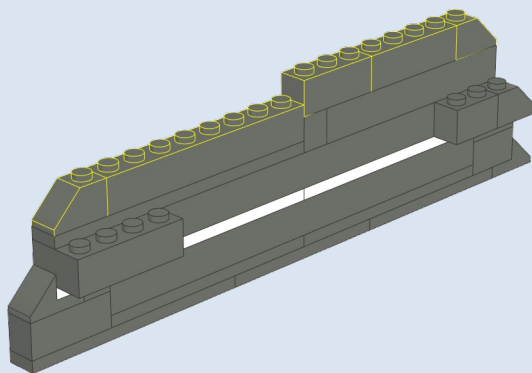
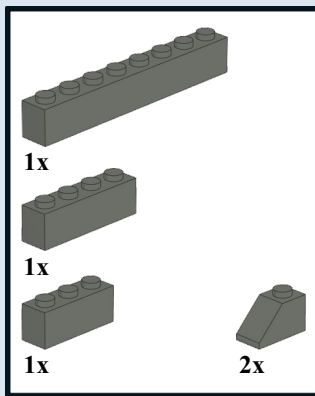

11

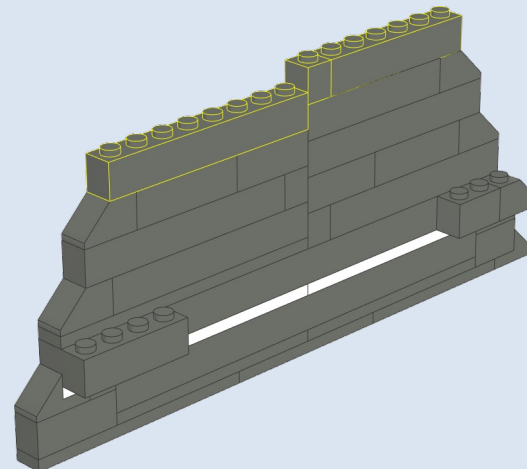
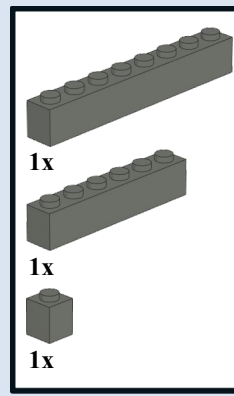

9

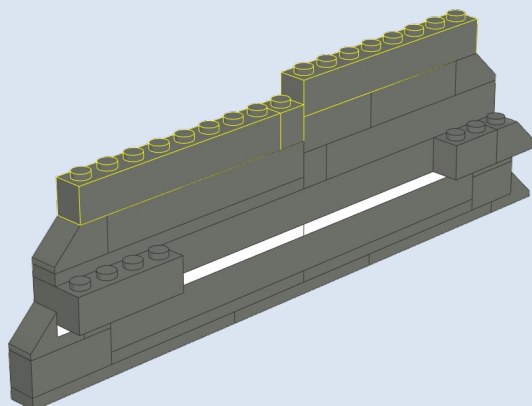
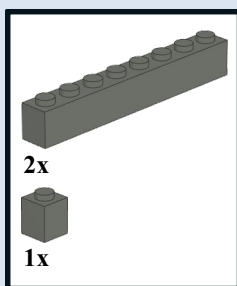

12

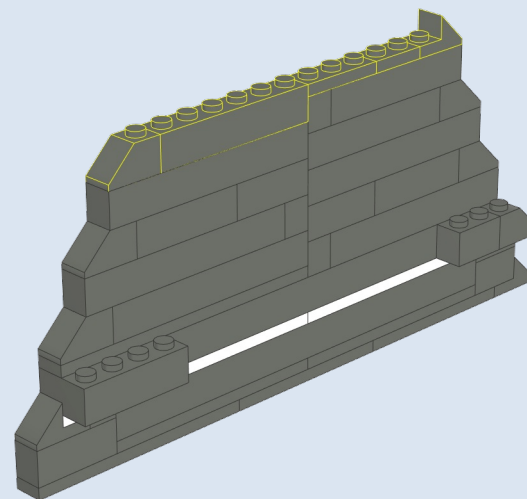
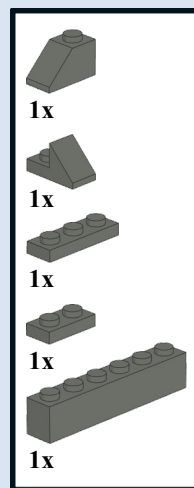

10

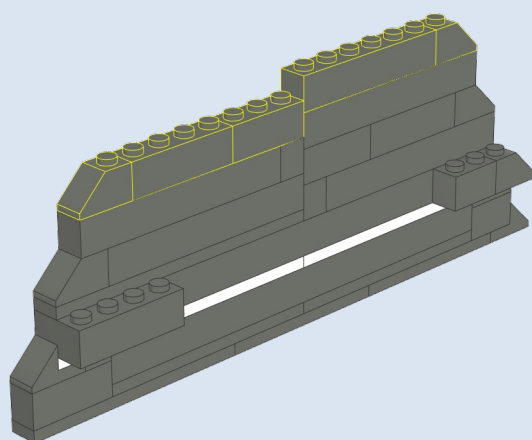
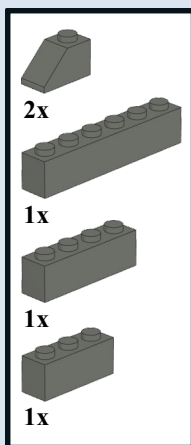

13

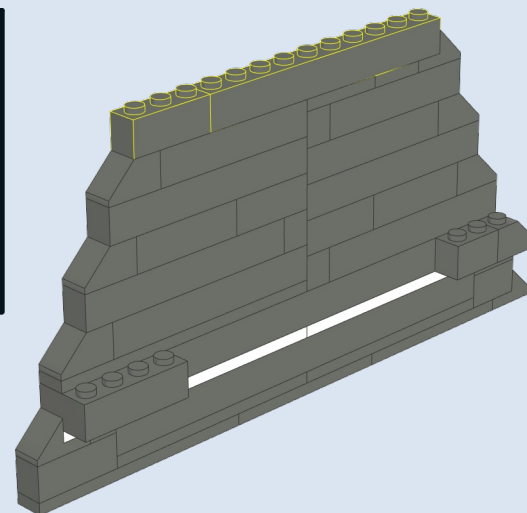
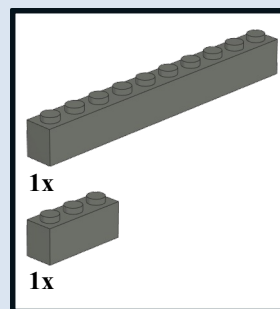

14

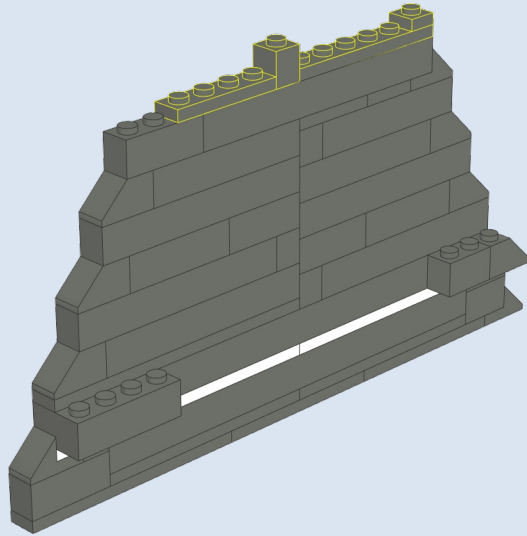
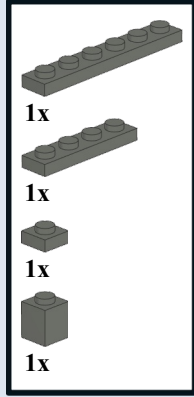

16

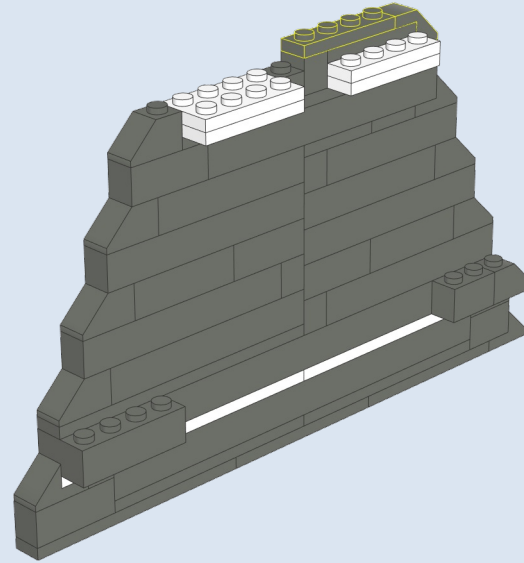
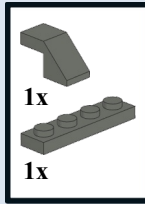

18

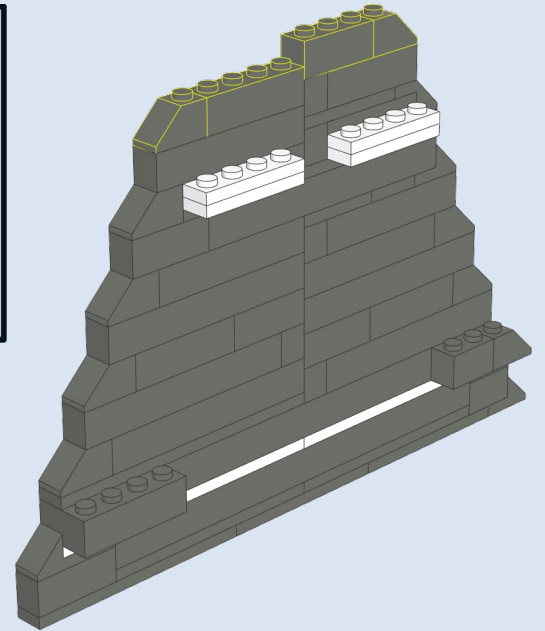
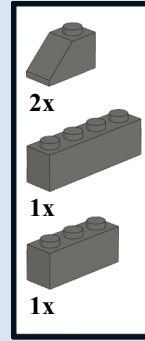

15

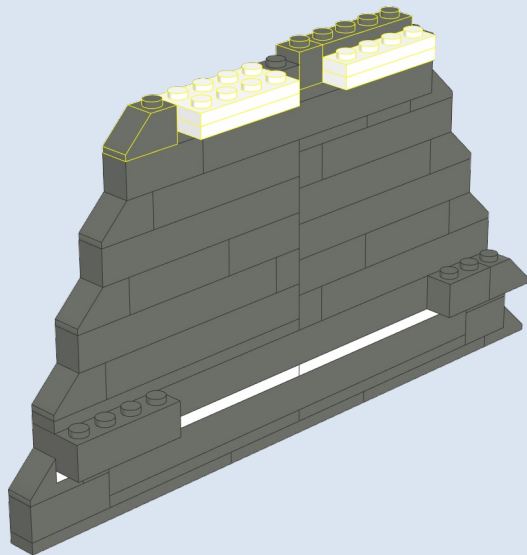
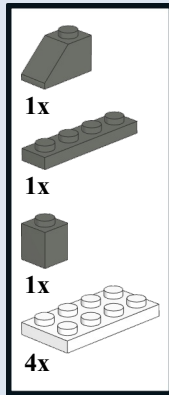

17

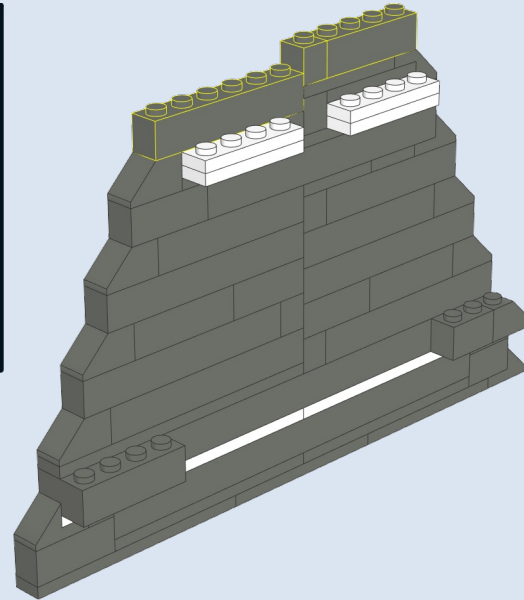
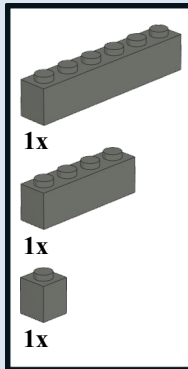

19

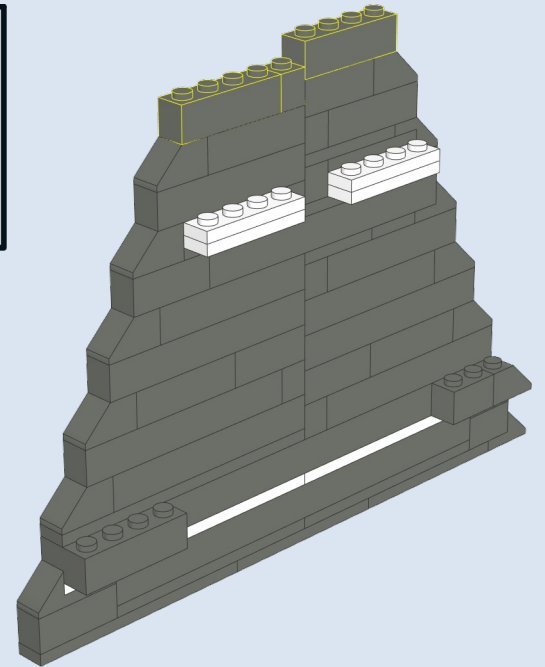
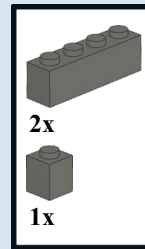

20

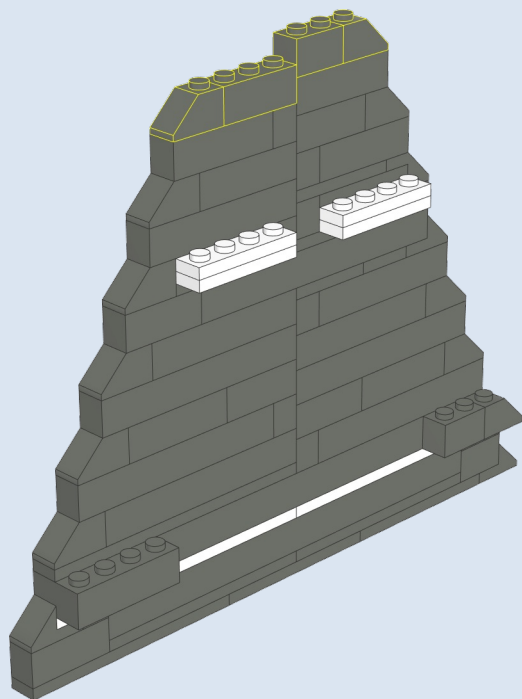
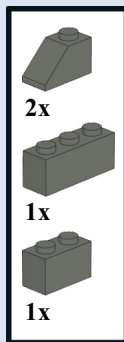

22

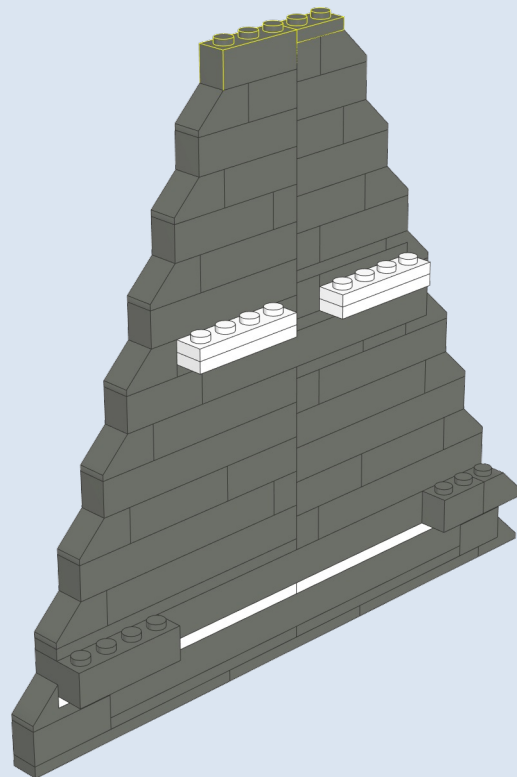
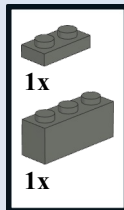

21

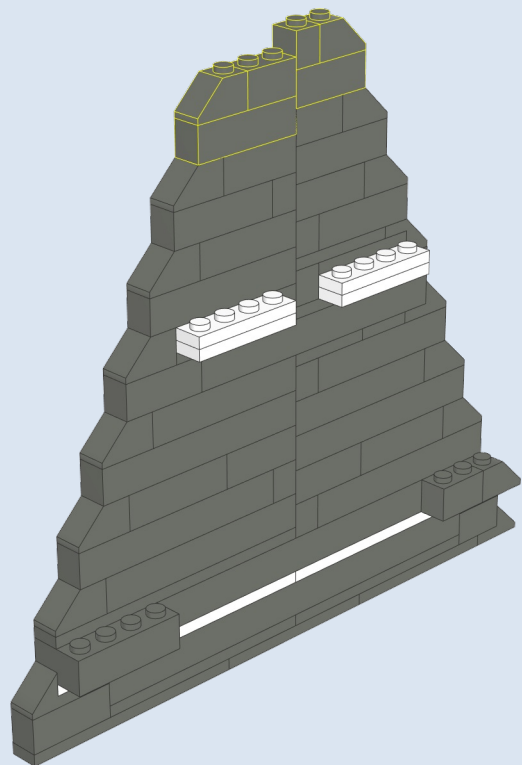
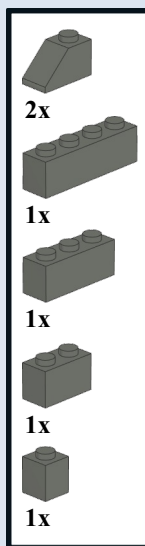

23

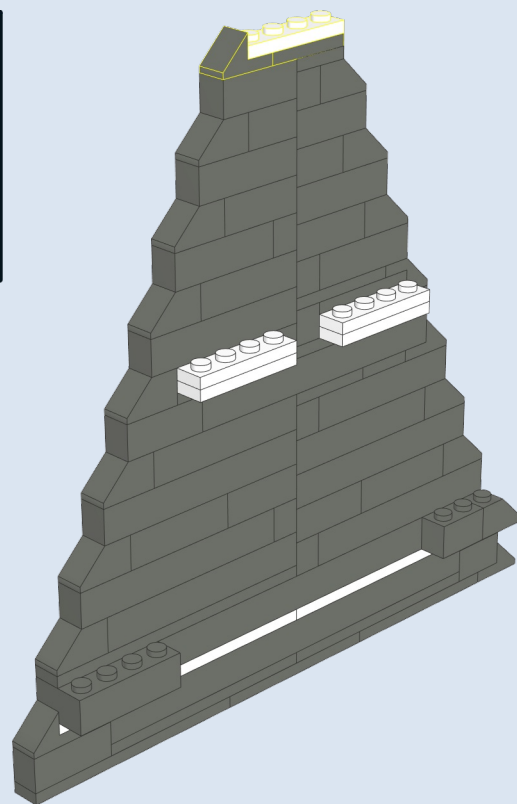
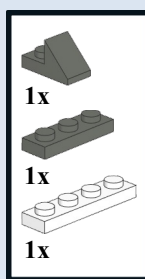

24

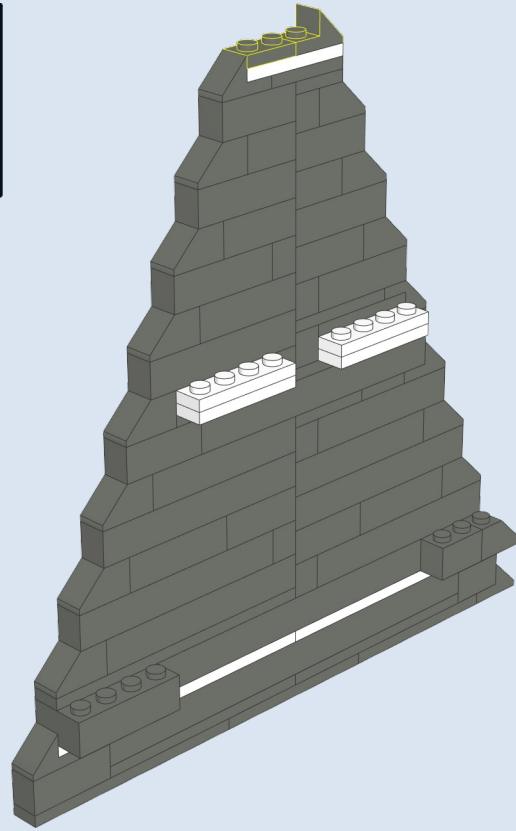
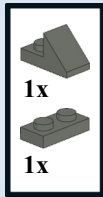

25

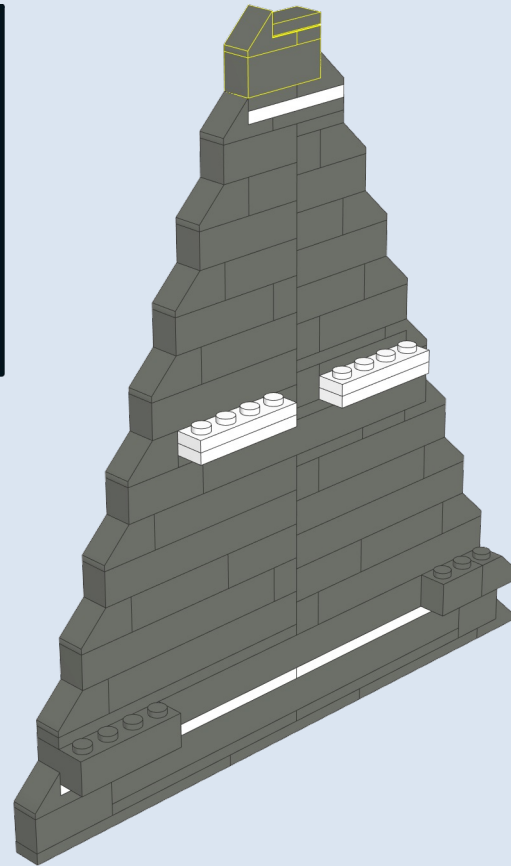
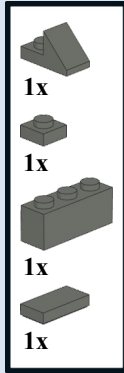



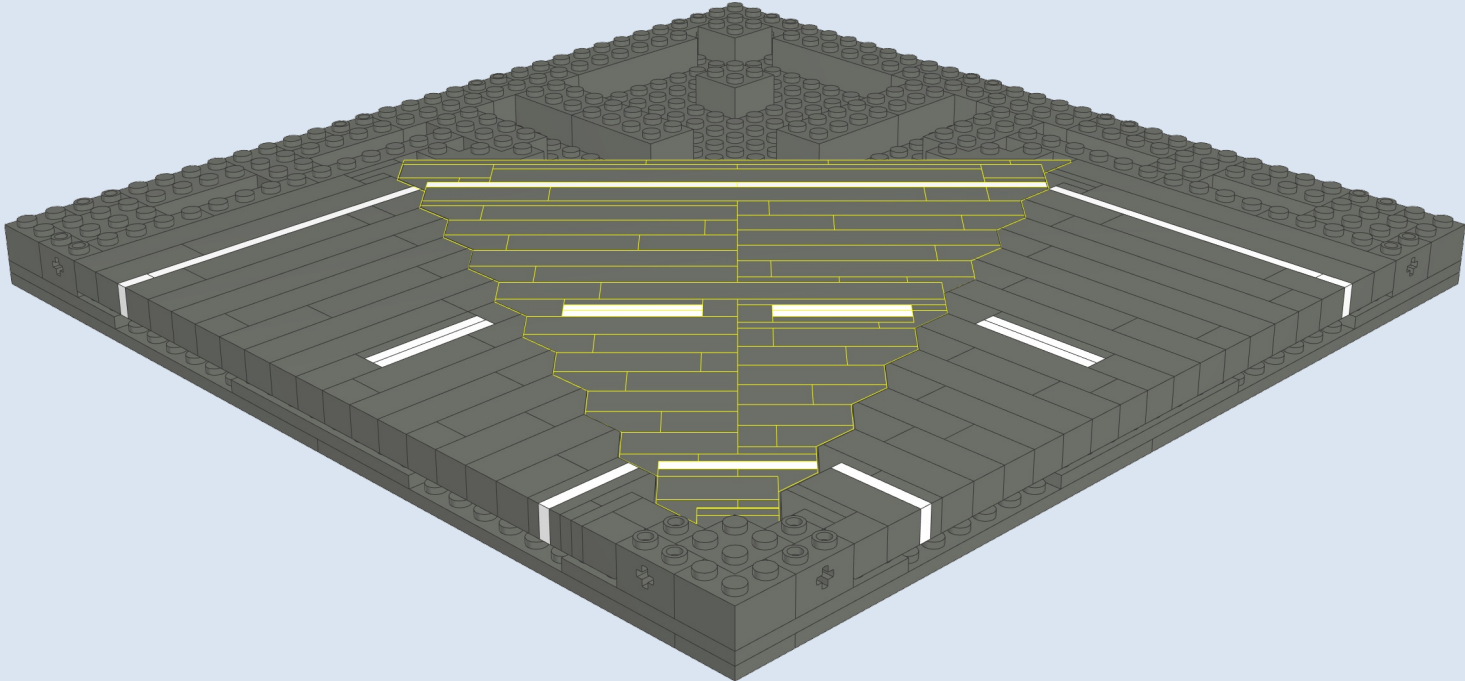

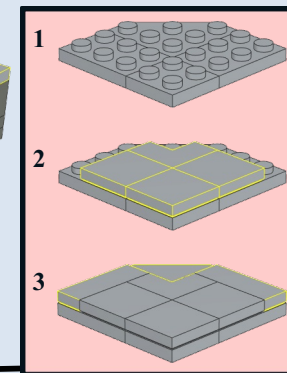
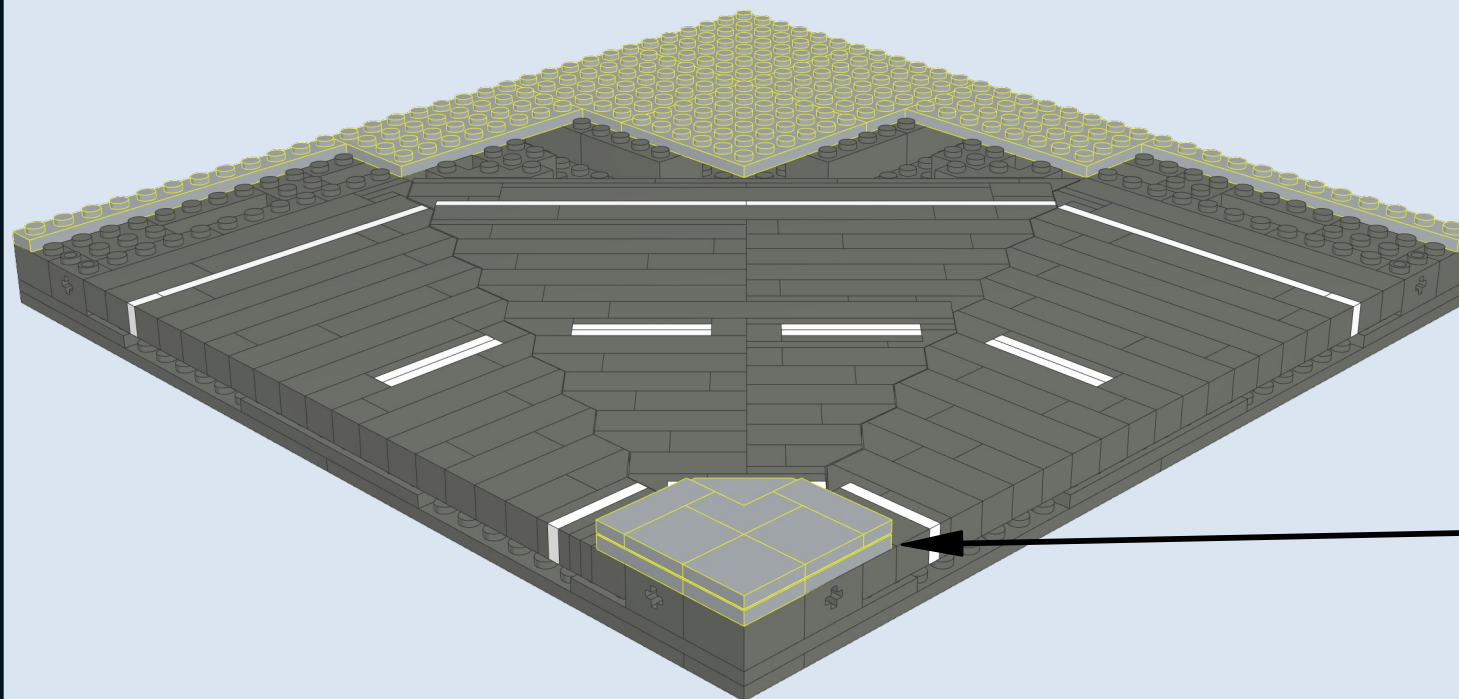
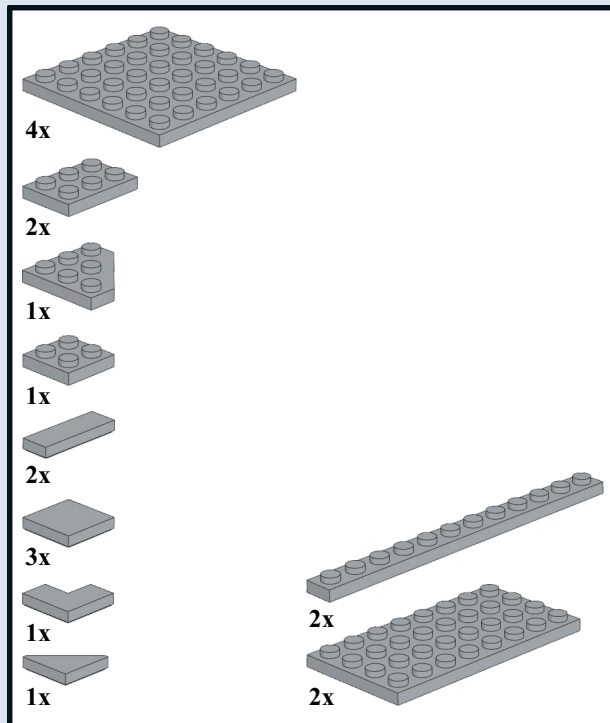

13

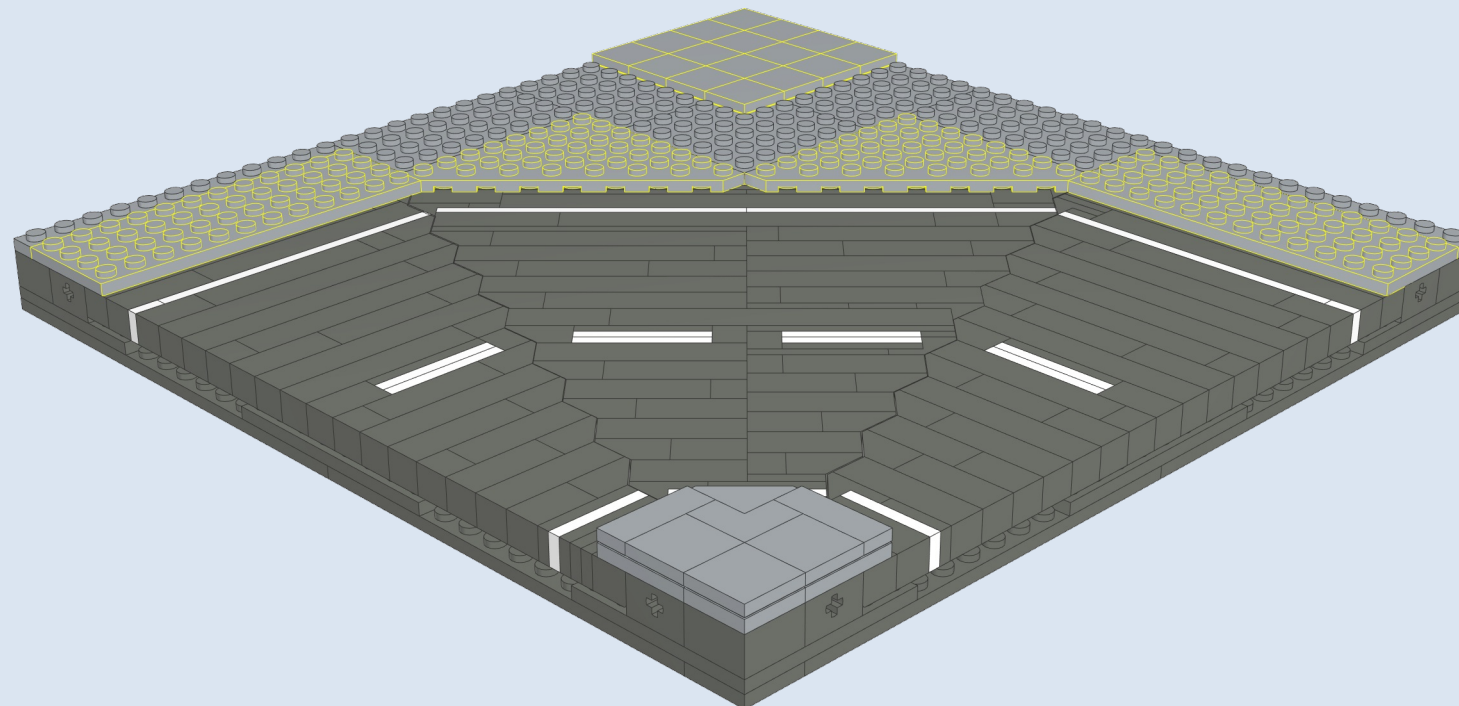
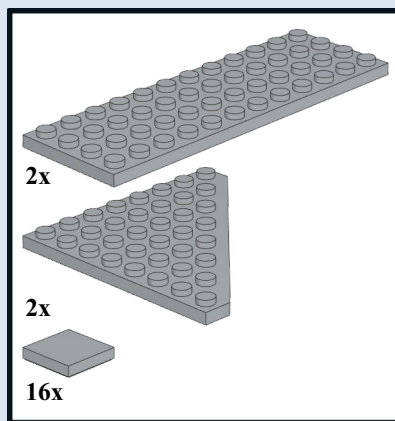

14



15   
20x

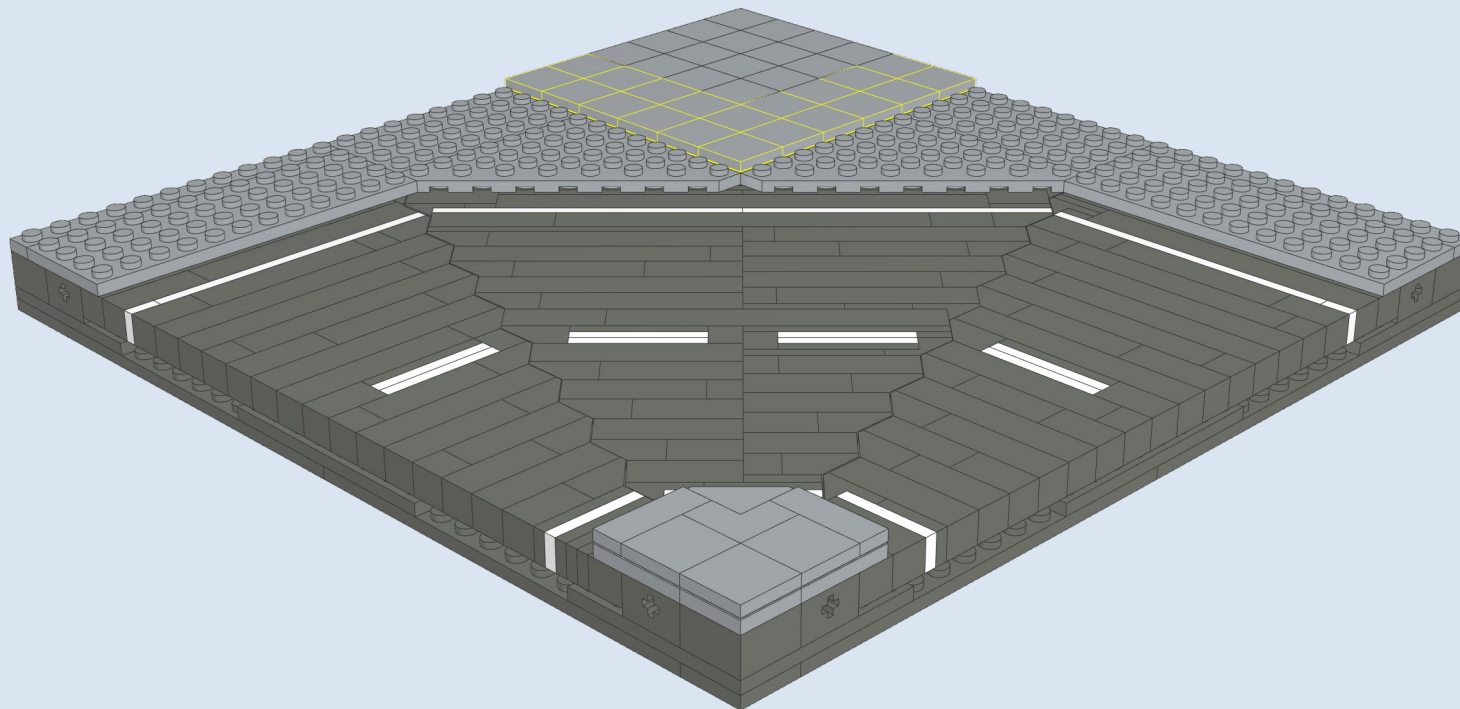

16   
24x

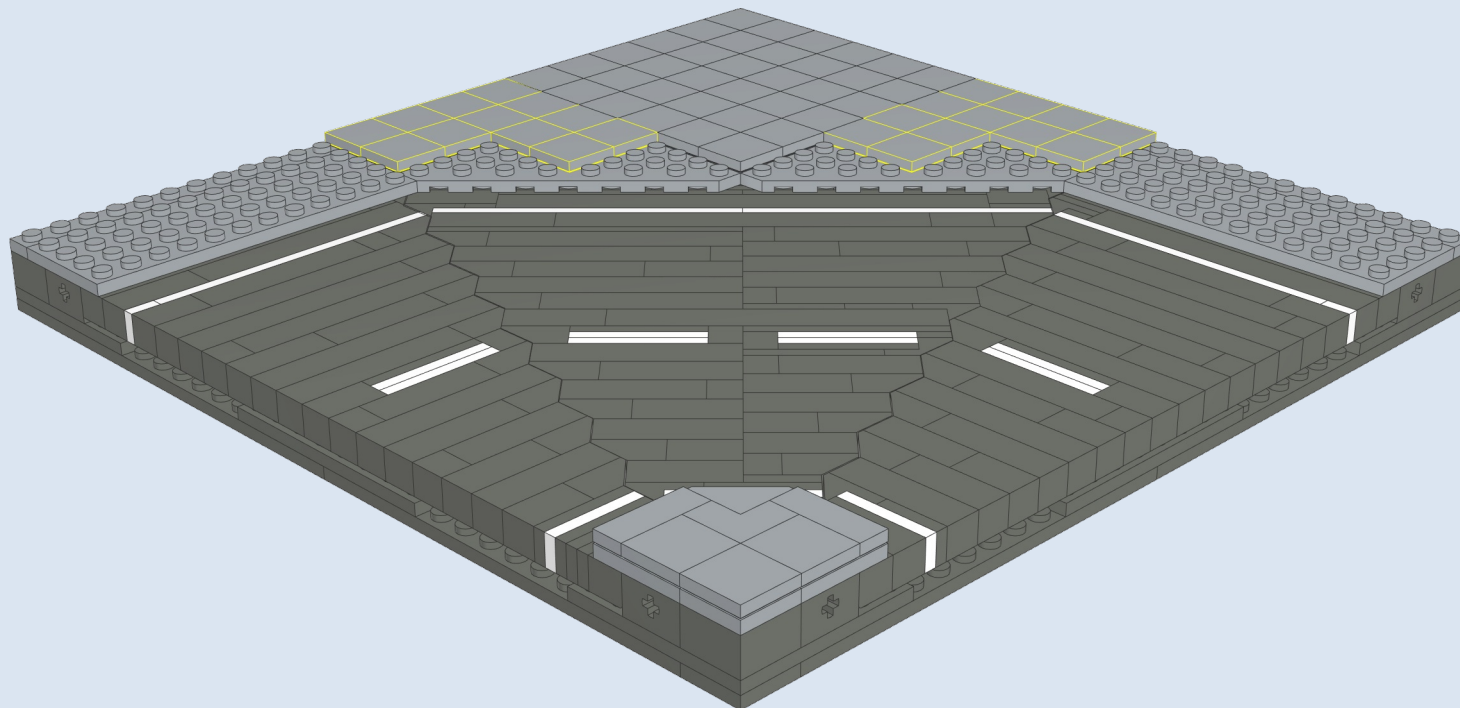

17

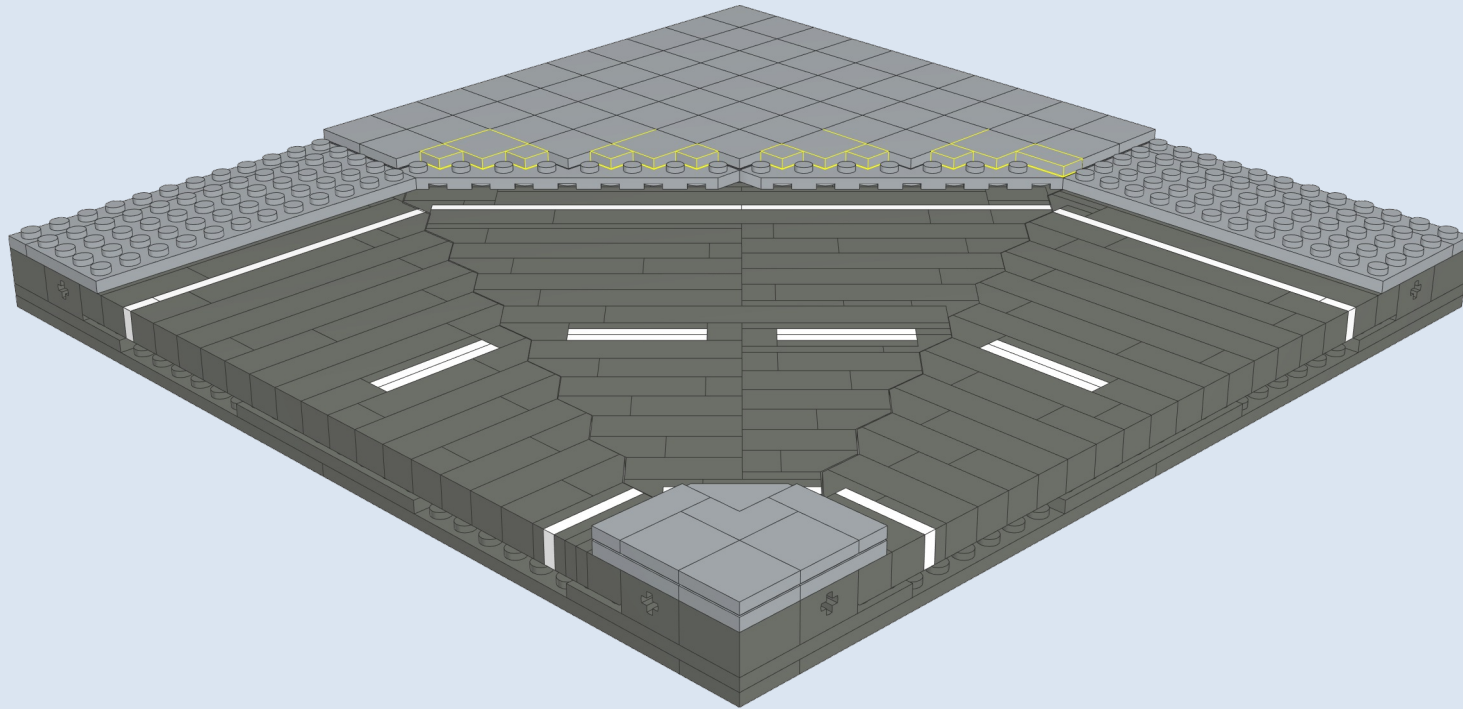
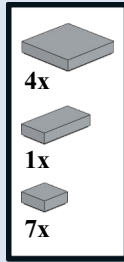

18

