

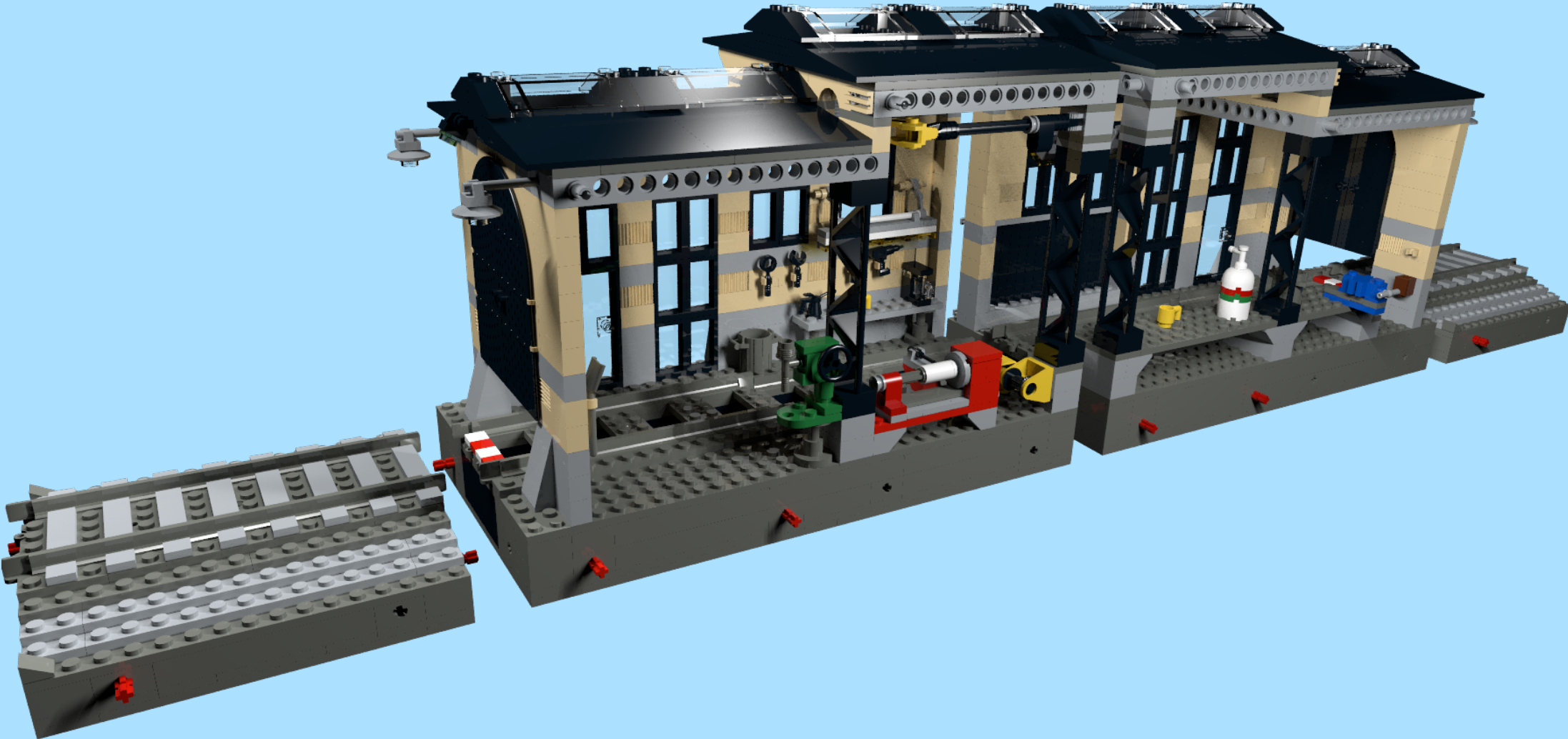

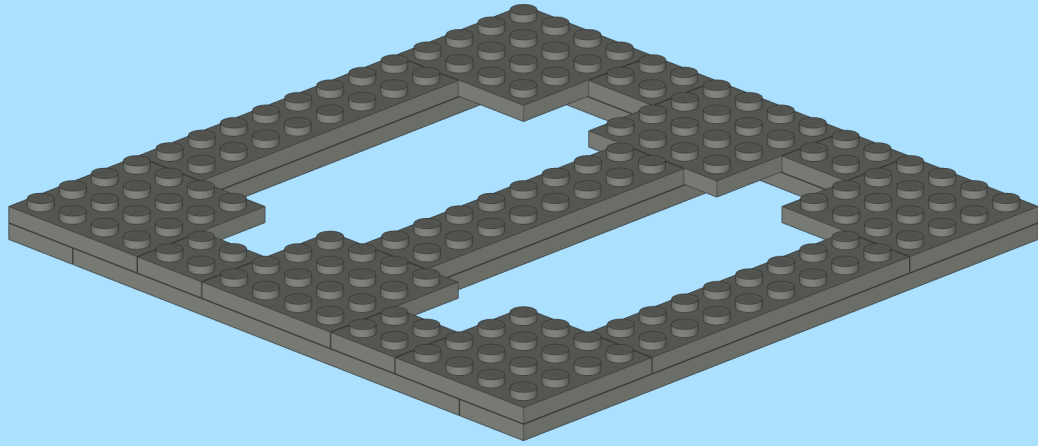

10027 Train Engine Shed MOD

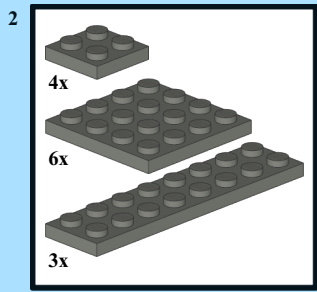

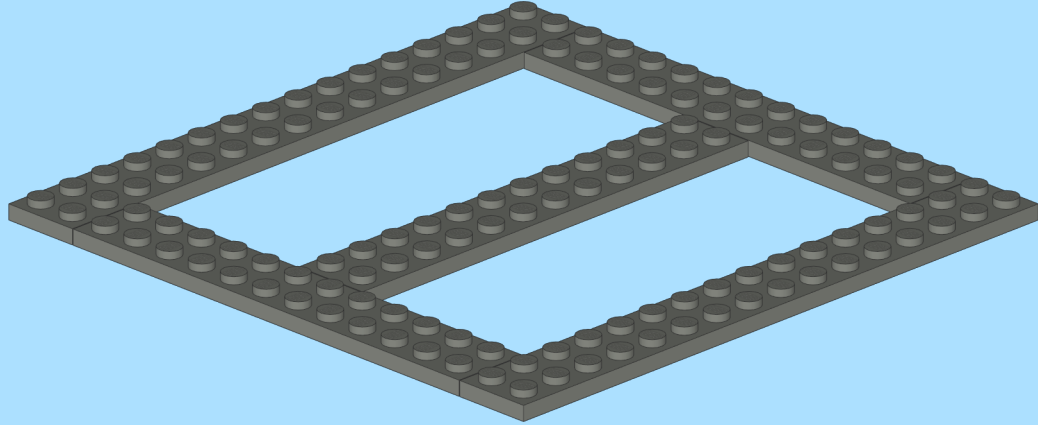
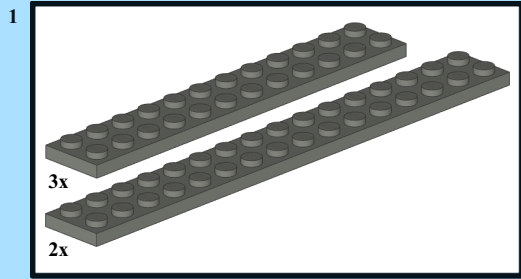

Original Design by LEGO
MOD By Dennis Tomsen
With input from Knud Ahrnell Albrechtsen

INSTRUCTION BY
KNUD ALBRECHTSEN
www.snakebyte.dk/lego

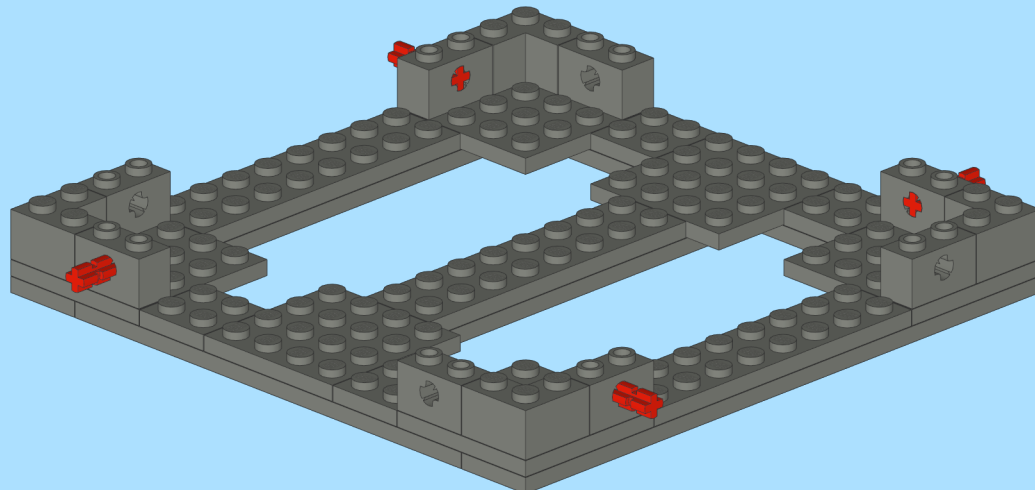

- 3
- 4x 
 - 8x 
 - 4x 



- 4
- 5x 
 - 4x 

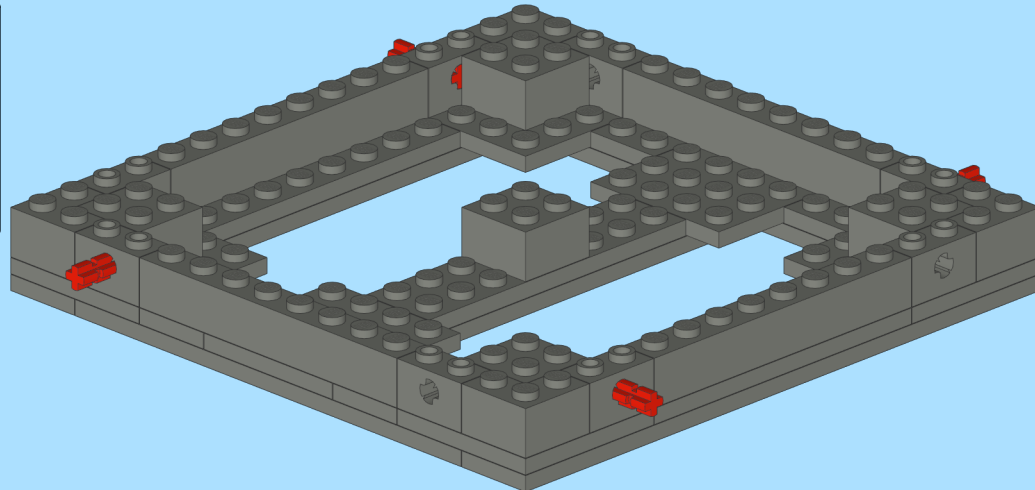

5

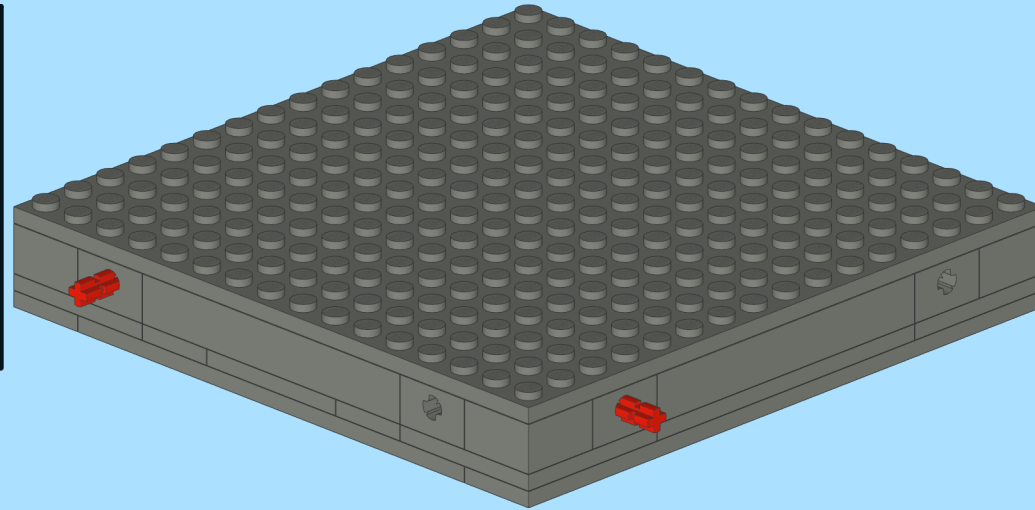
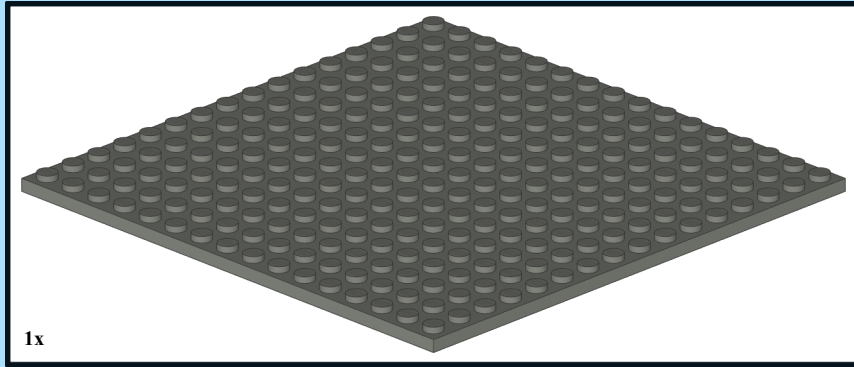

6

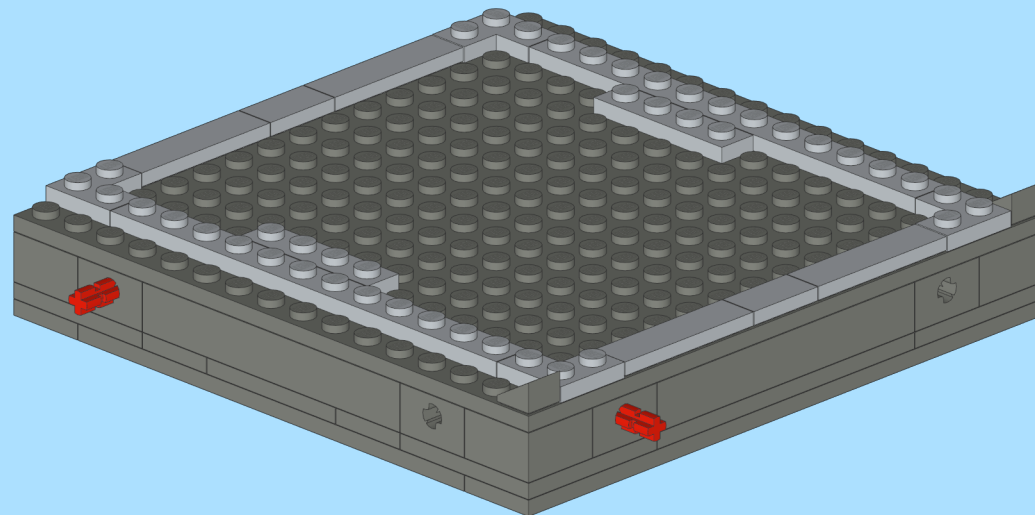
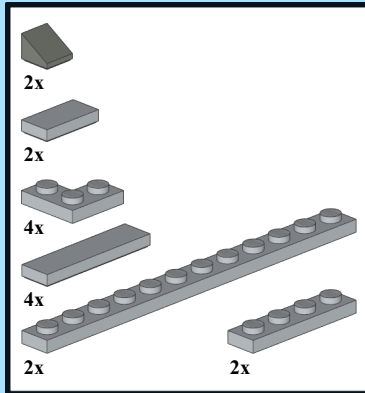

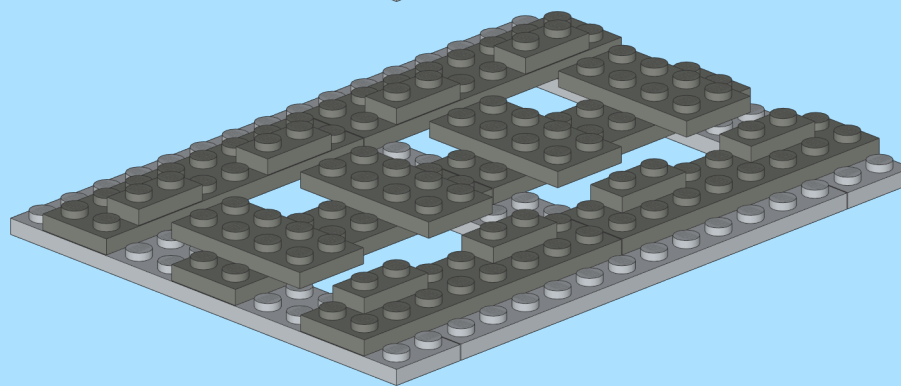
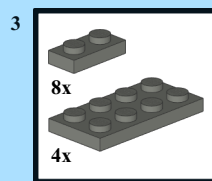
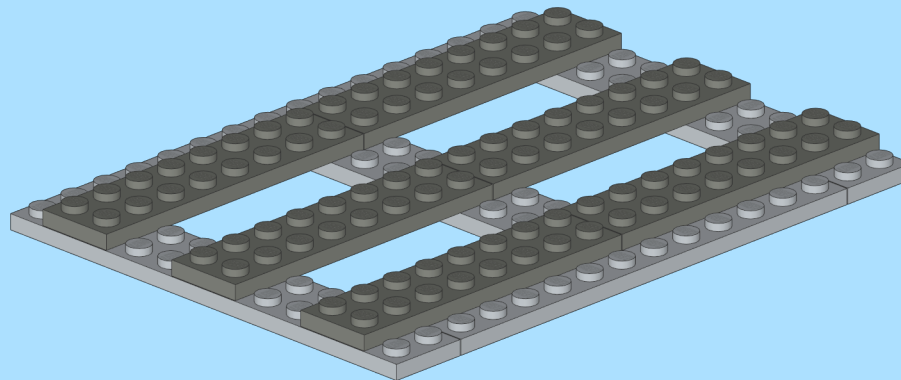
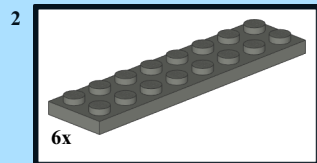
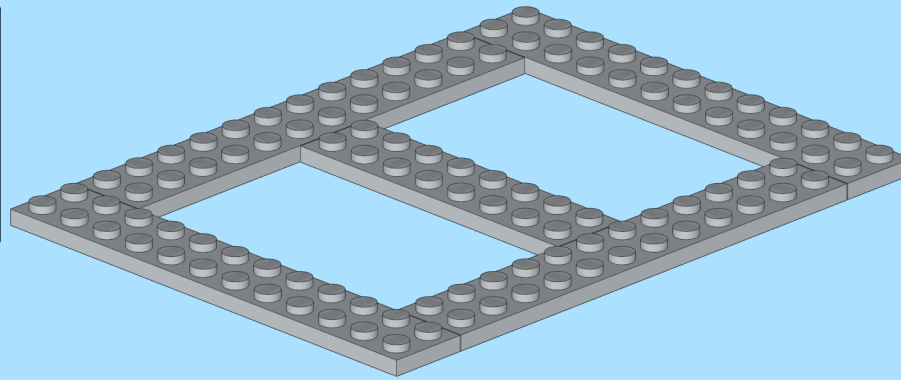
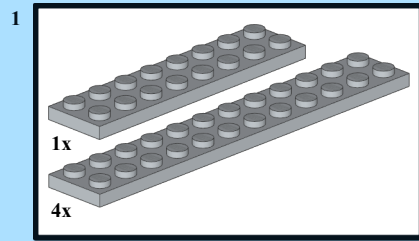

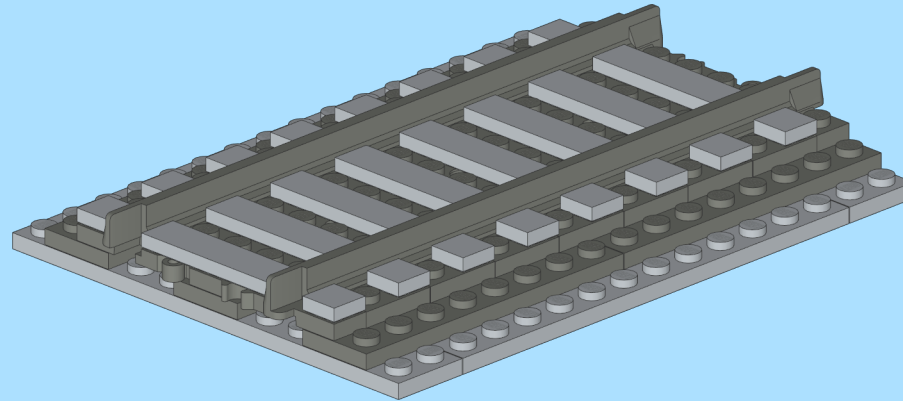
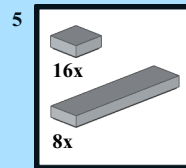
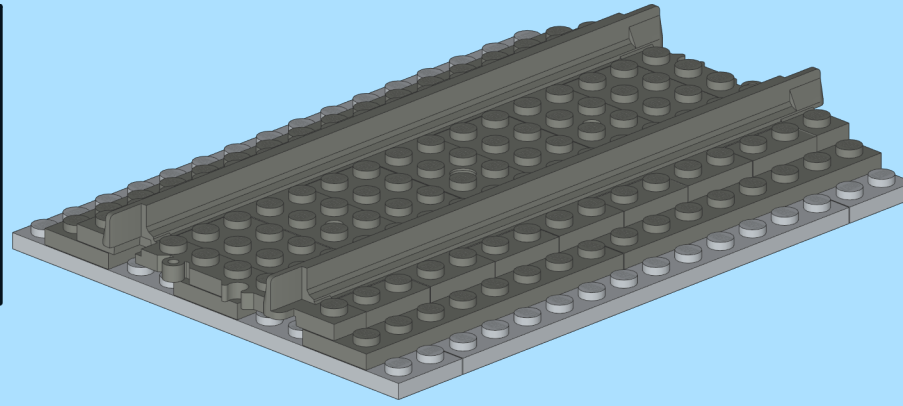
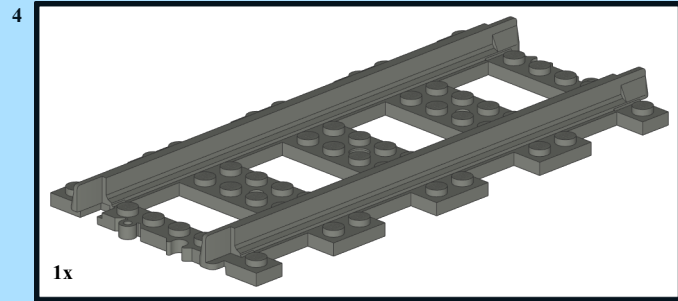

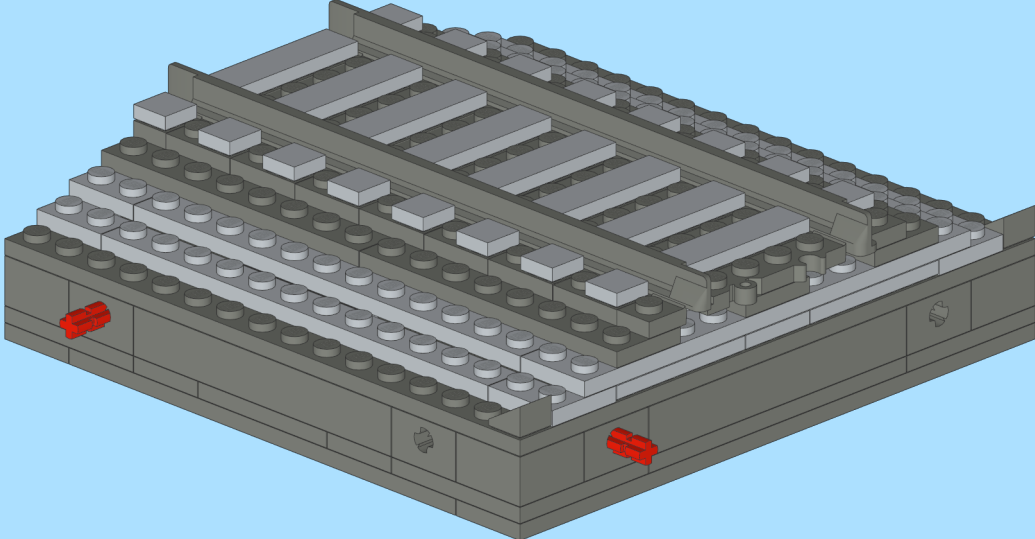

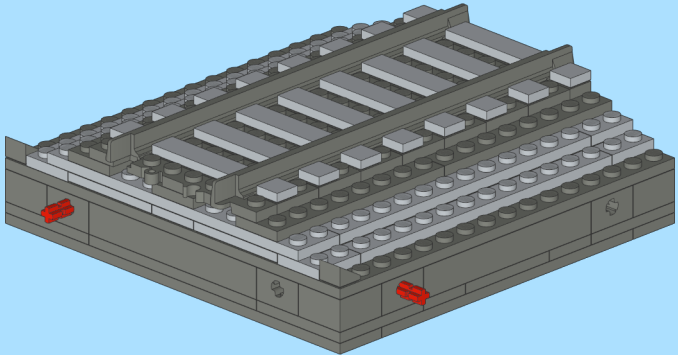

1

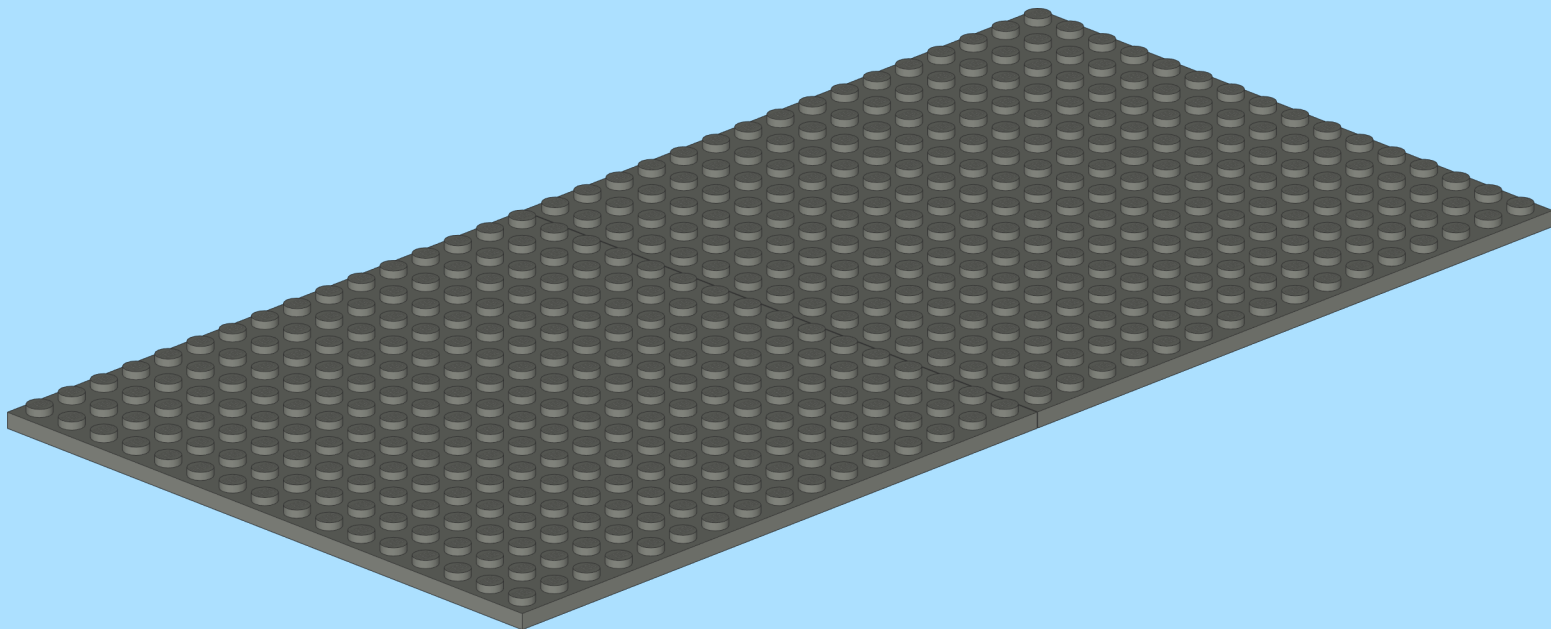
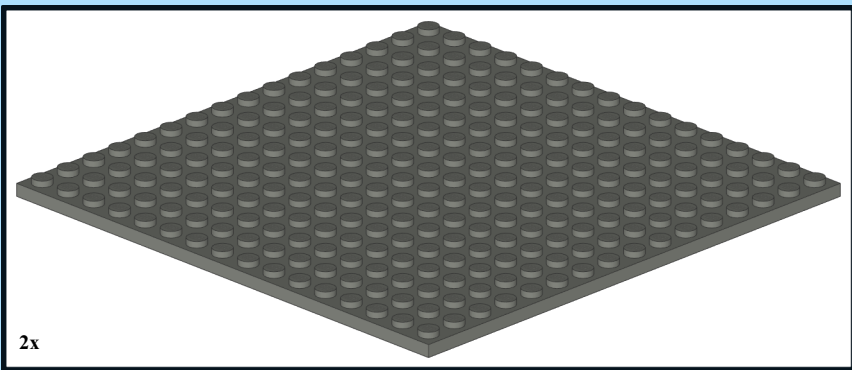

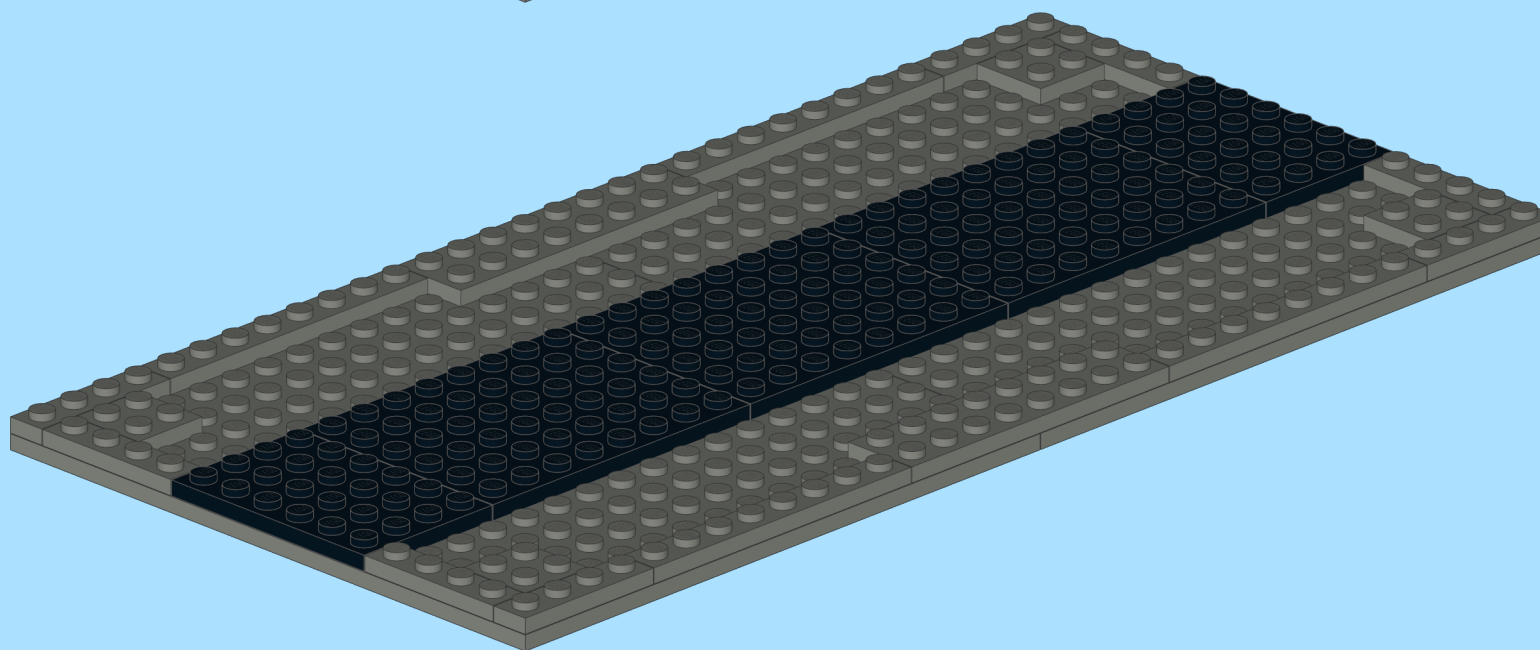
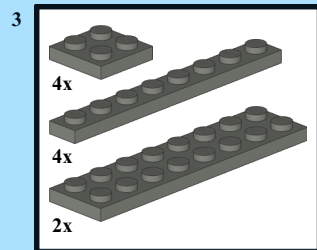
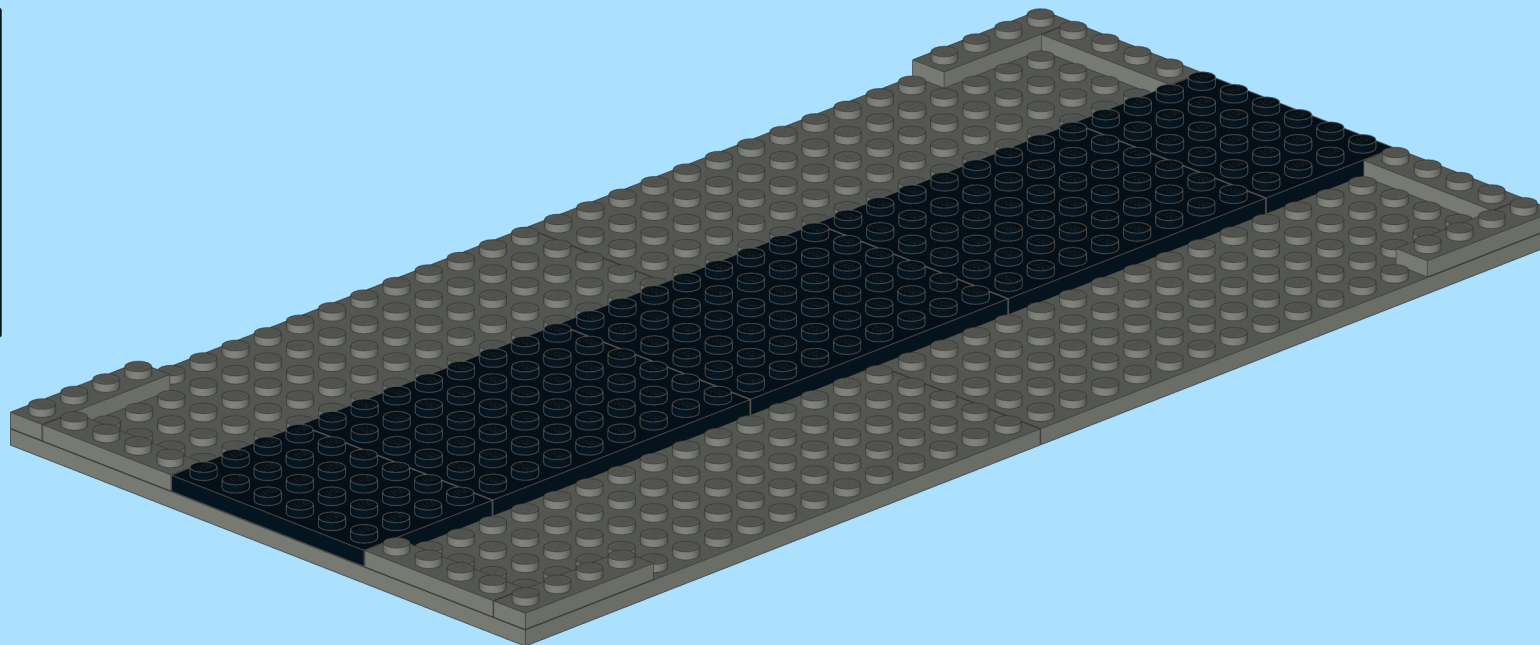
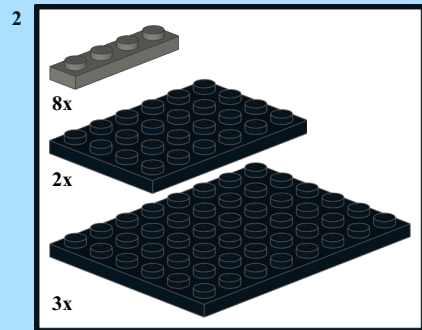

4

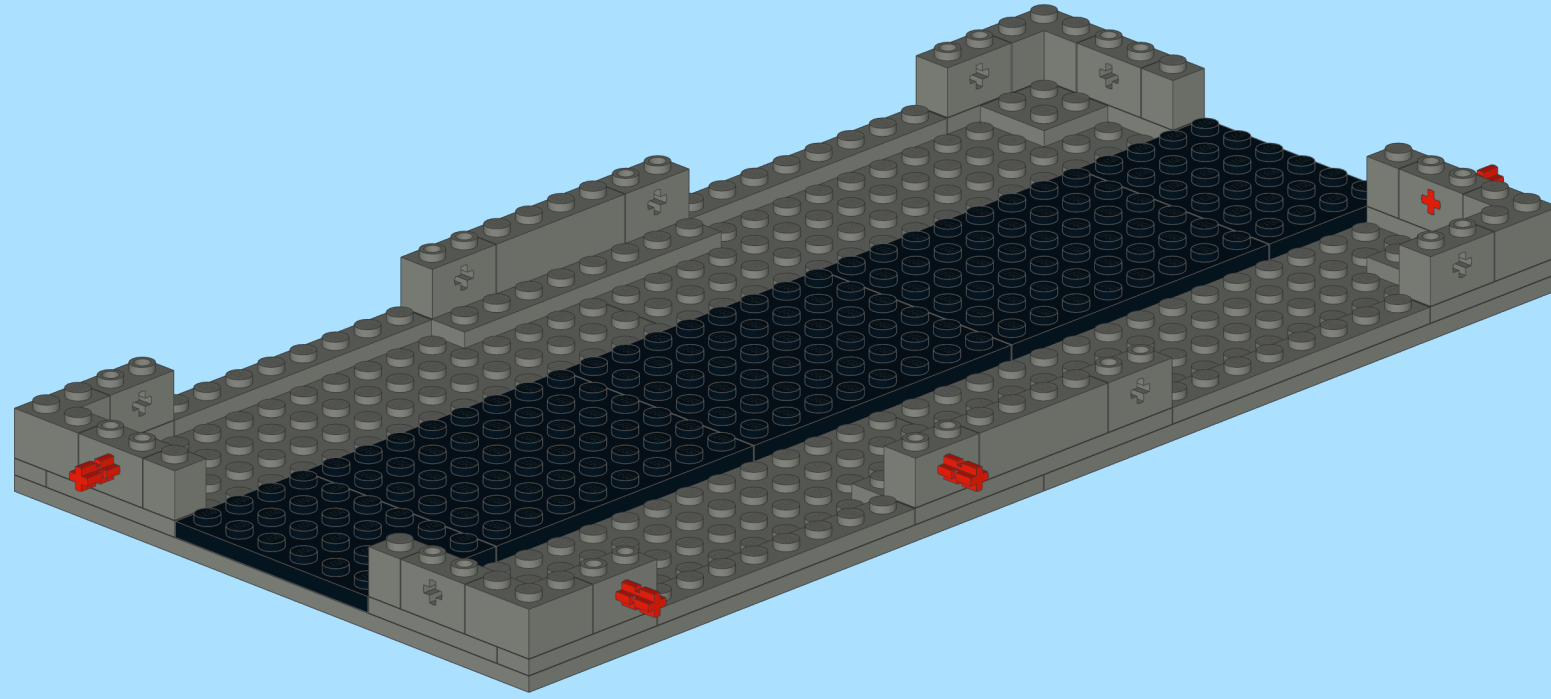
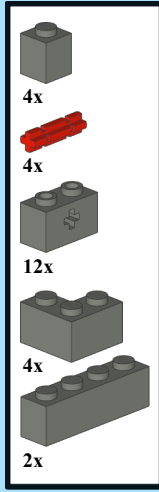

5

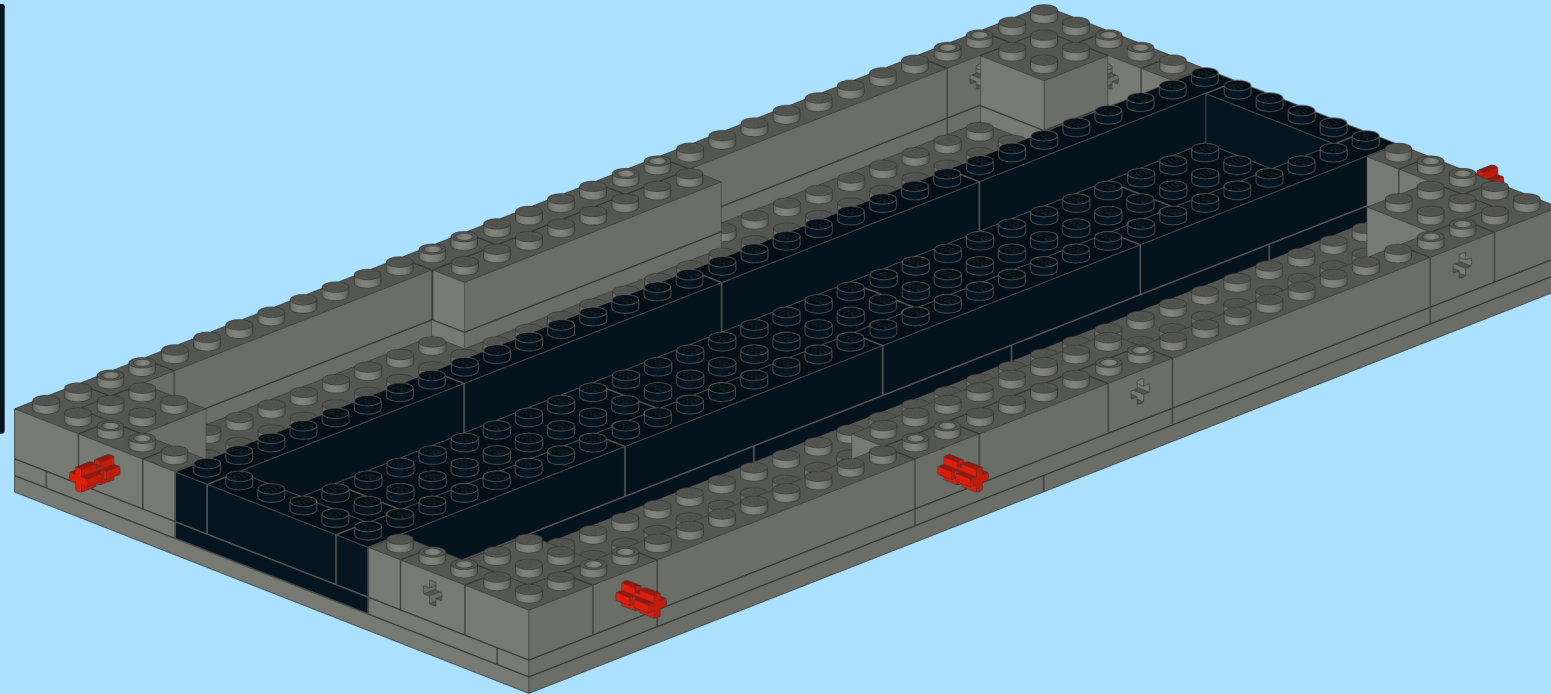
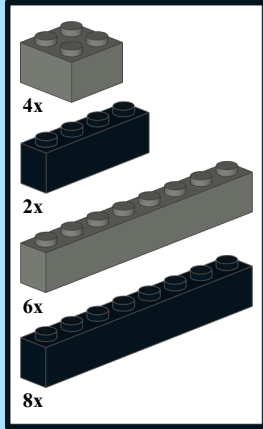

6

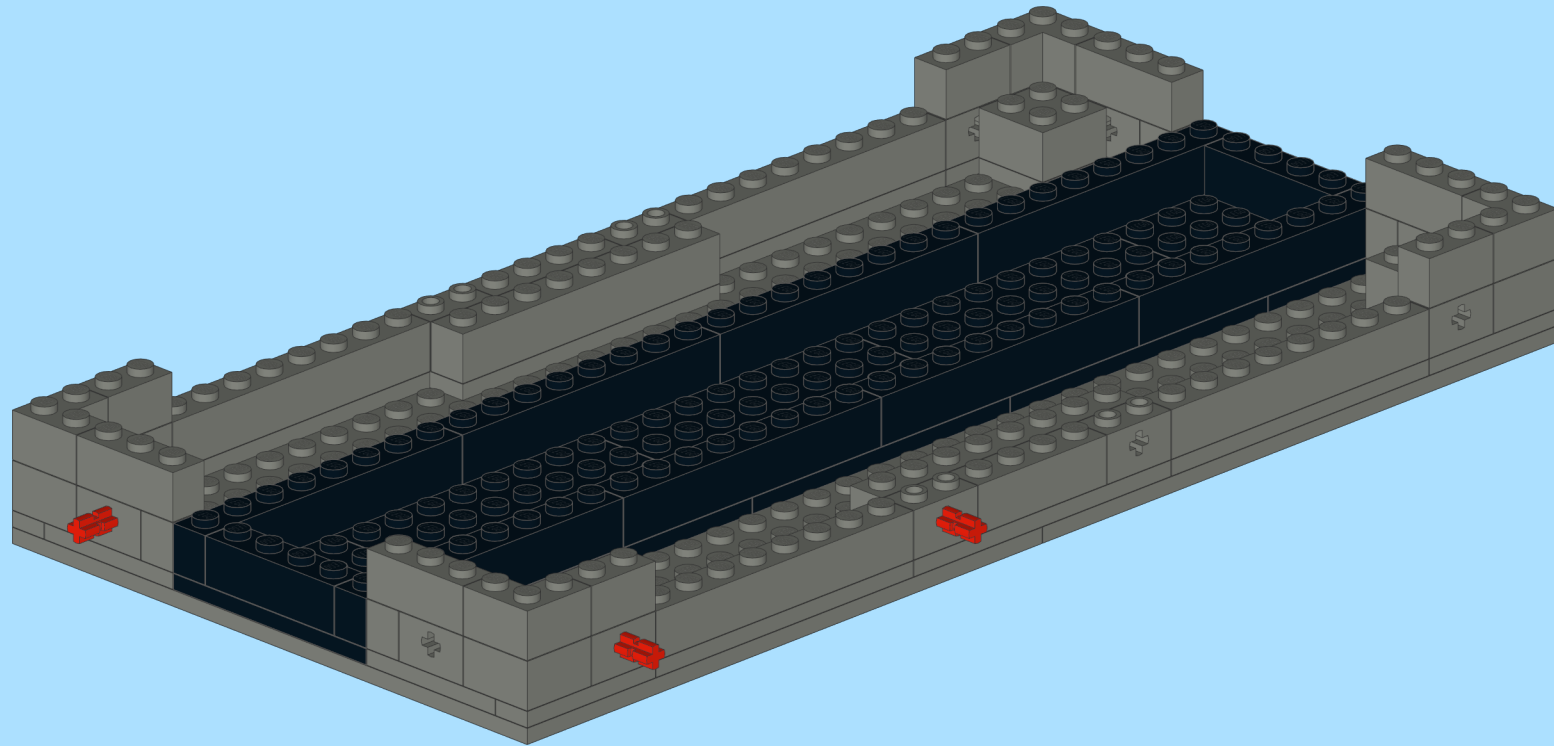
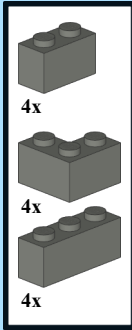

7

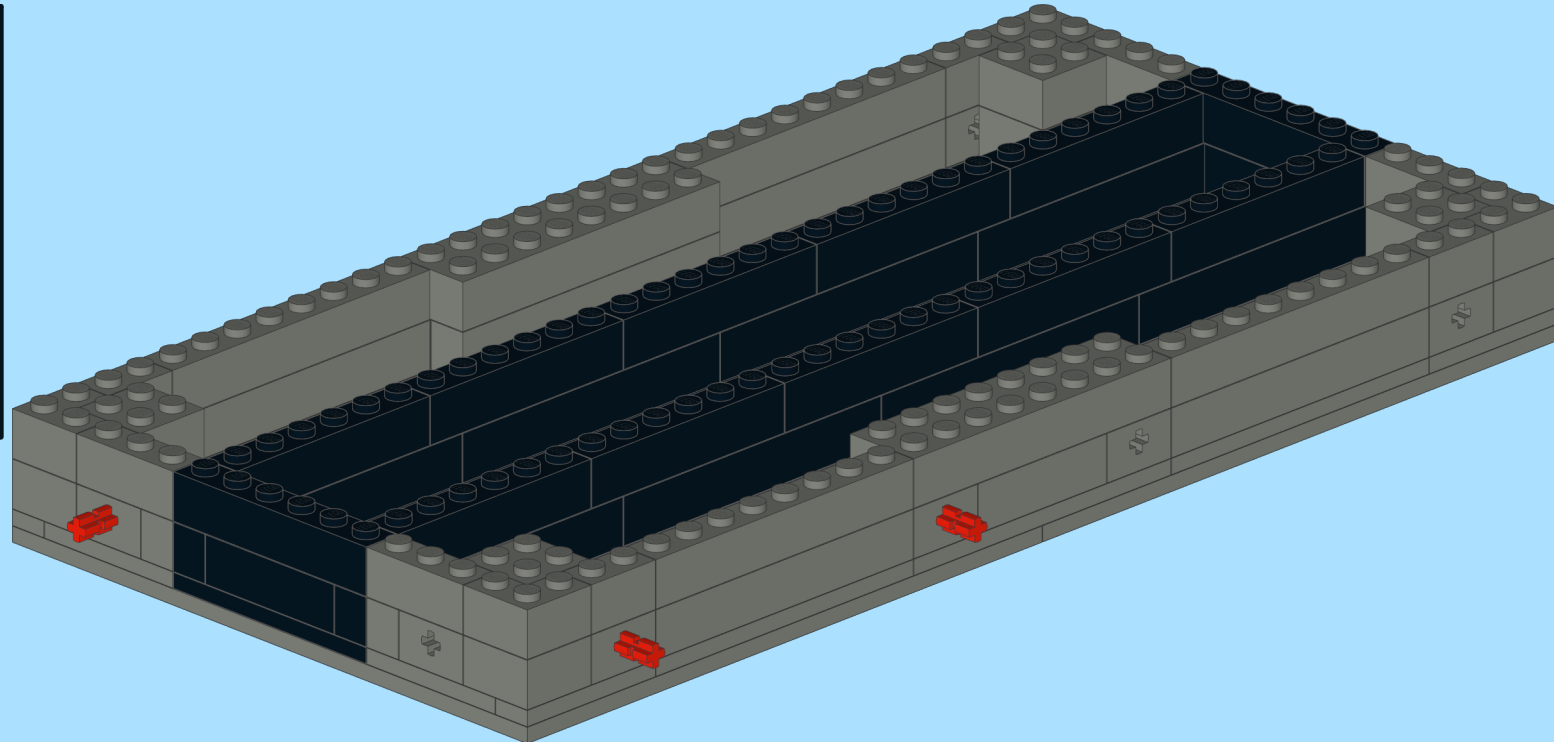
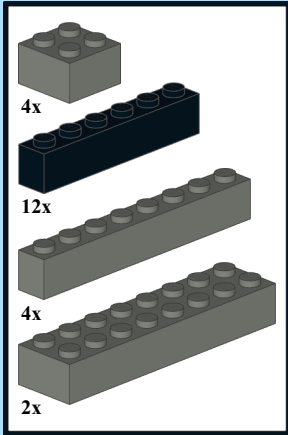

8

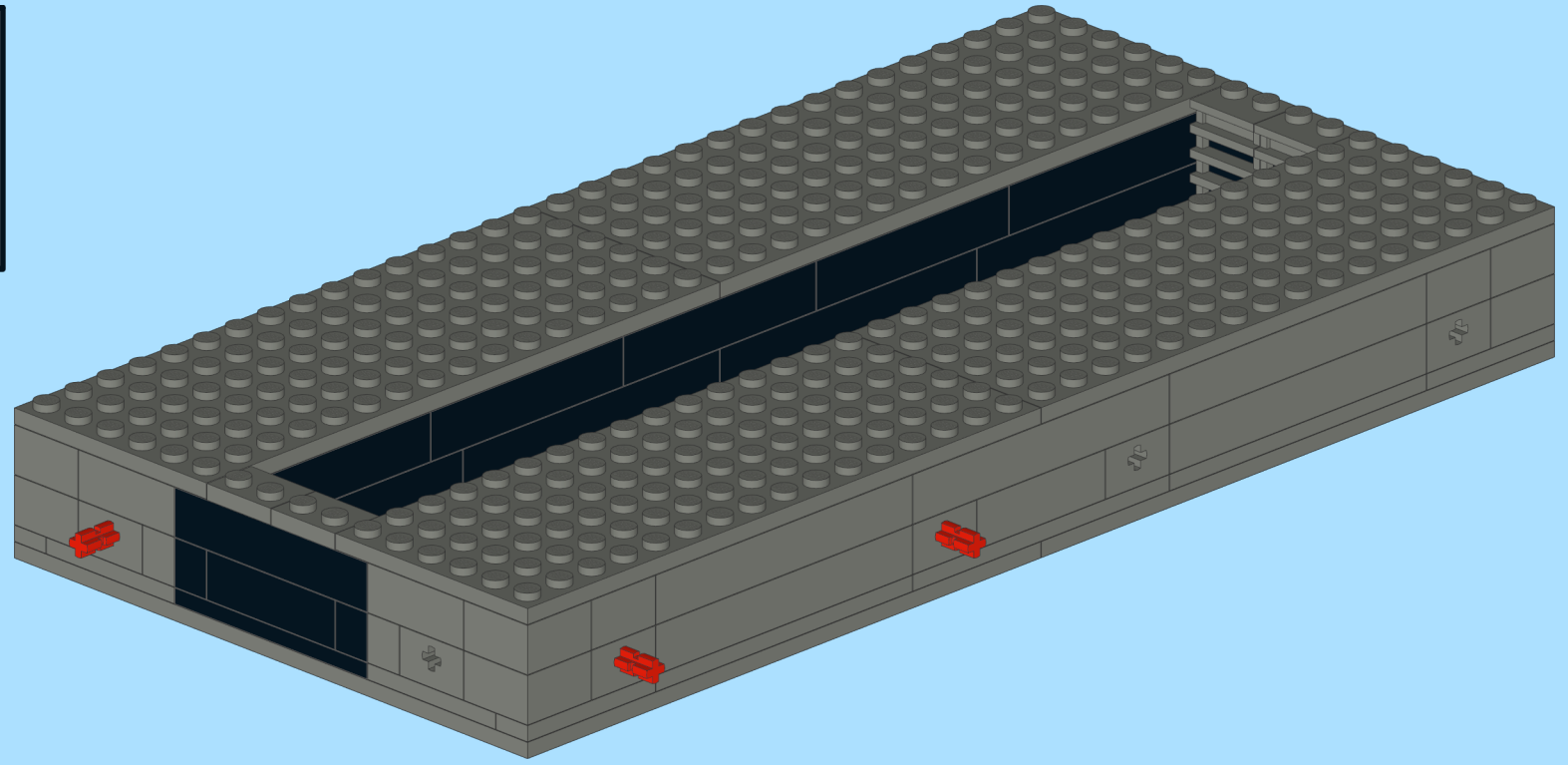
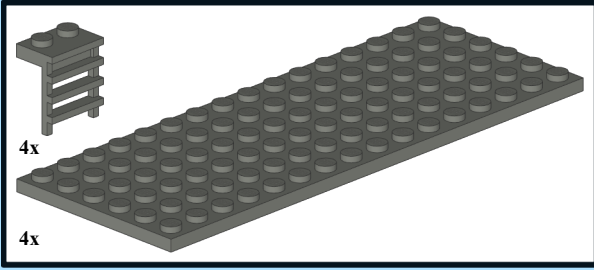

9

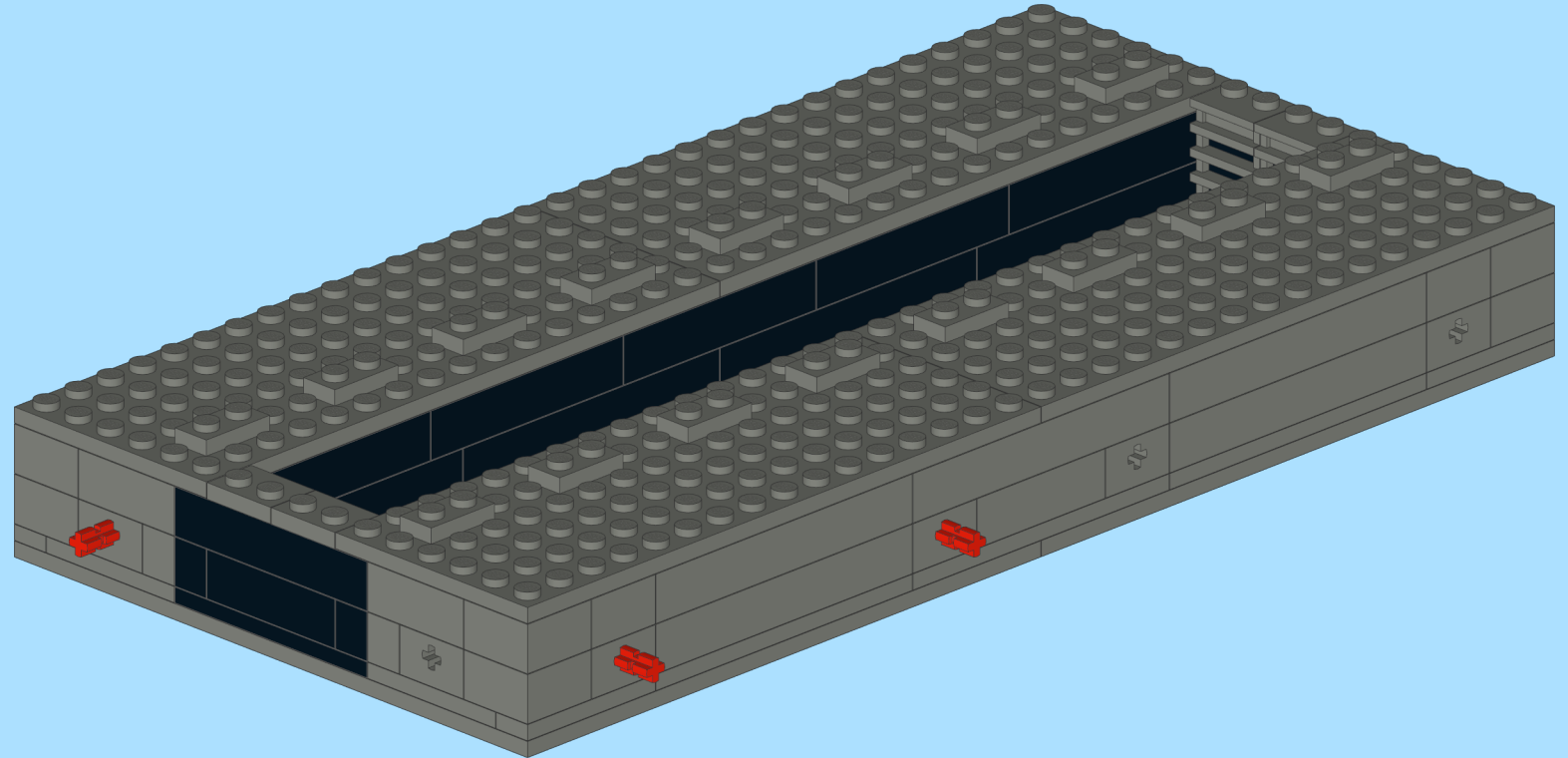
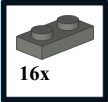

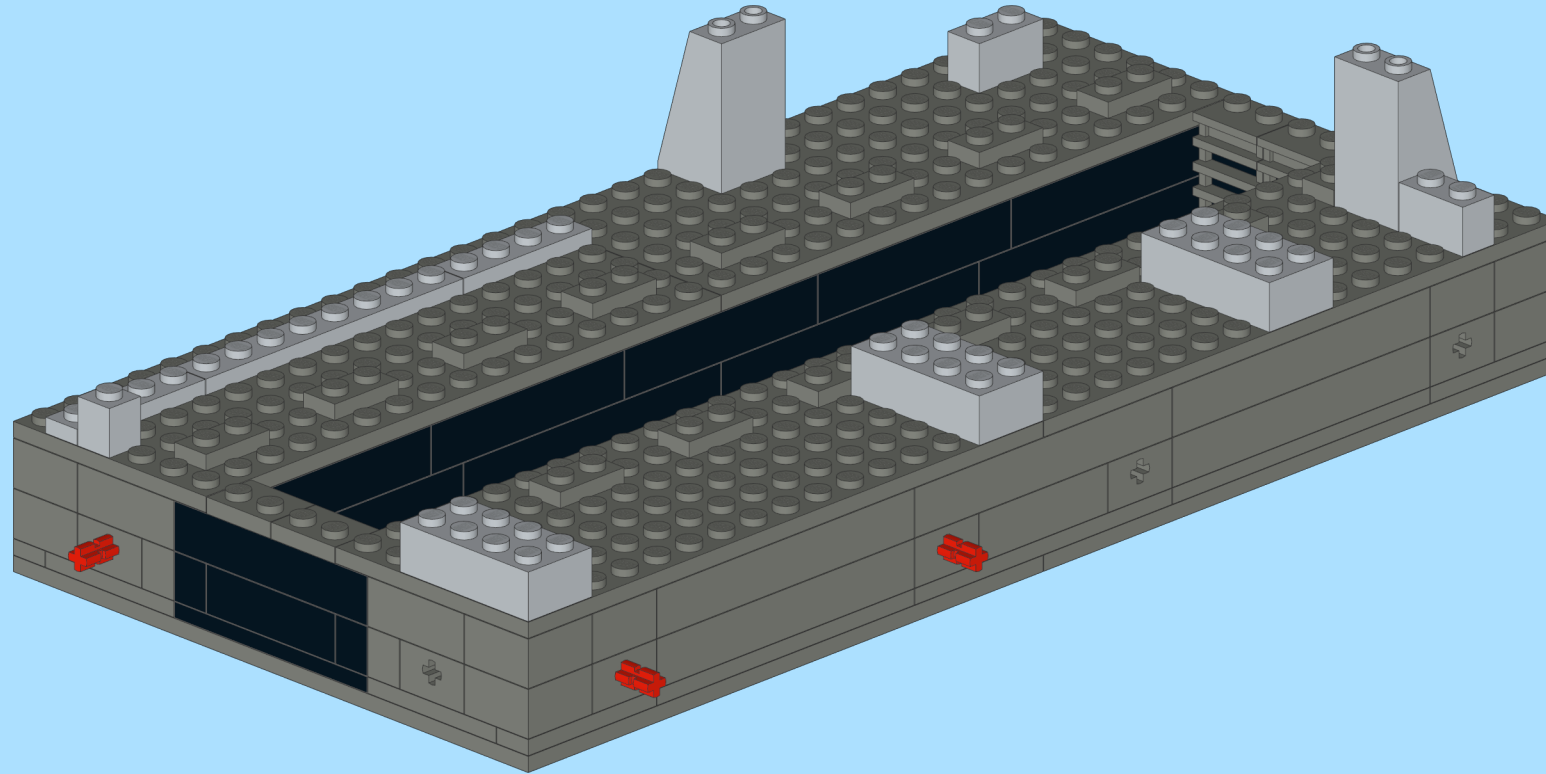
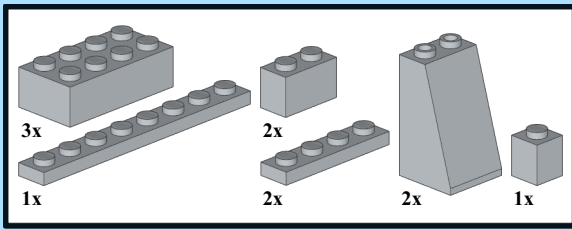

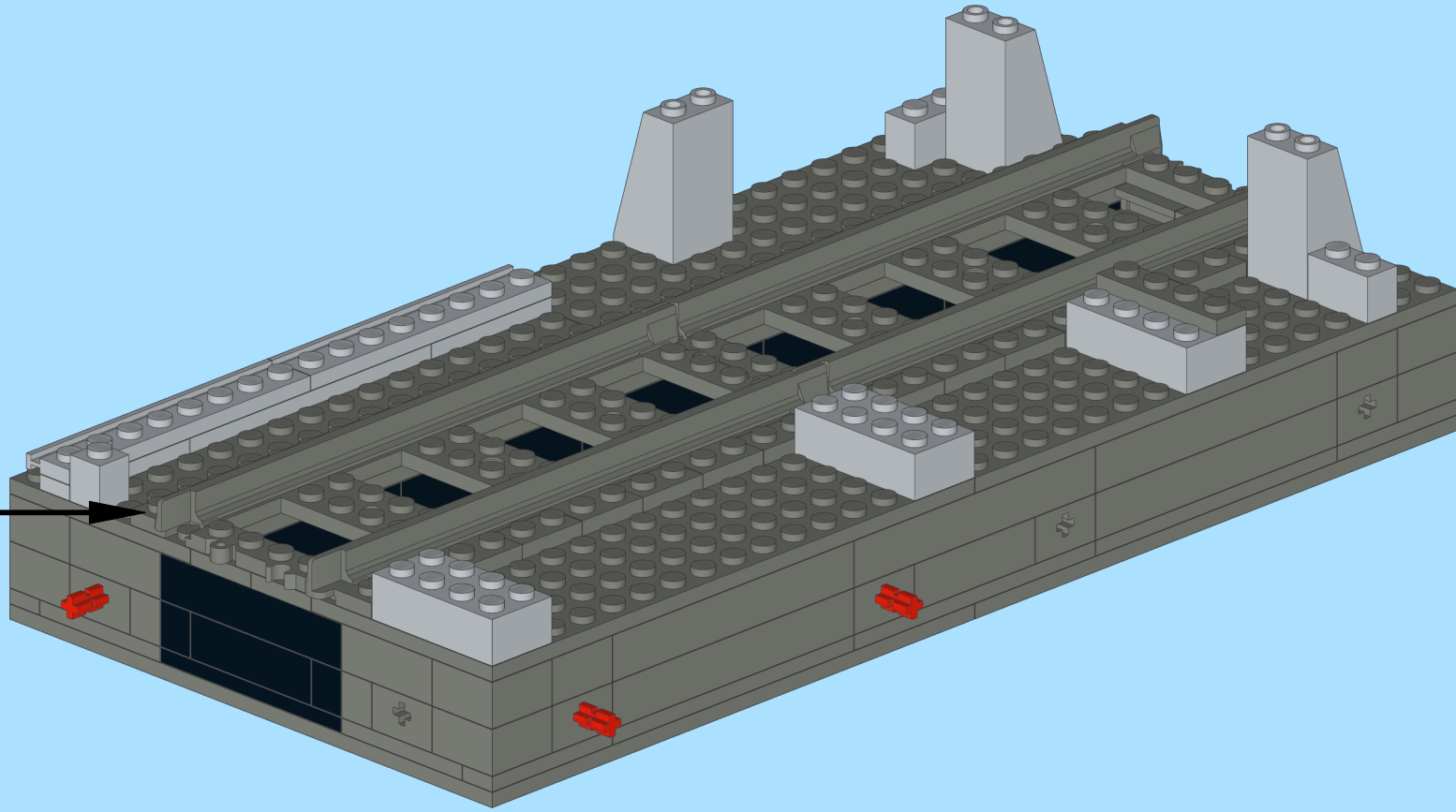
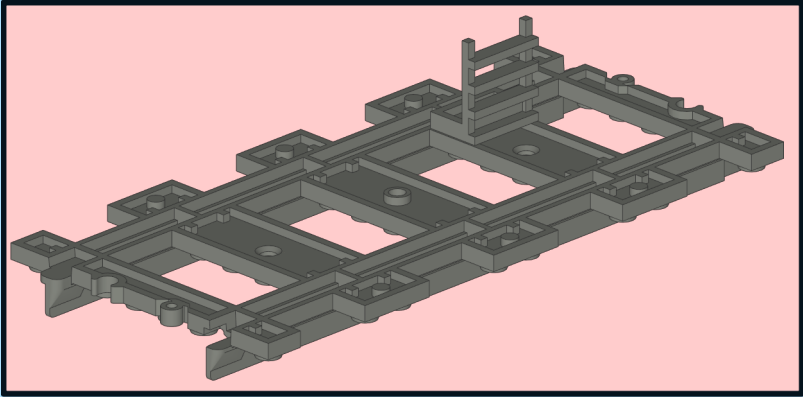
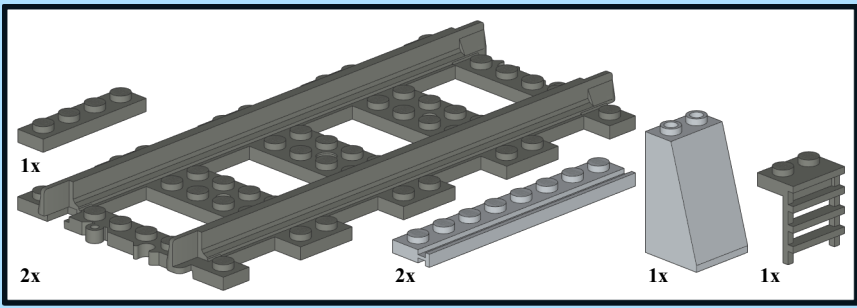

12

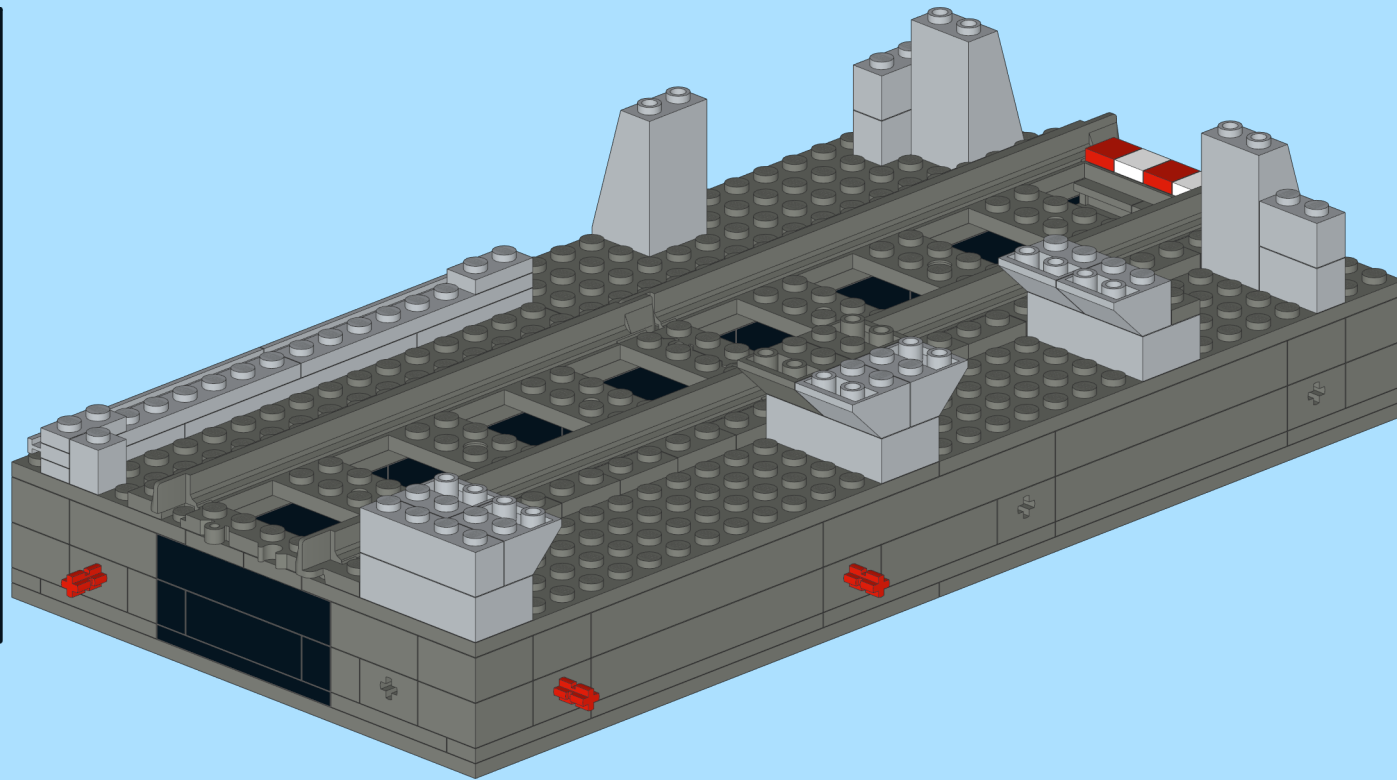
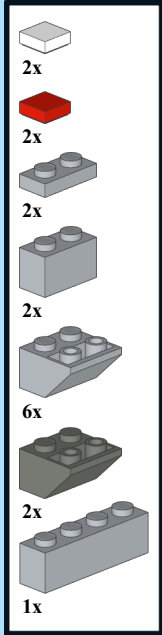

13

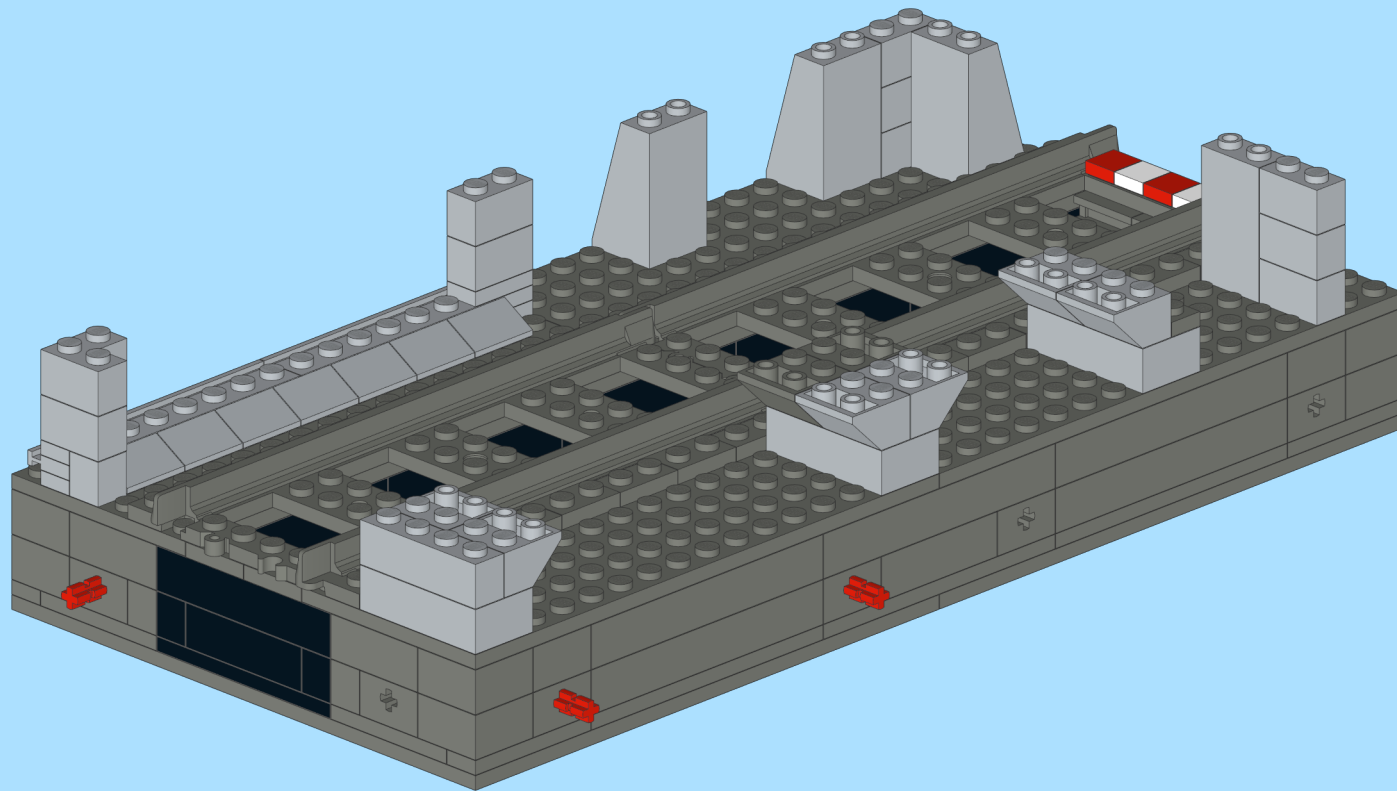
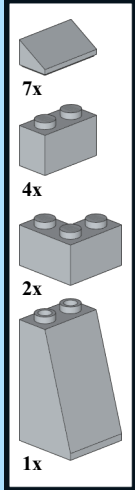

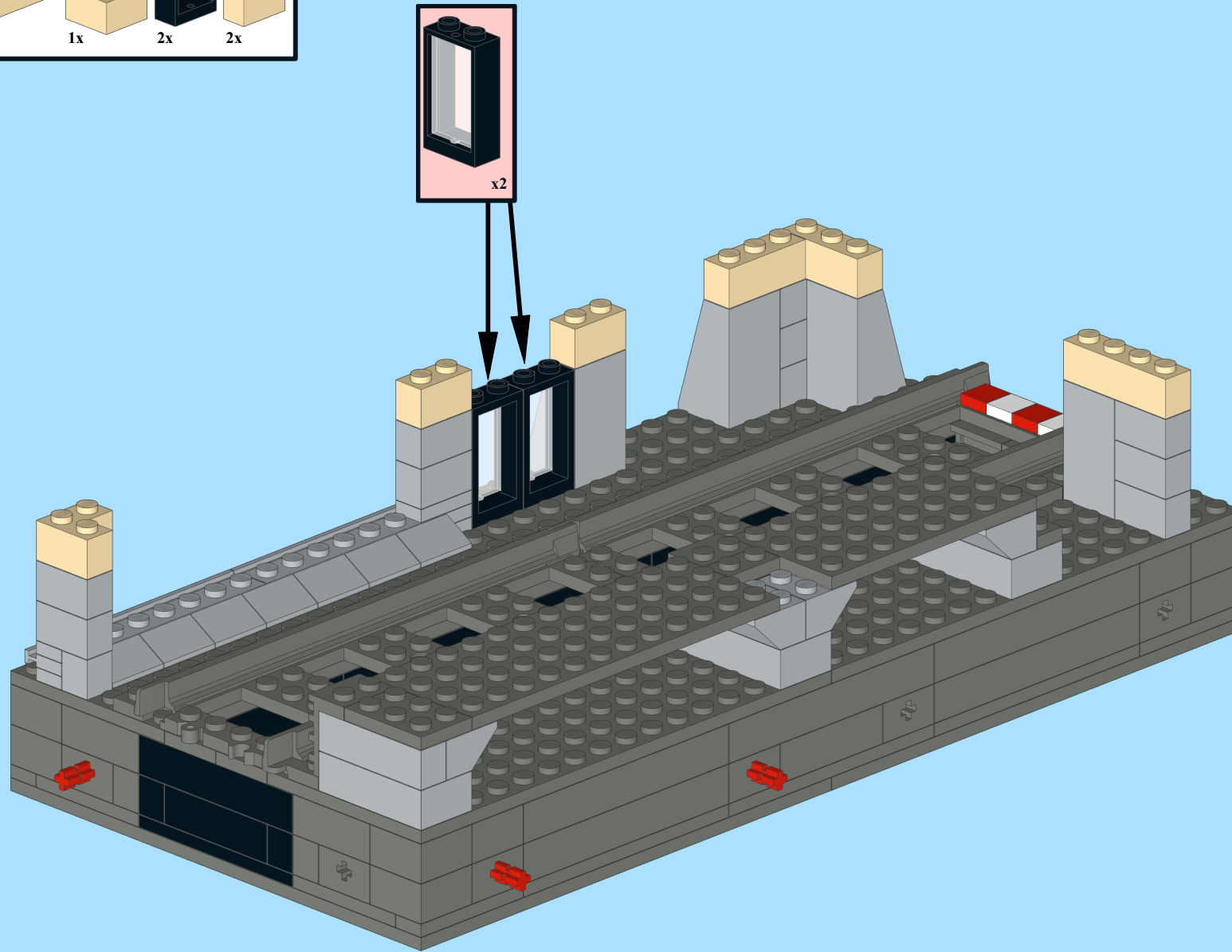
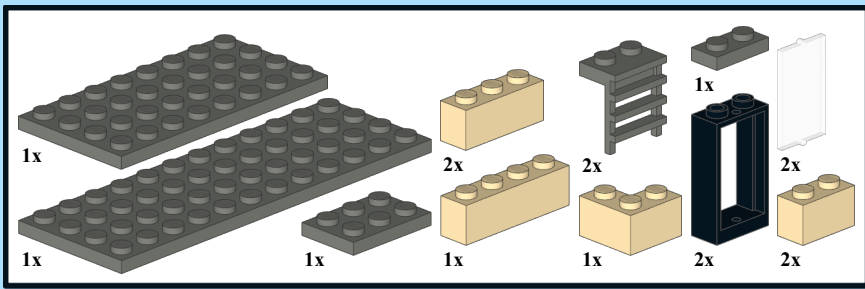

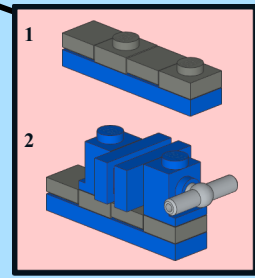
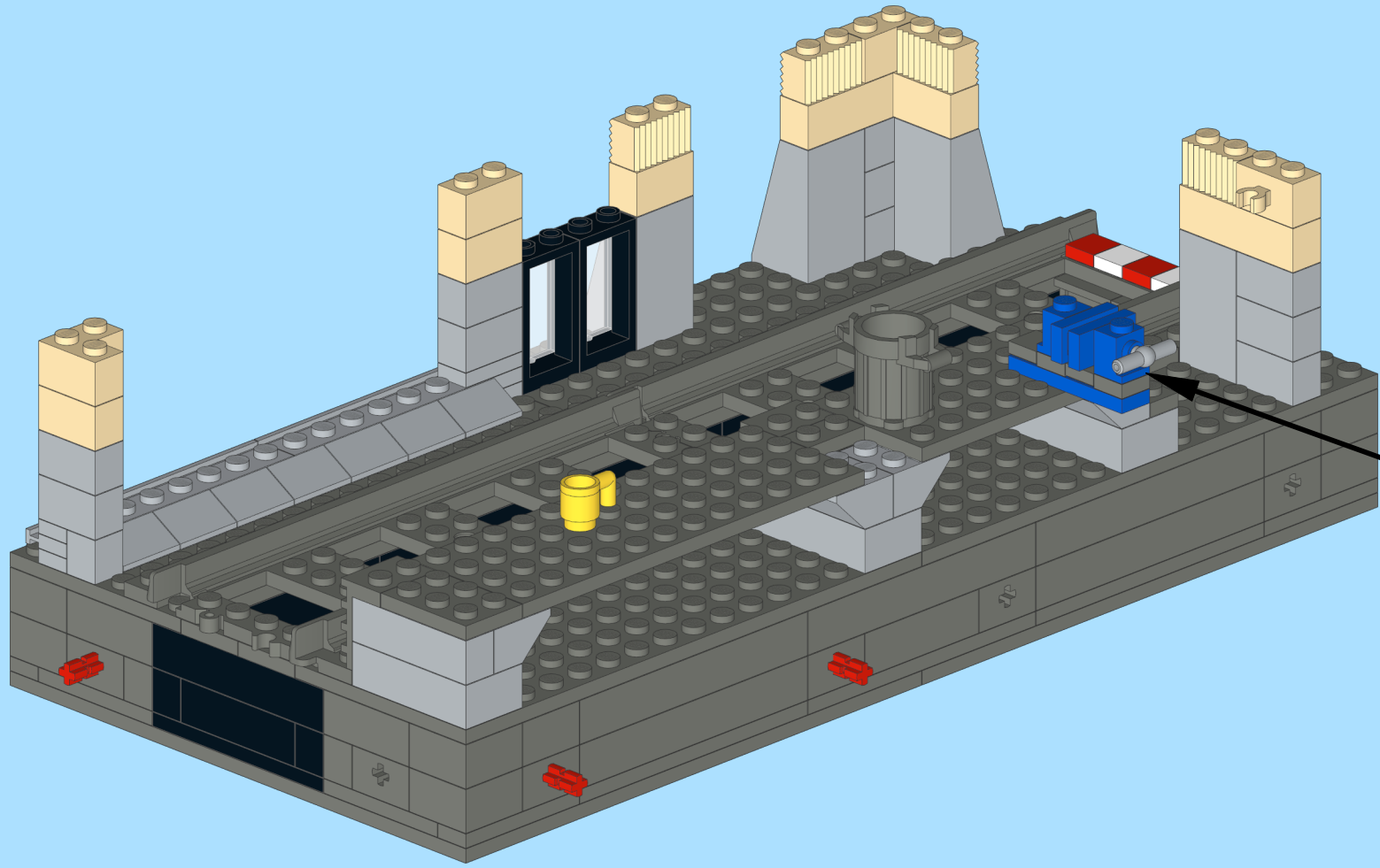
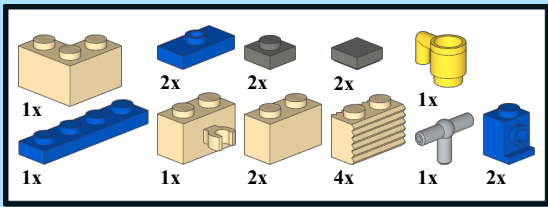

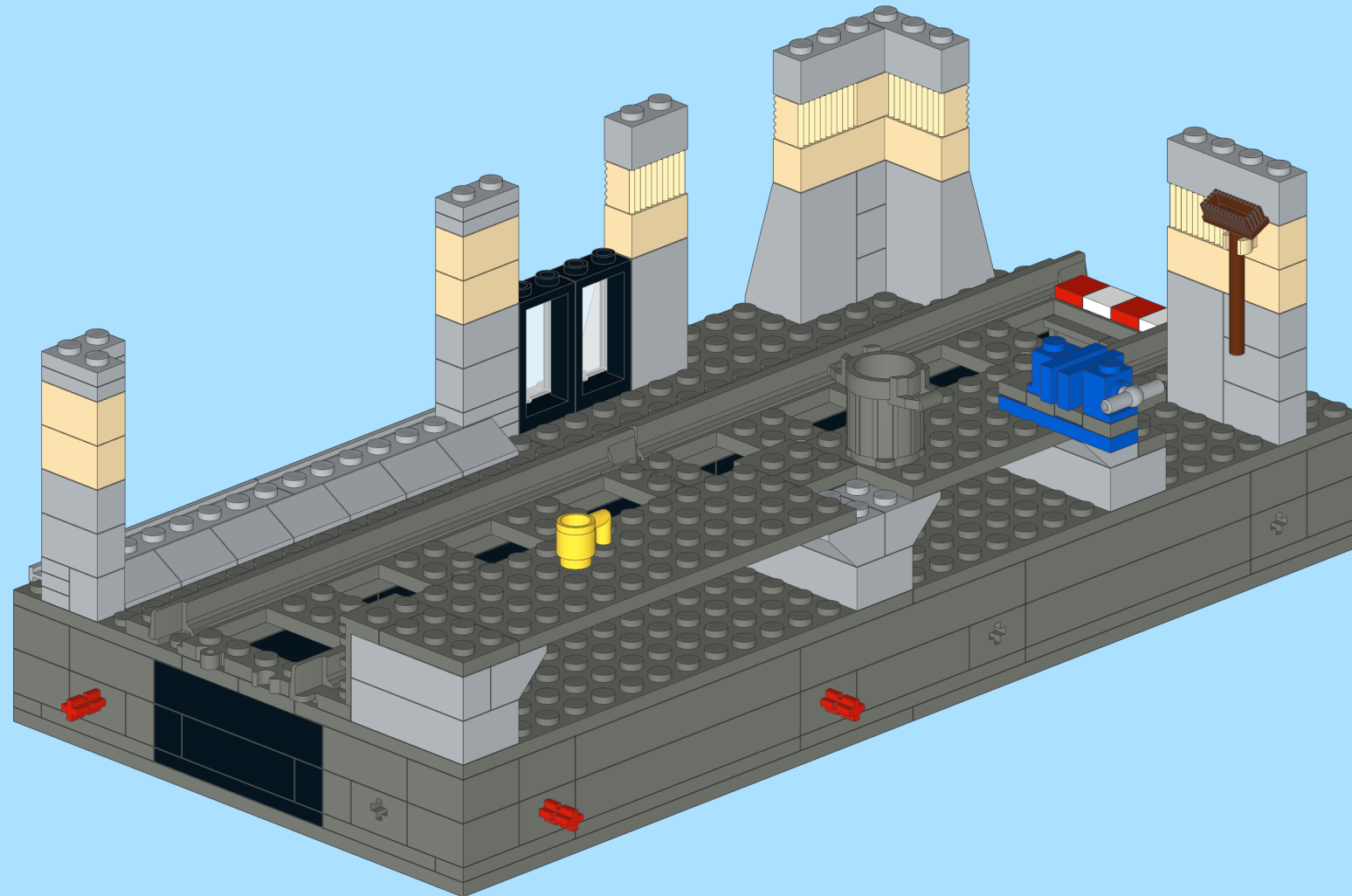
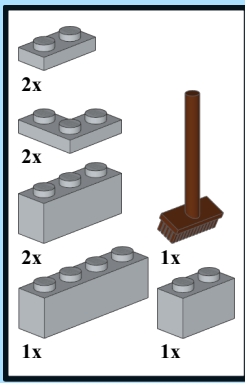

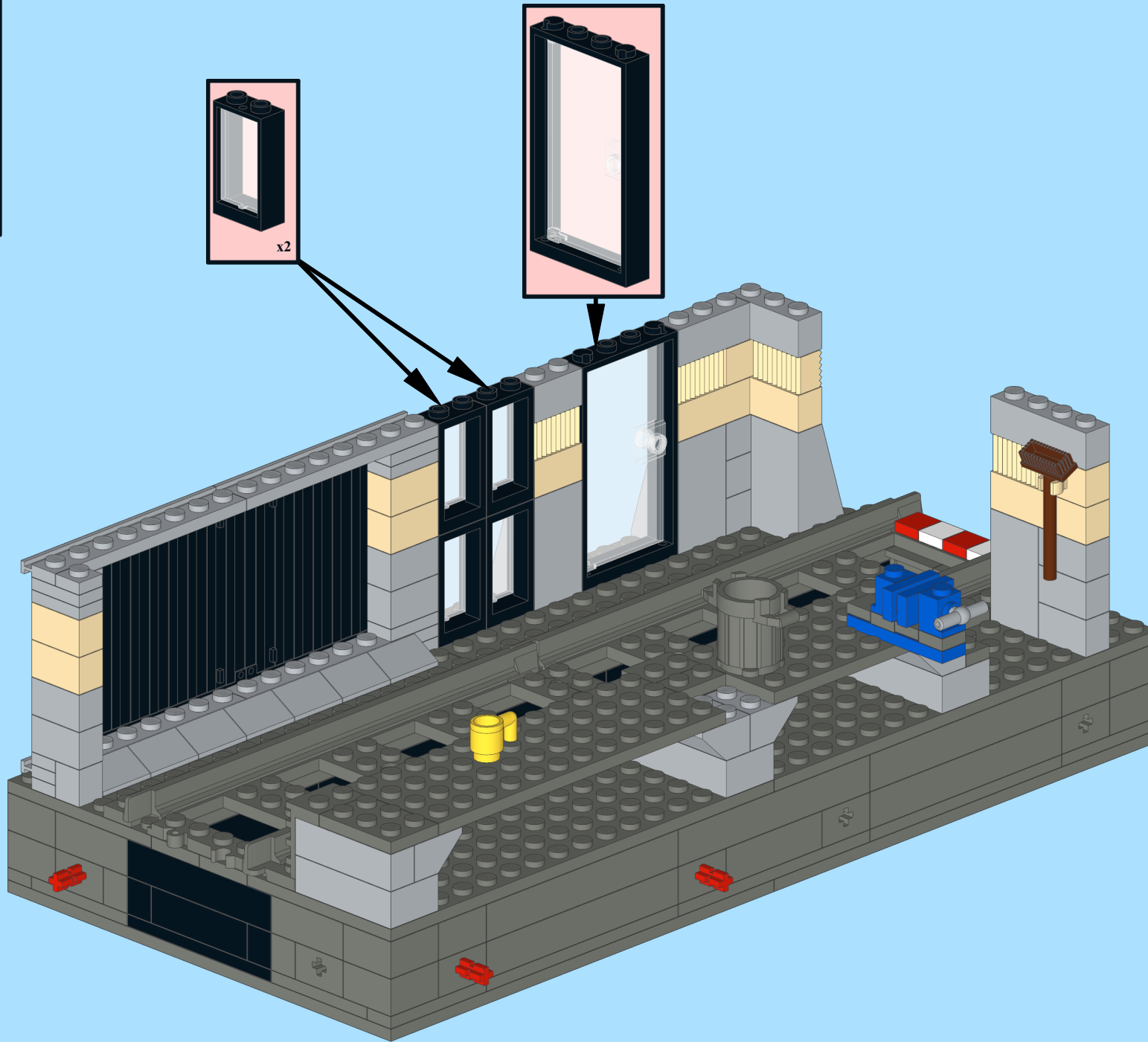
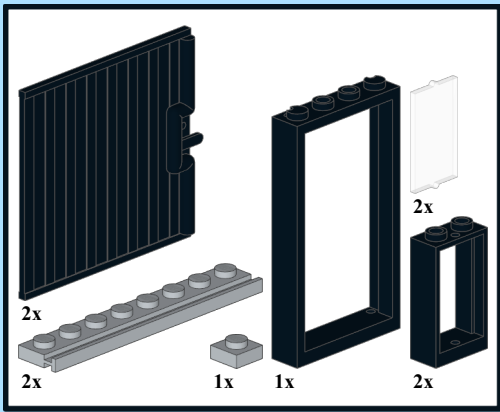

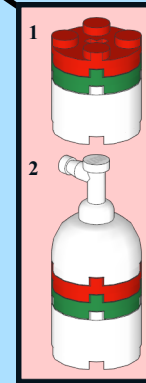
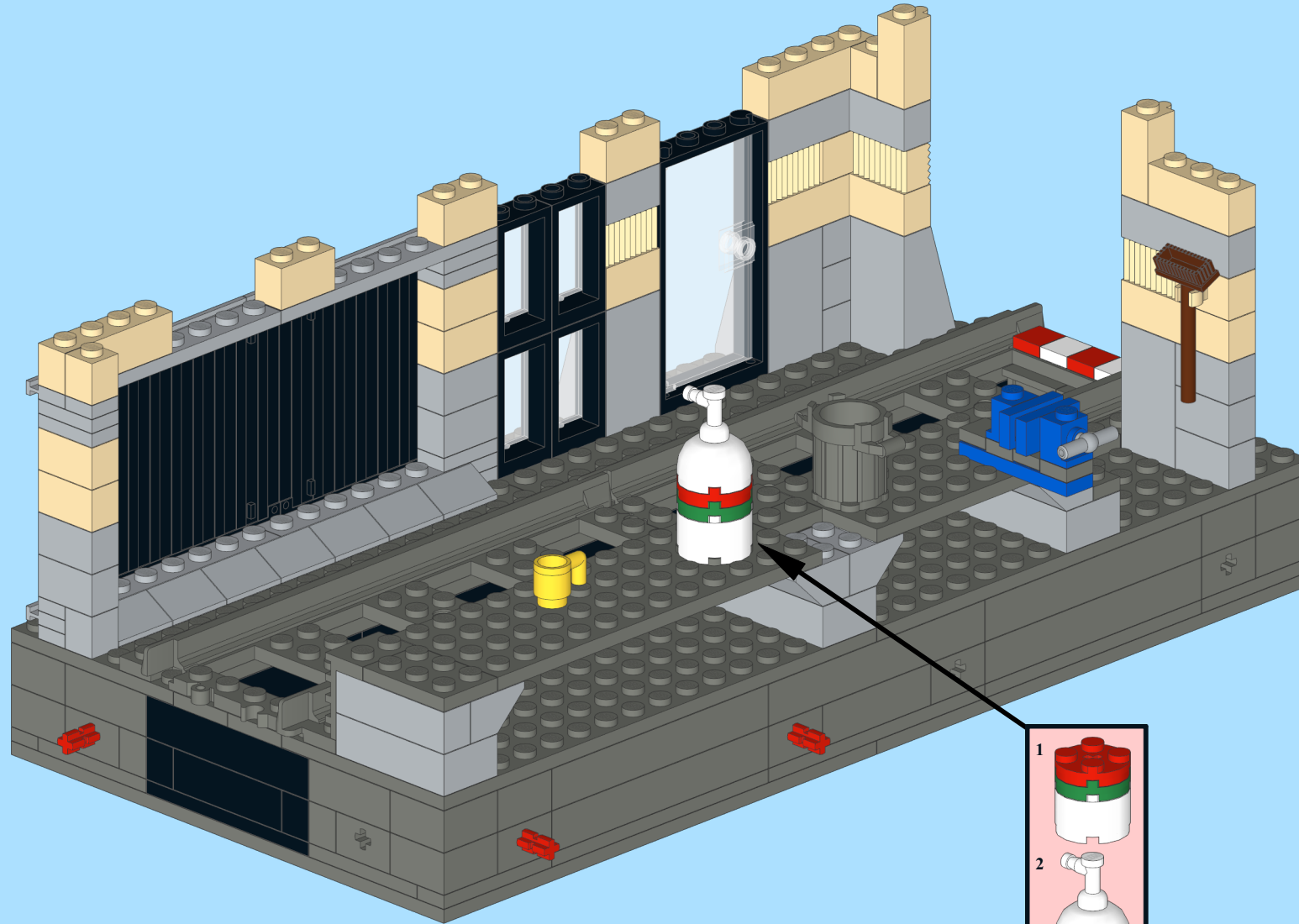
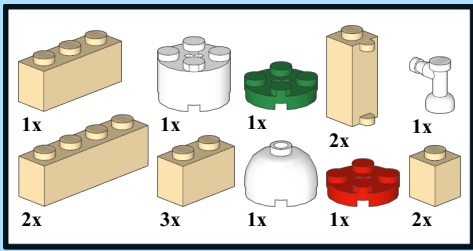

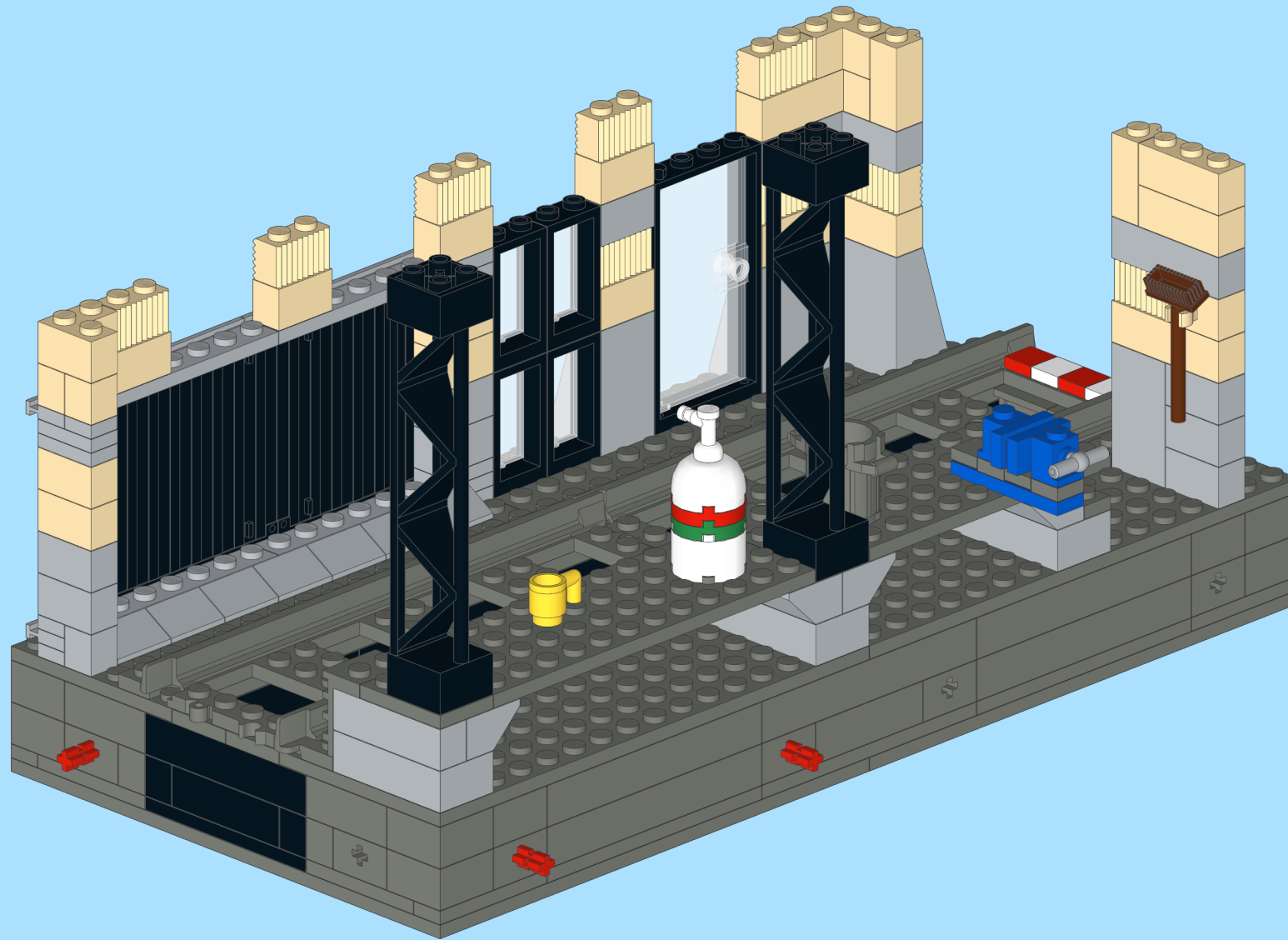
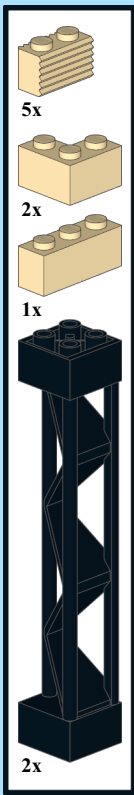

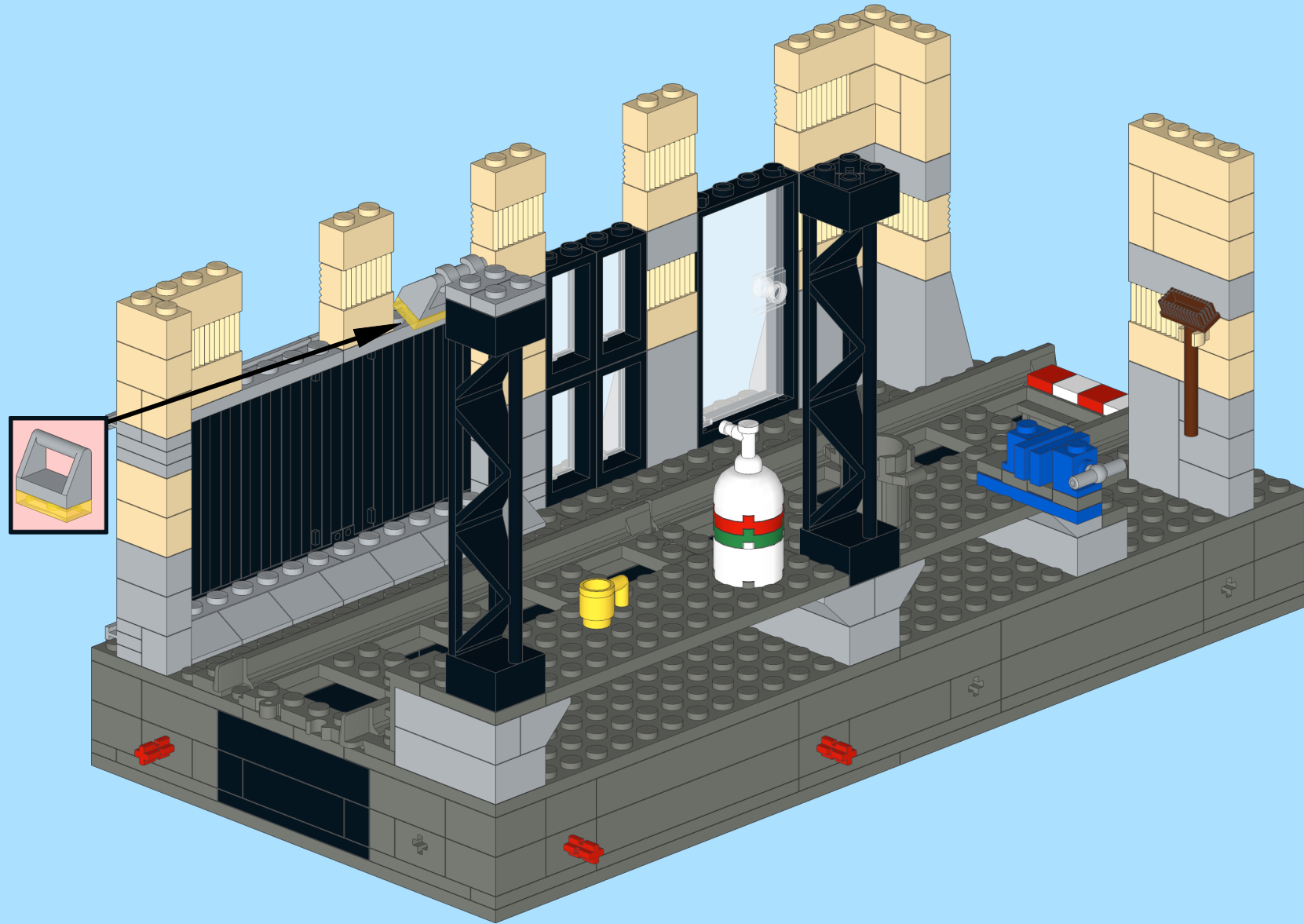
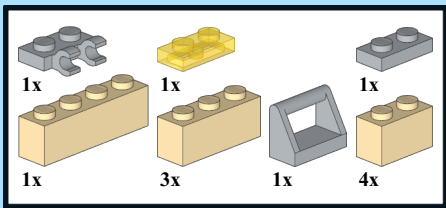

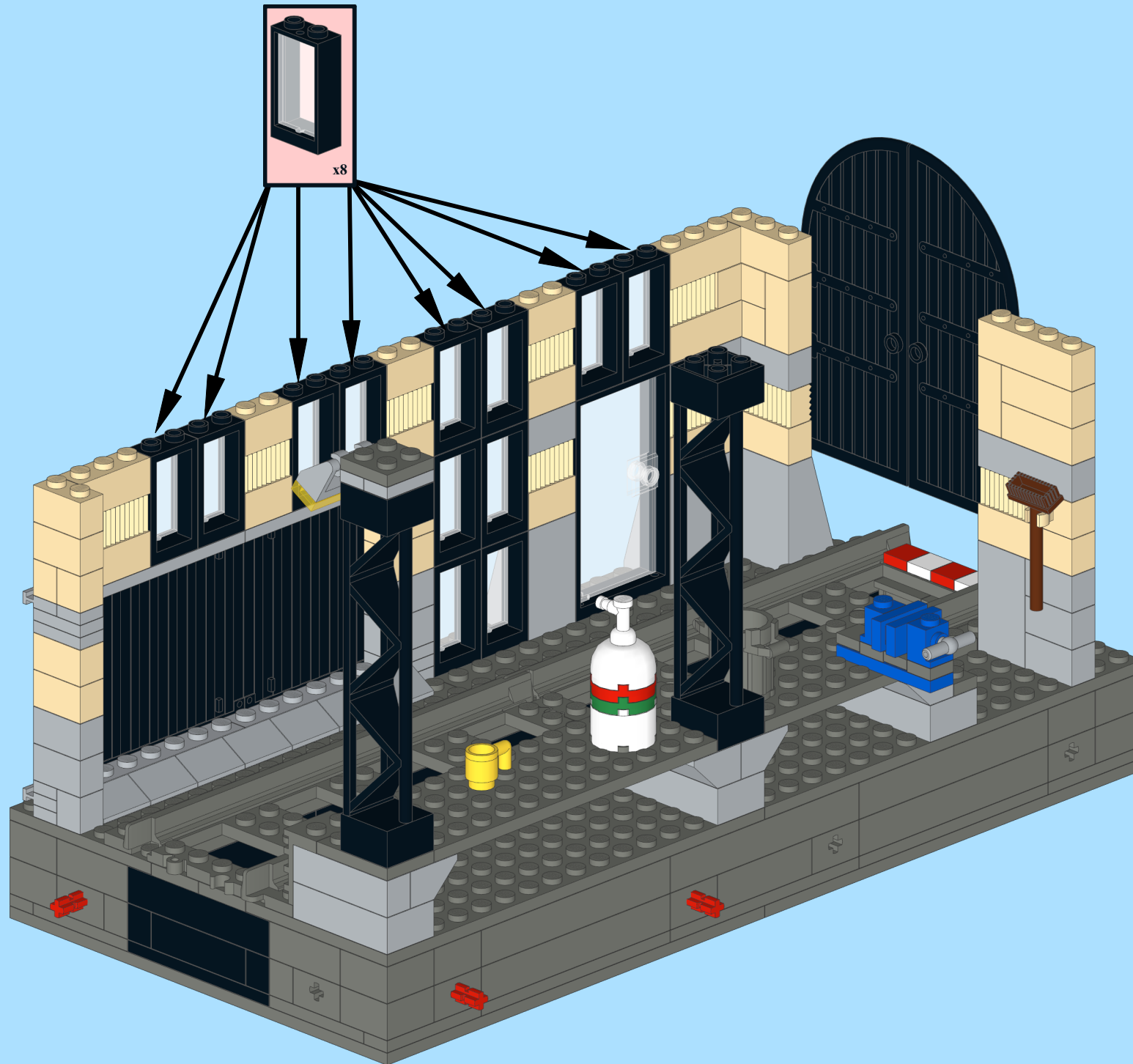
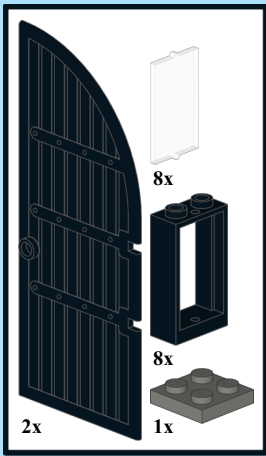

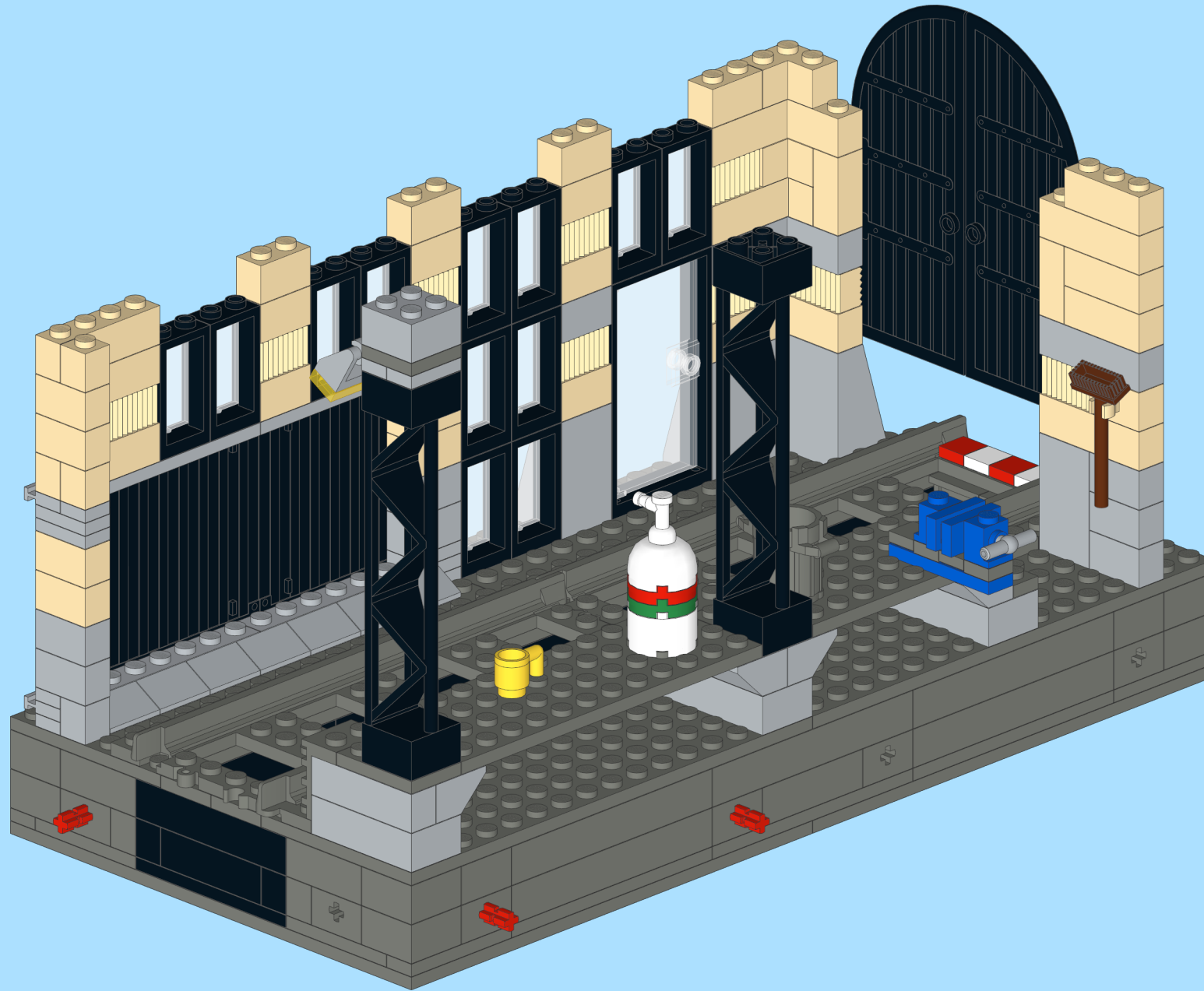
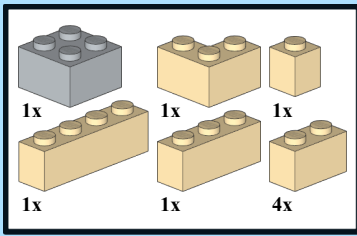

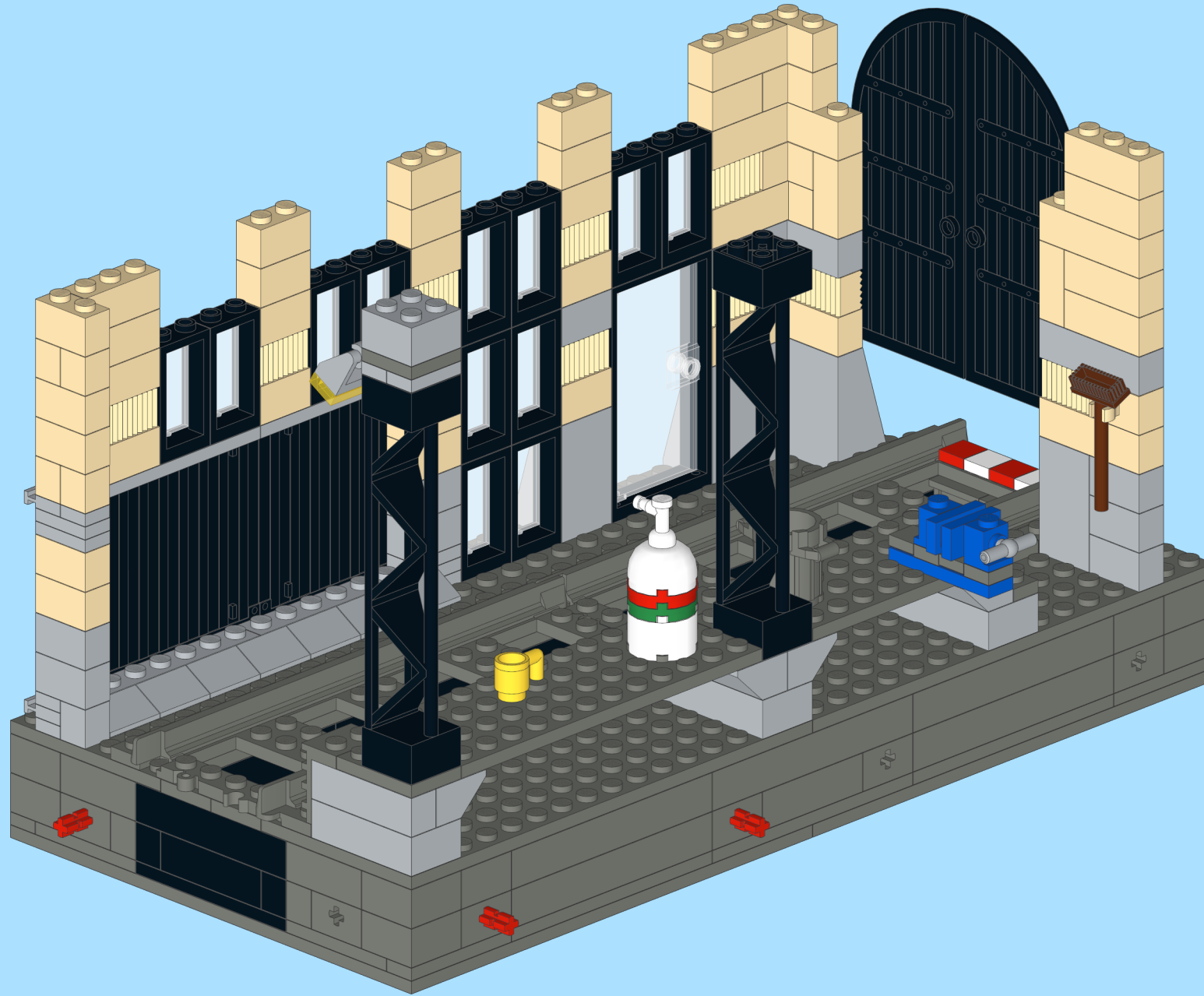
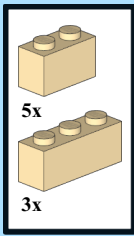

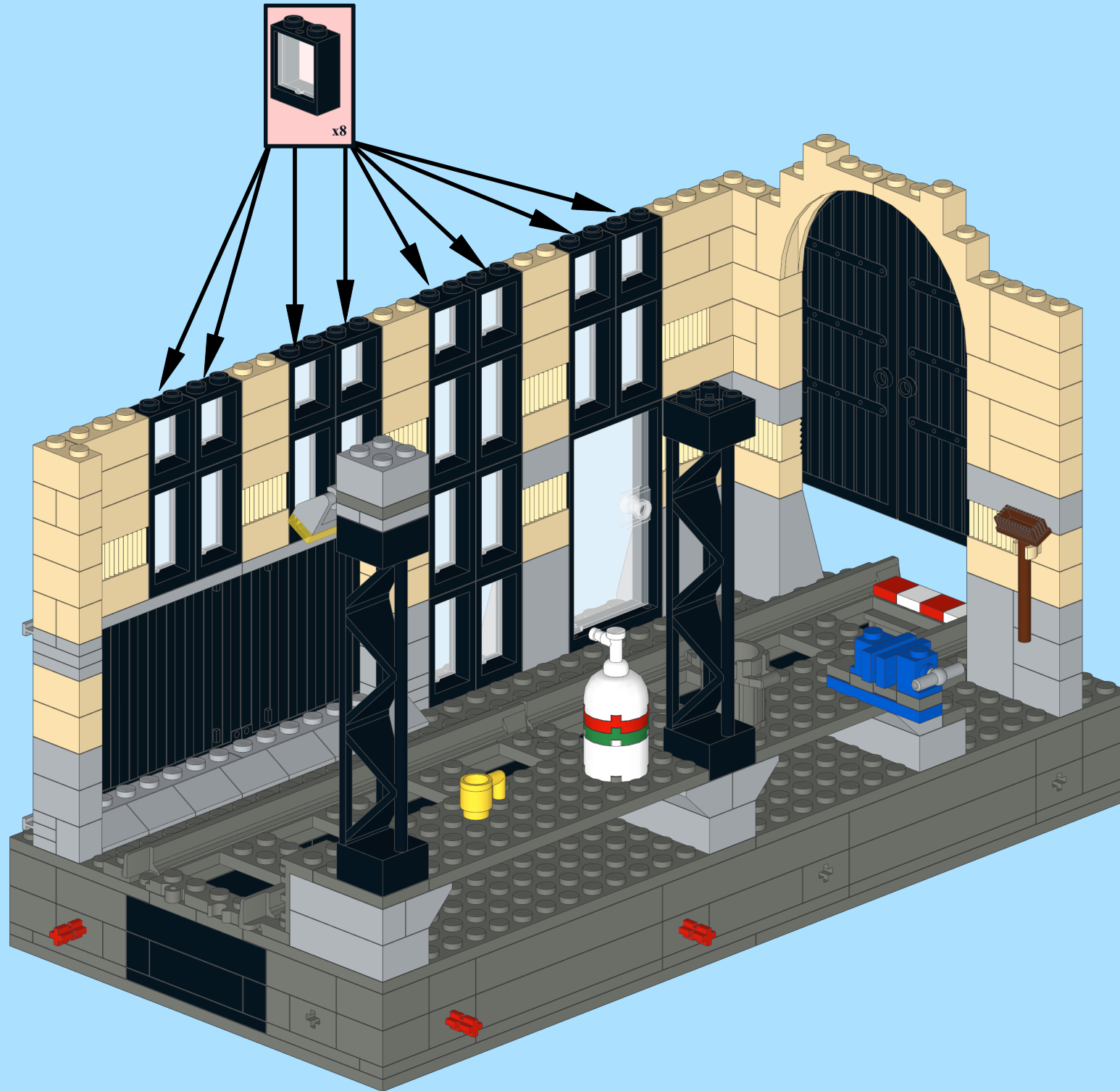
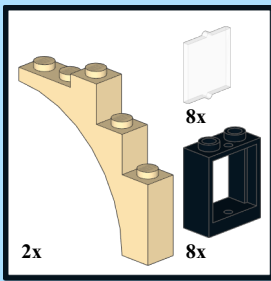

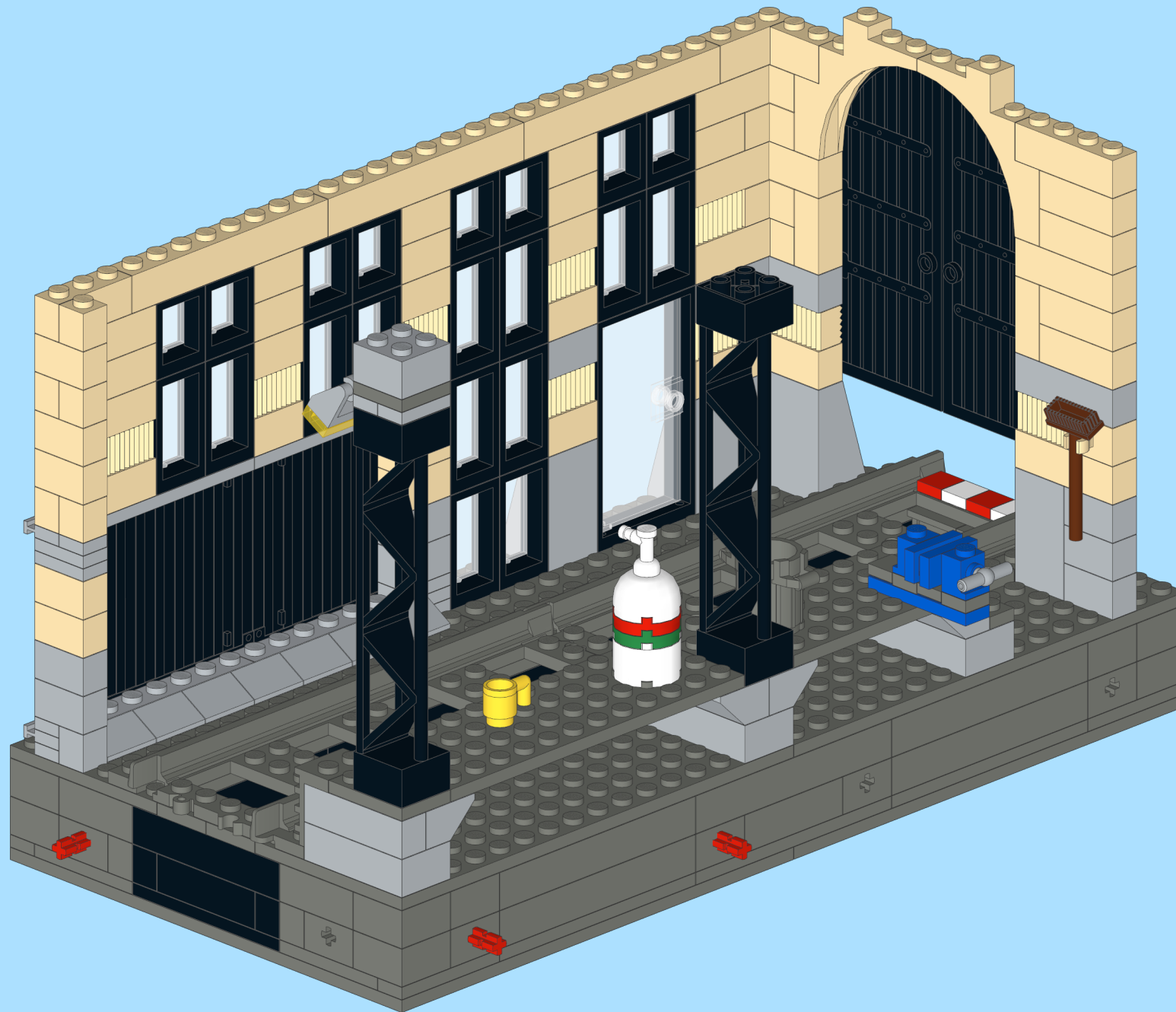
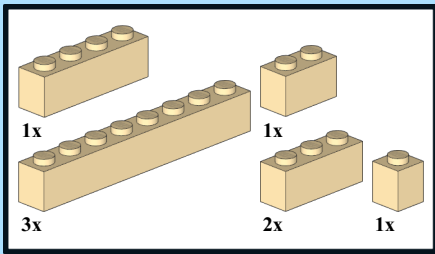

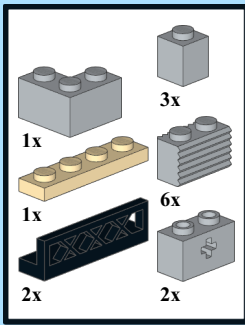

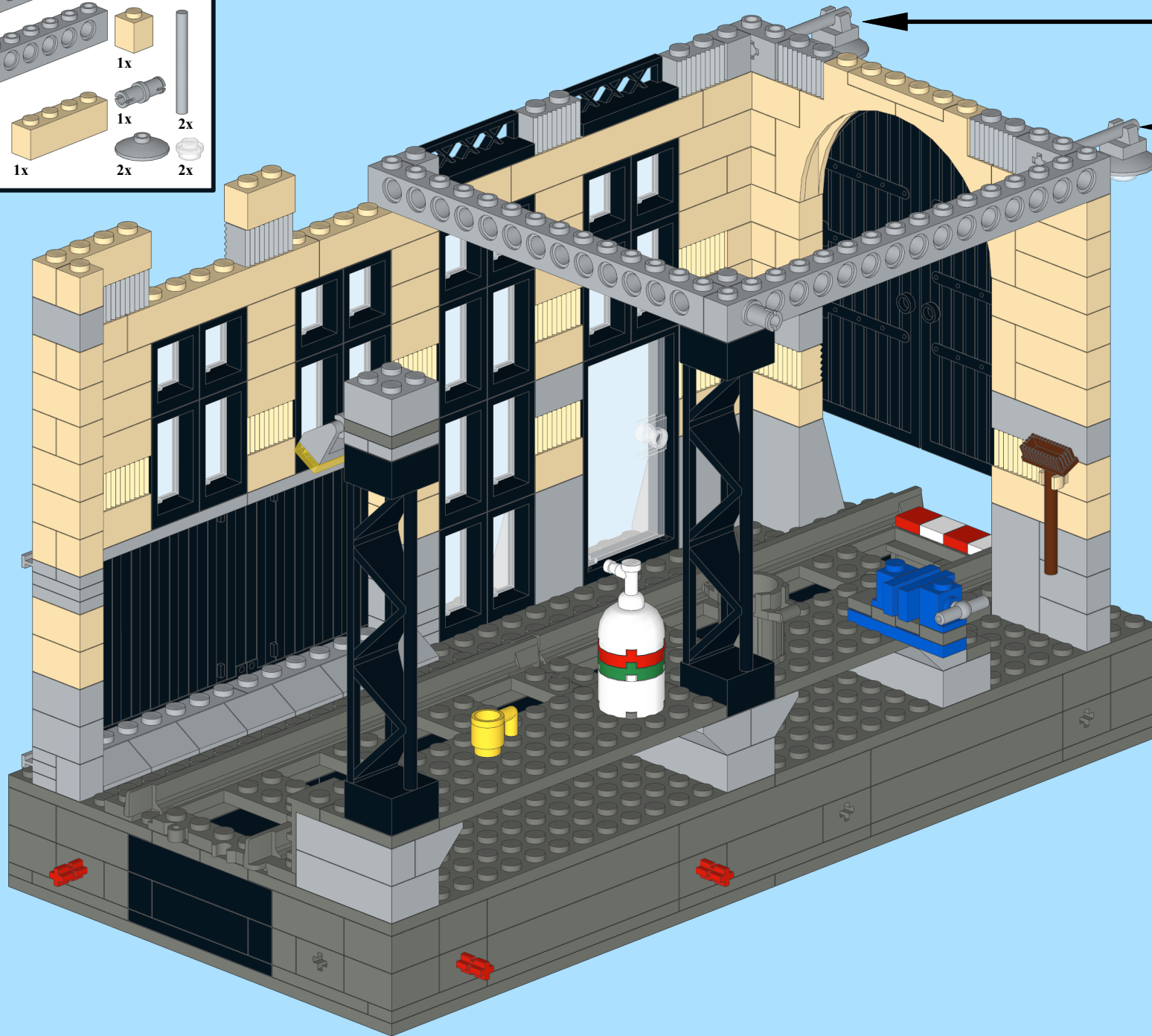
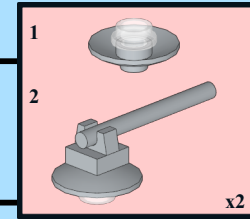
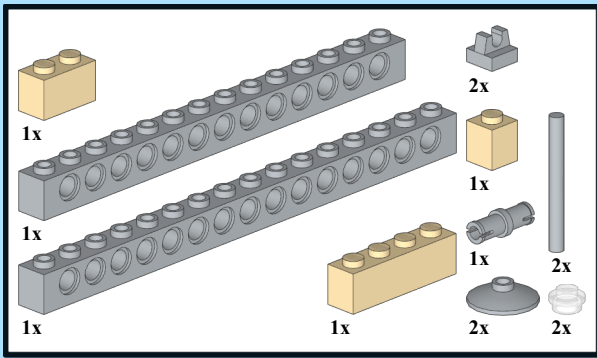

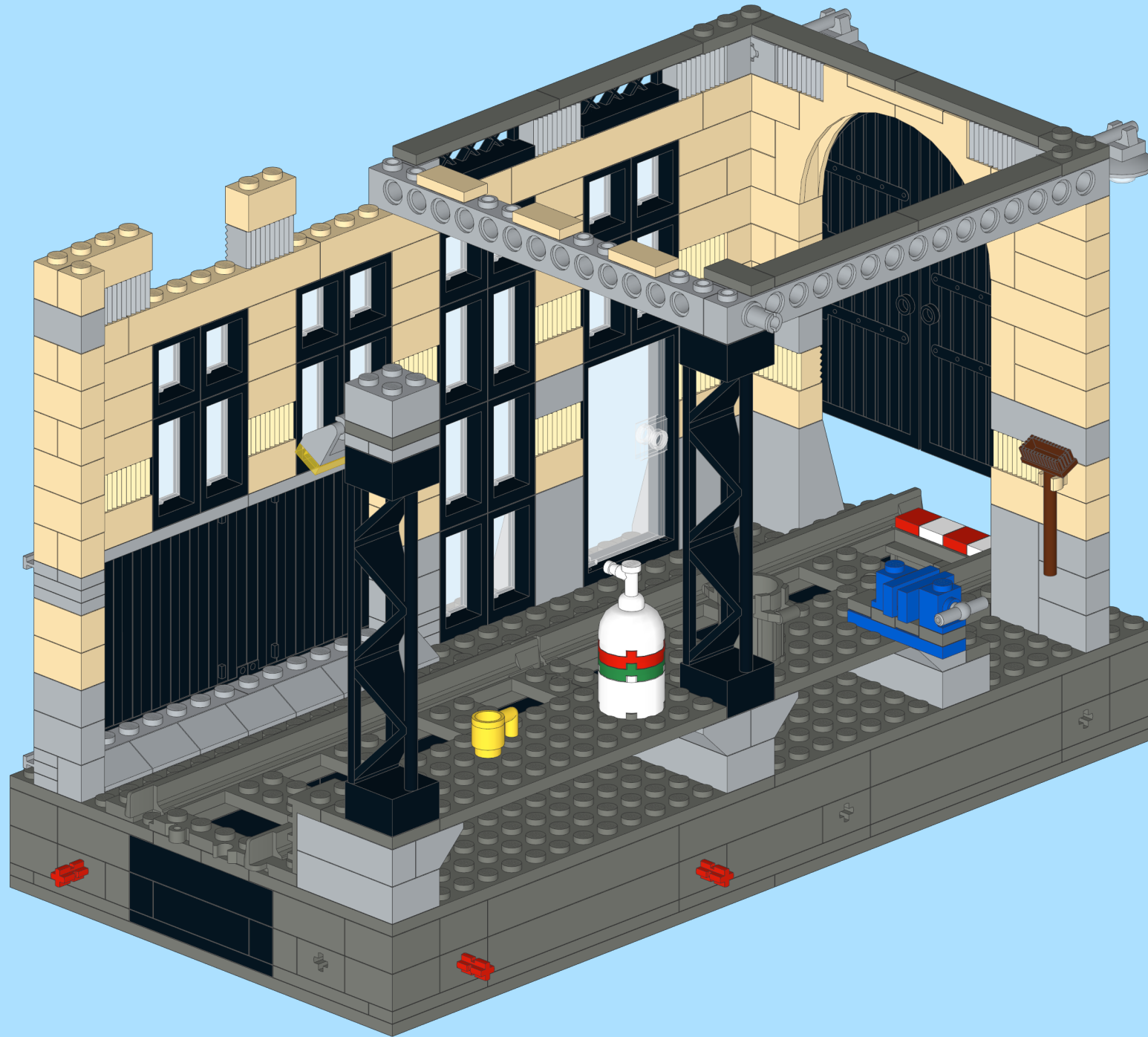
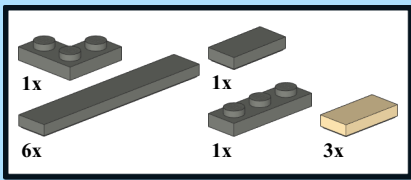

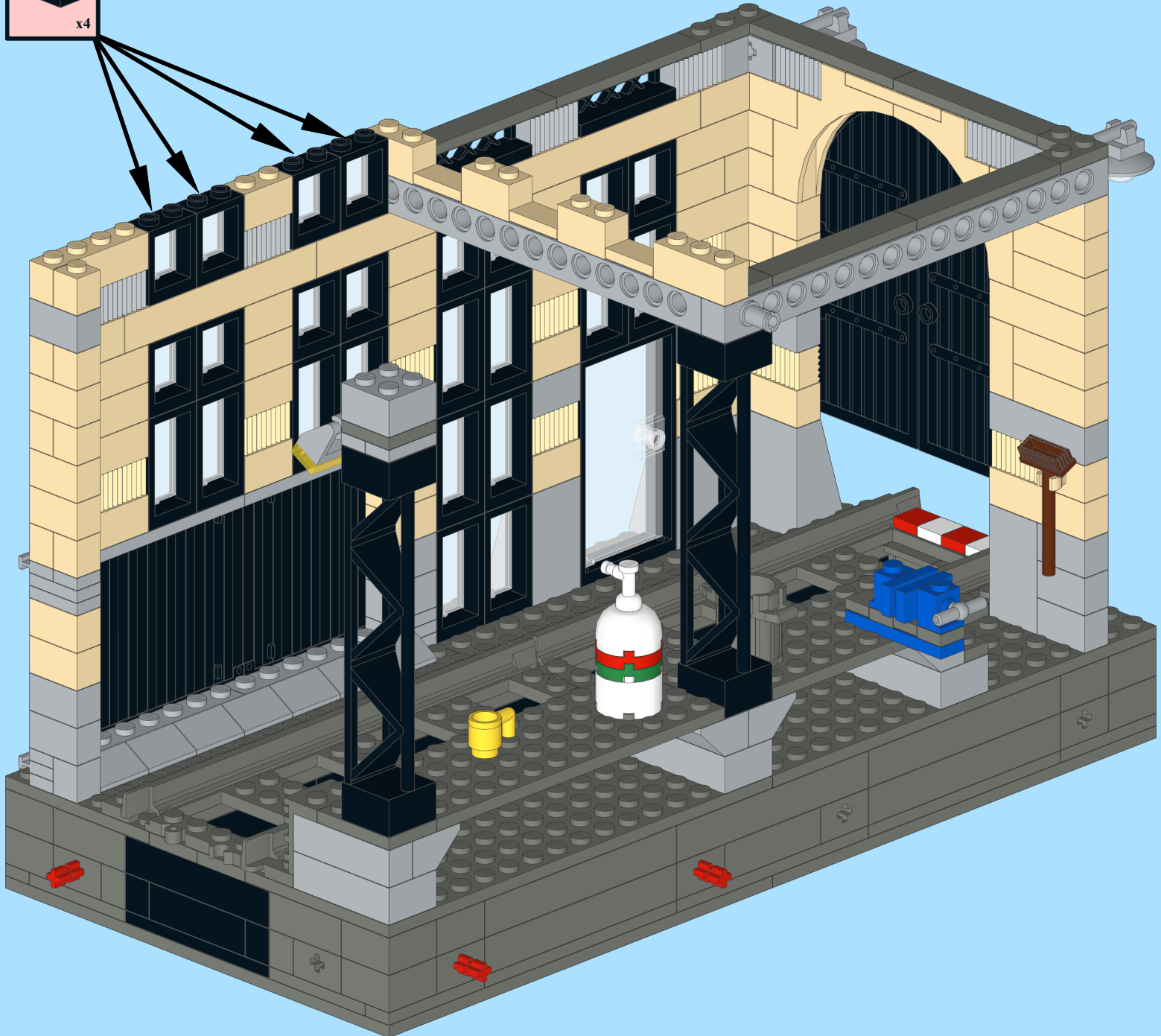
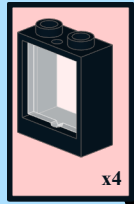
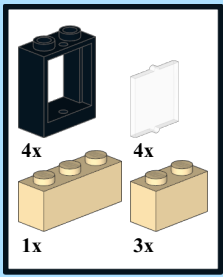

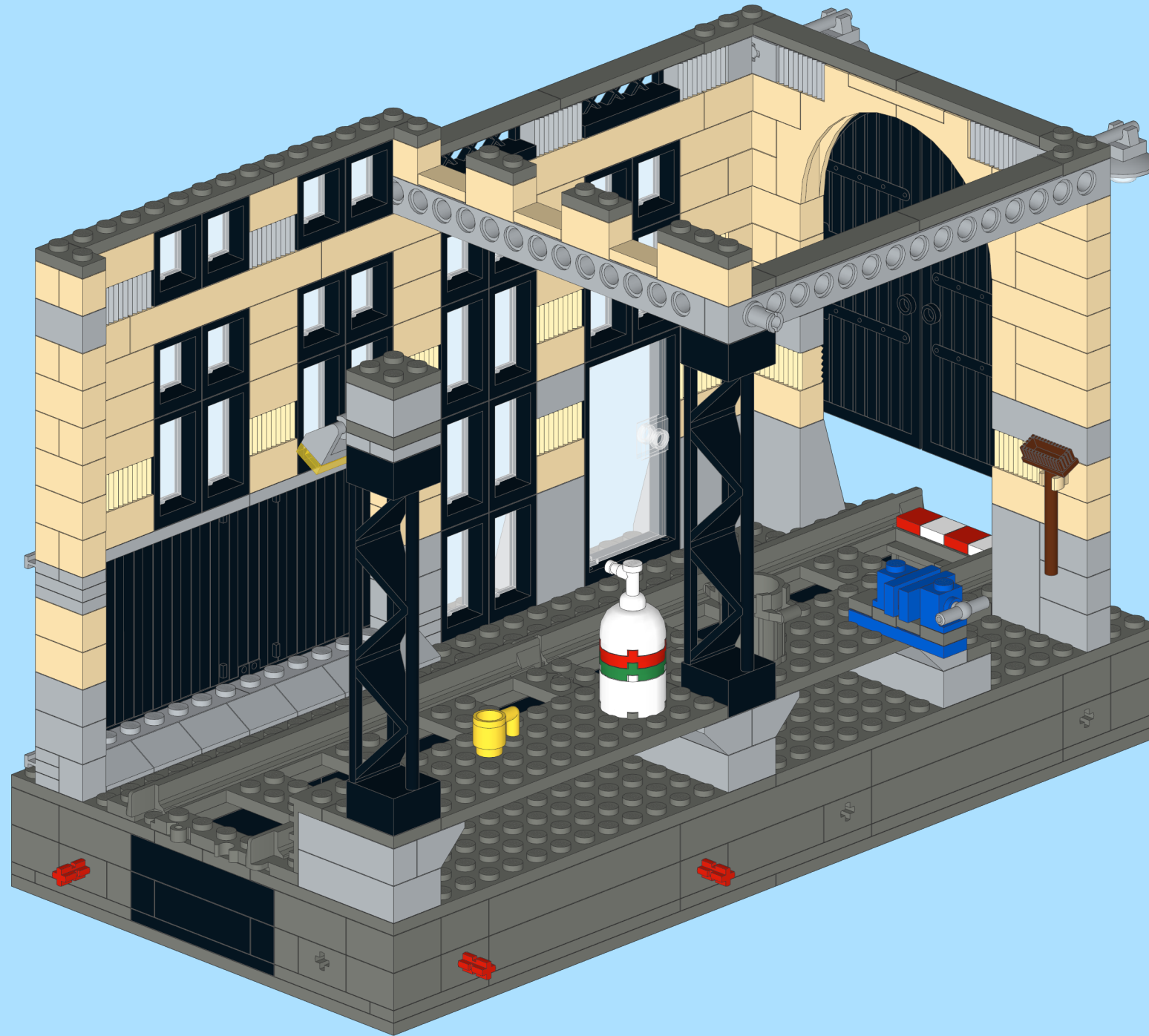
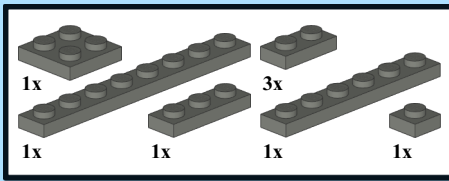

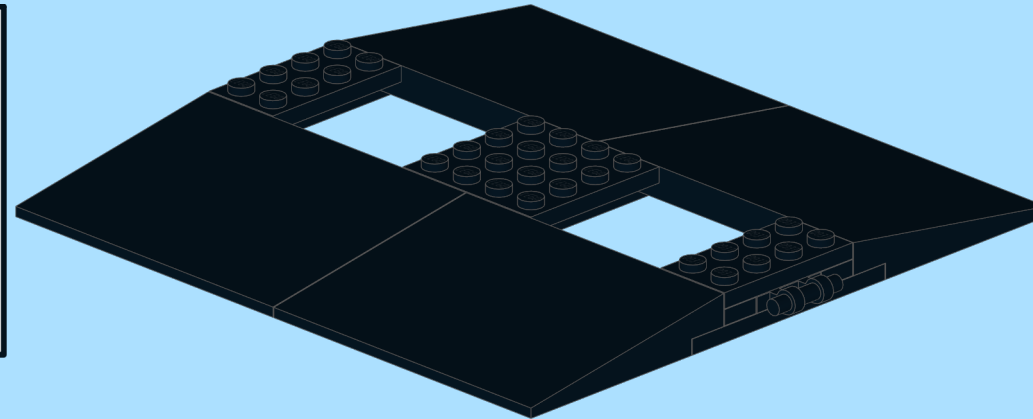
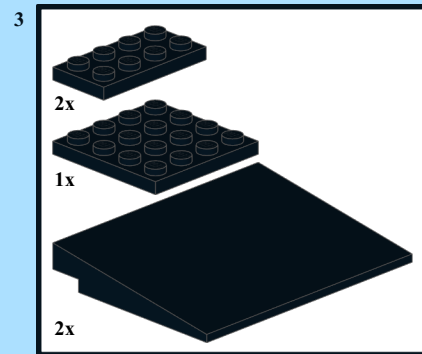
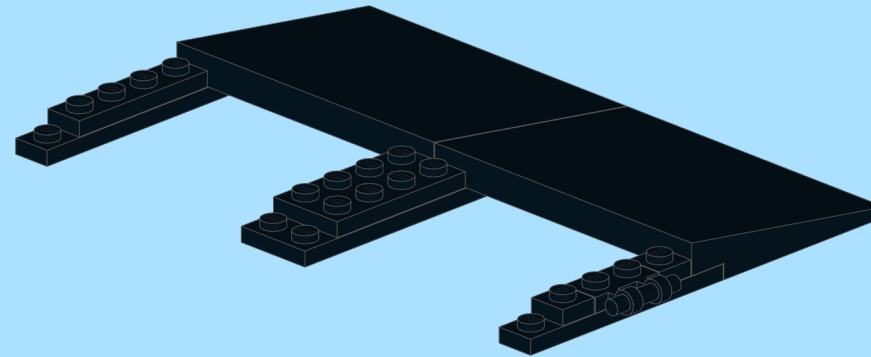
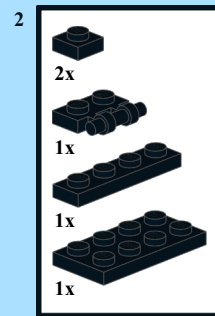
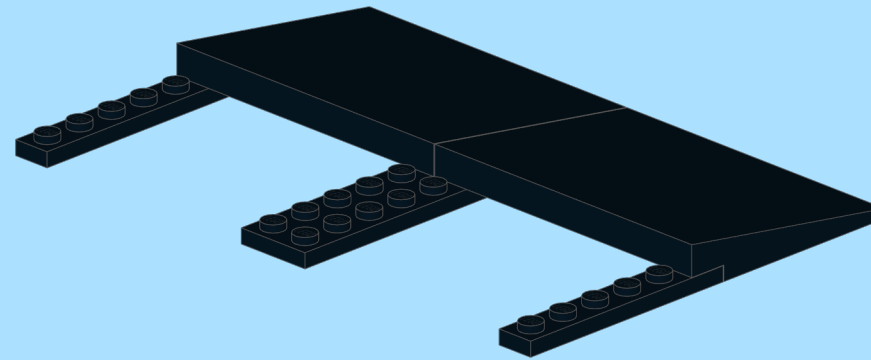
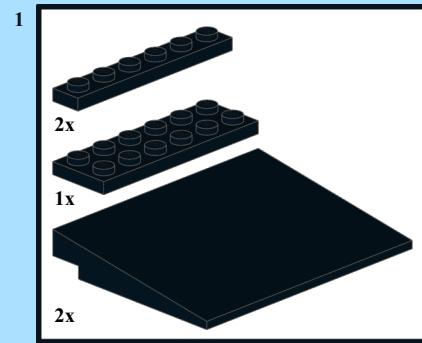

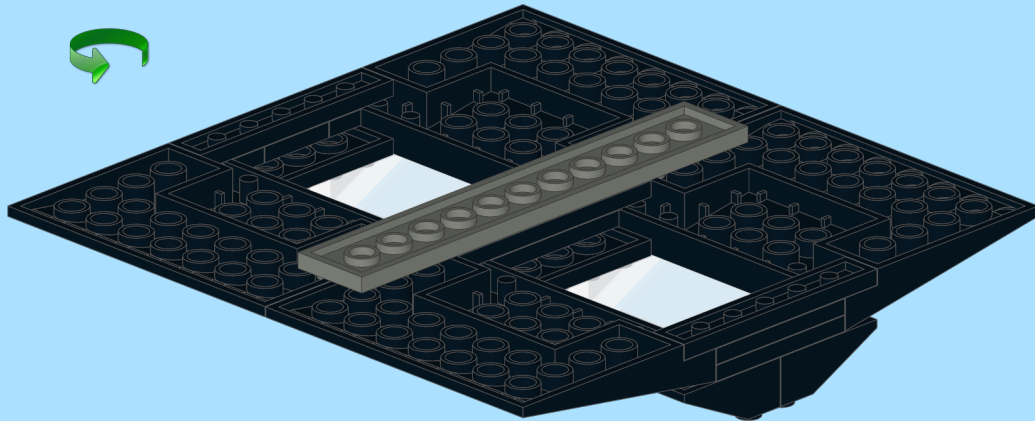
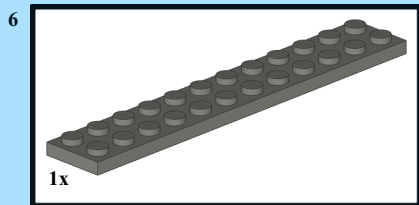
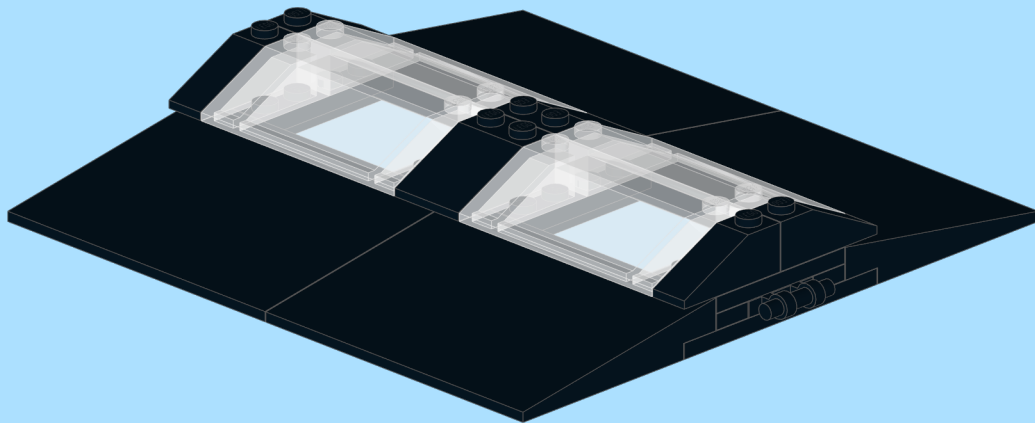
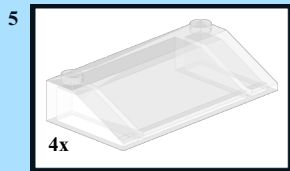
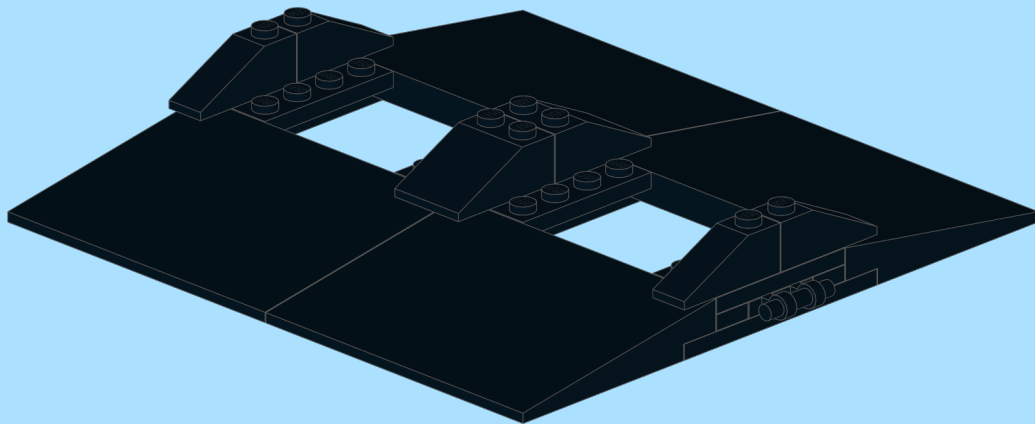
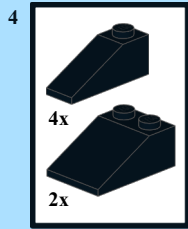

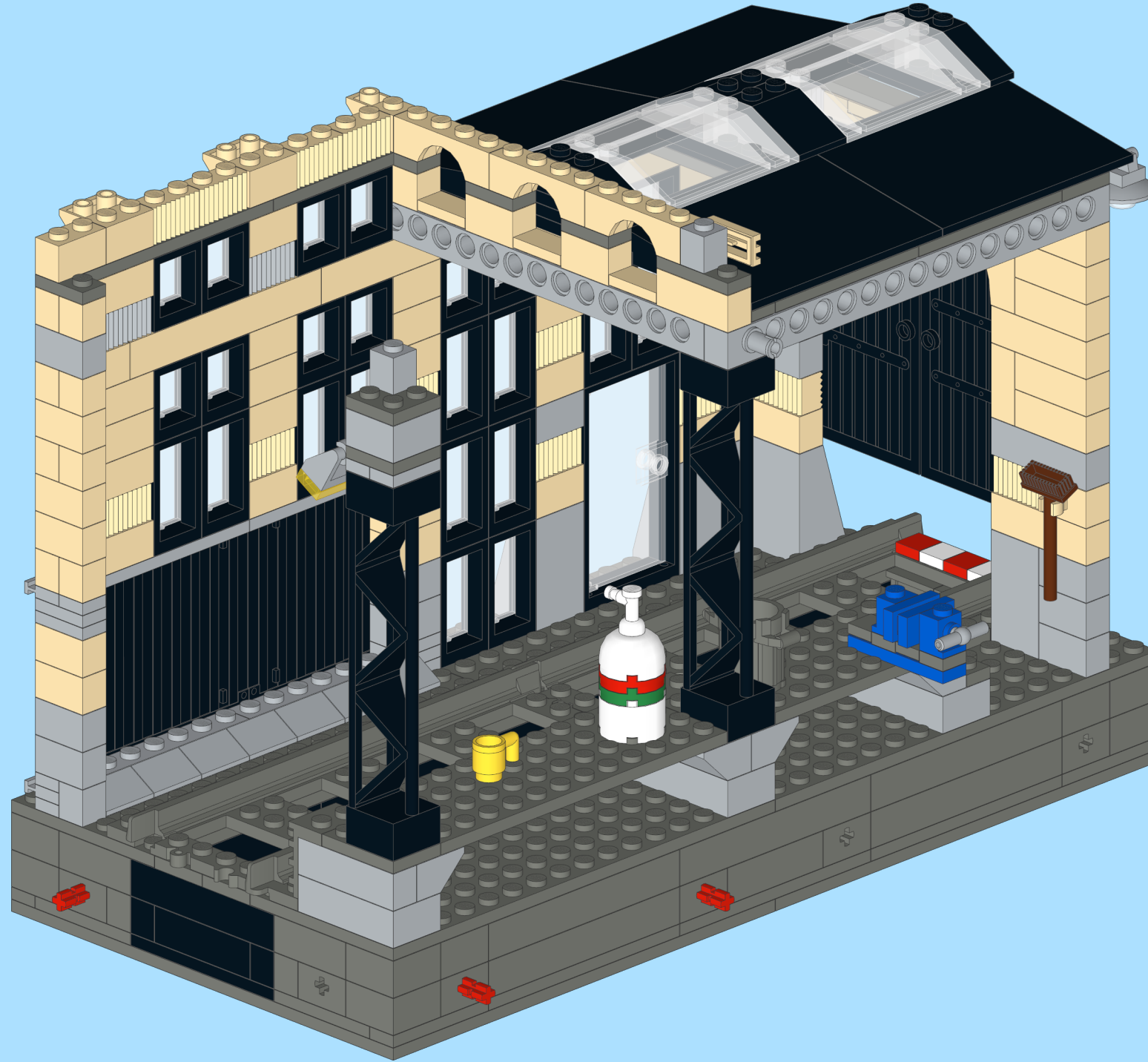
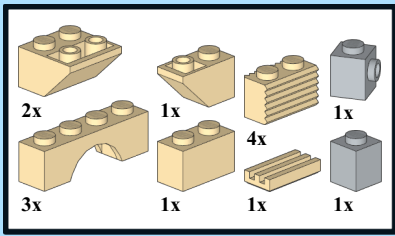

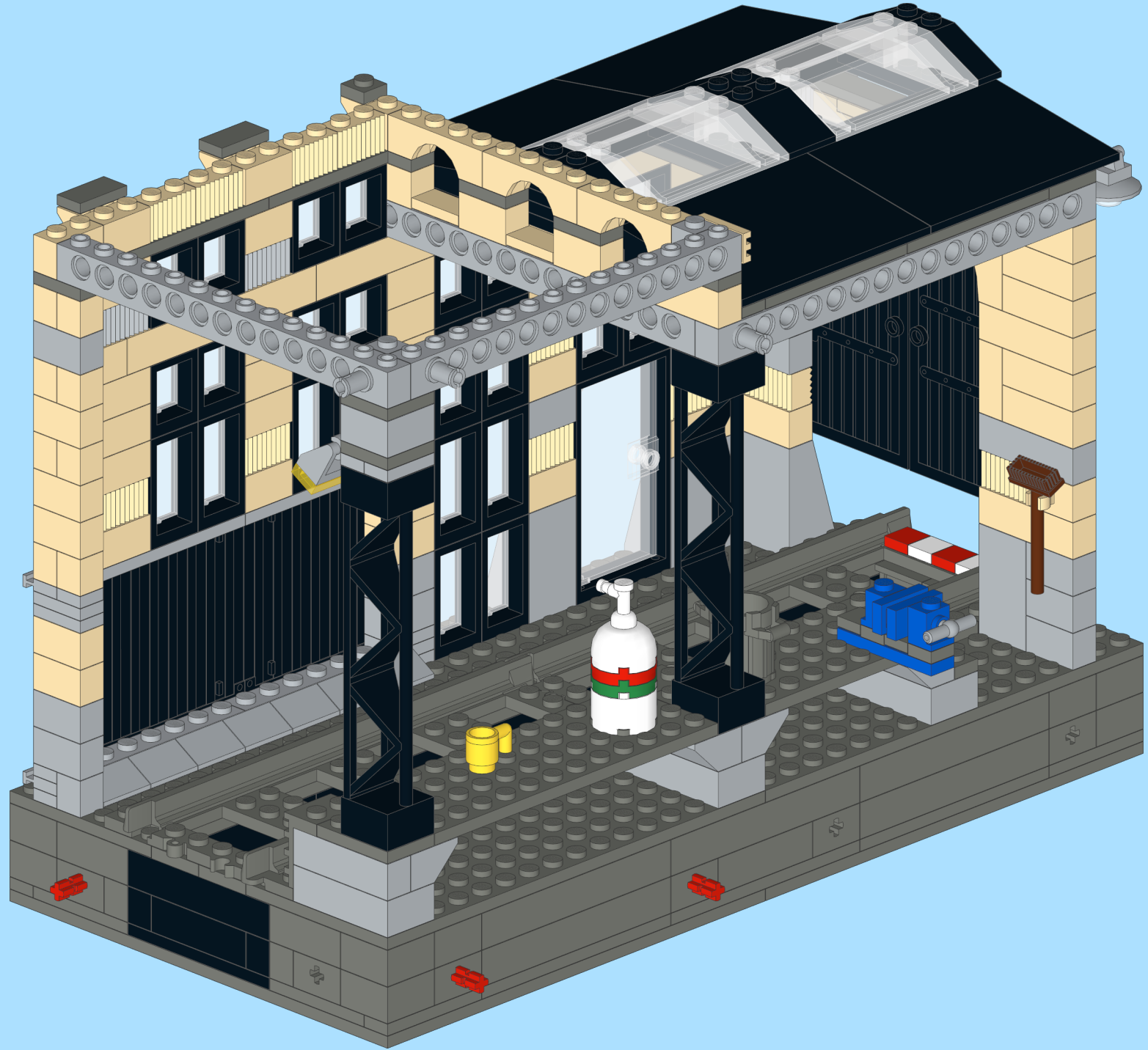
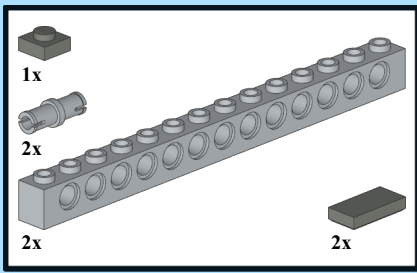

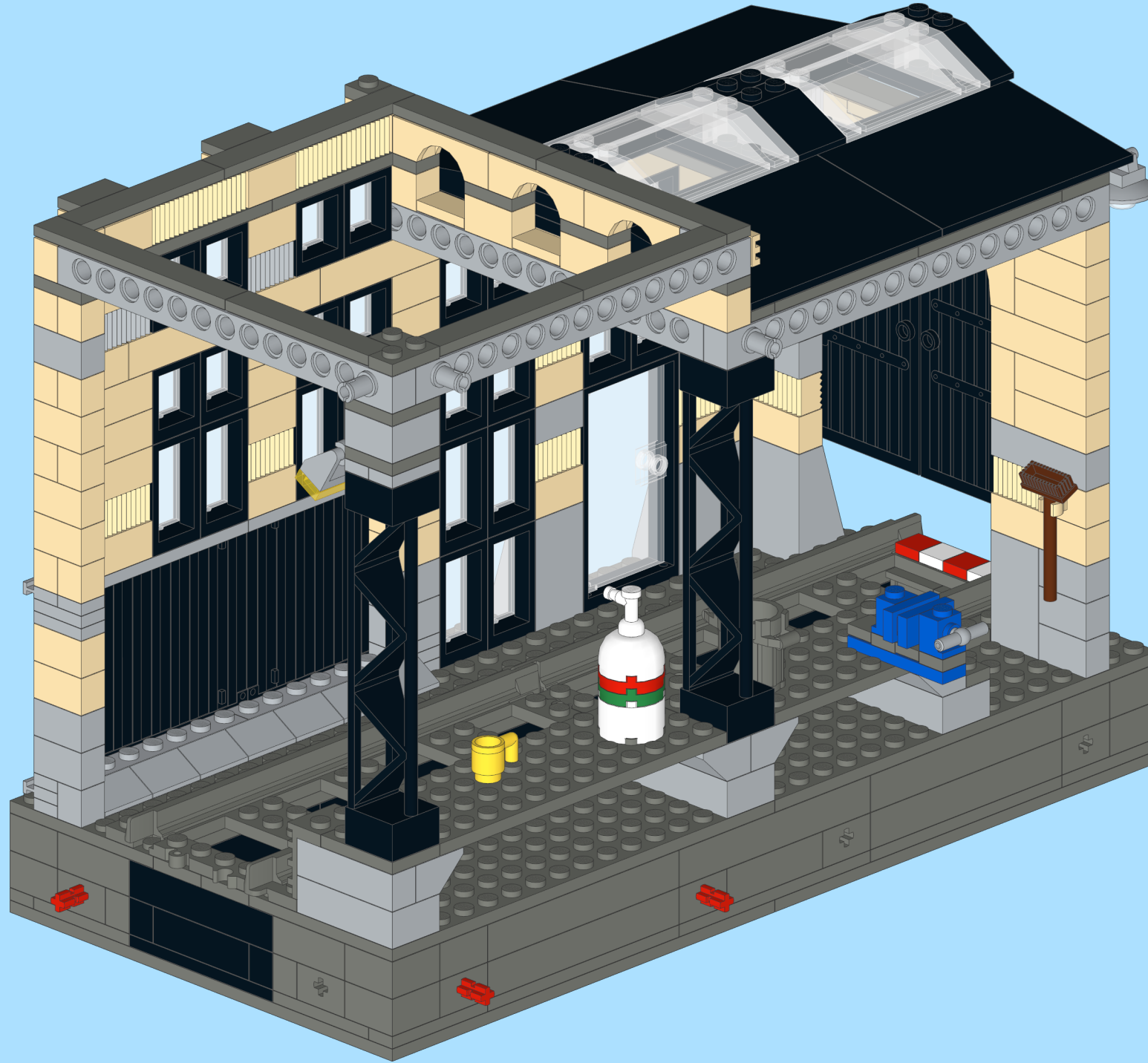
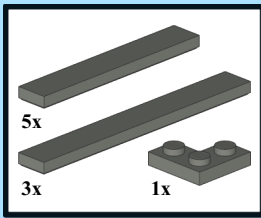

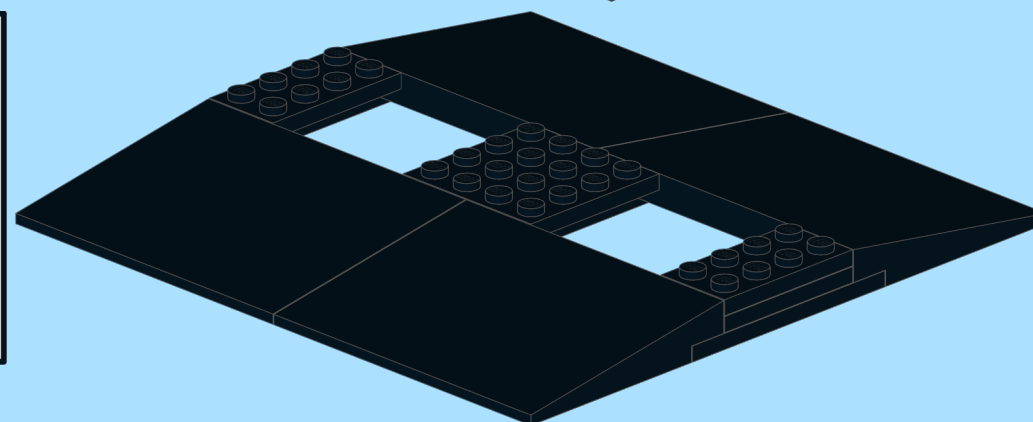
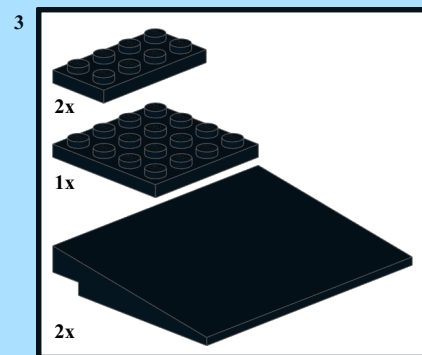
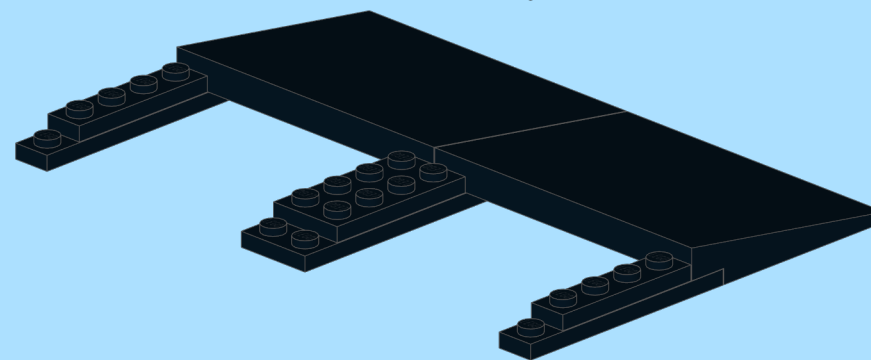
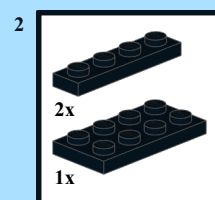
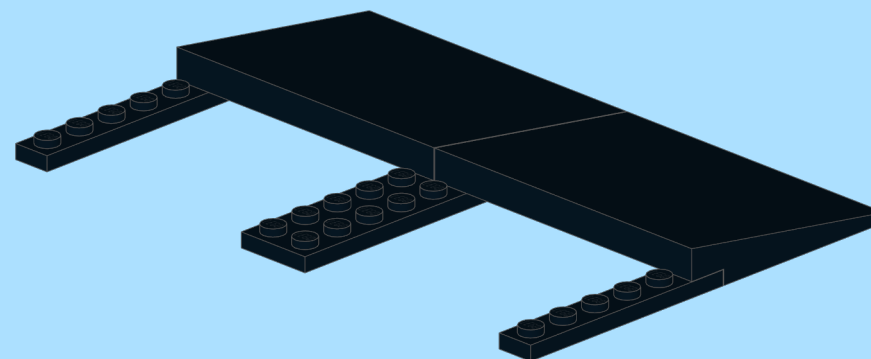
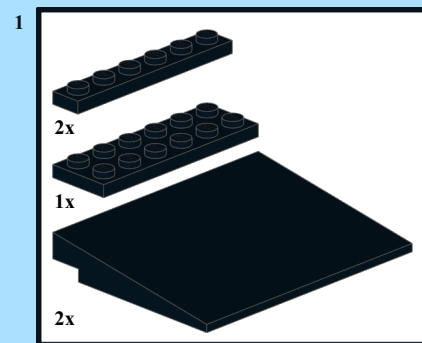

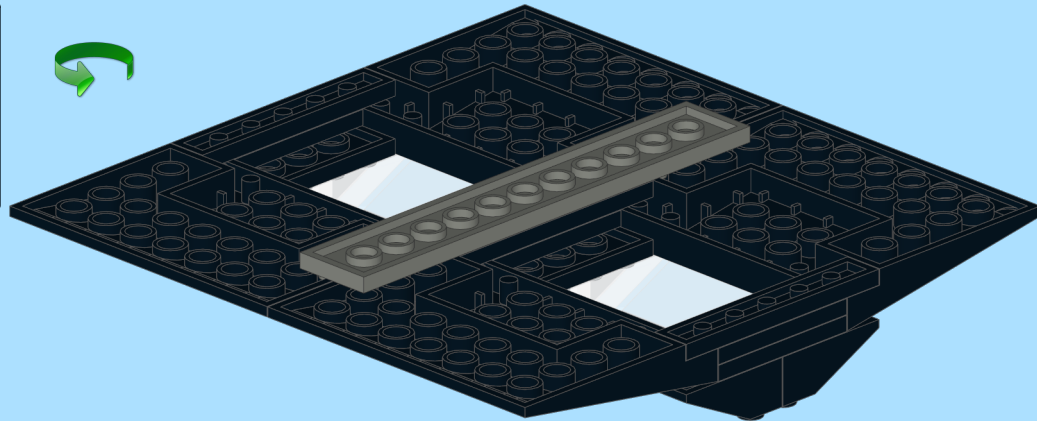
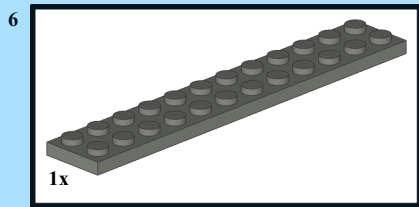
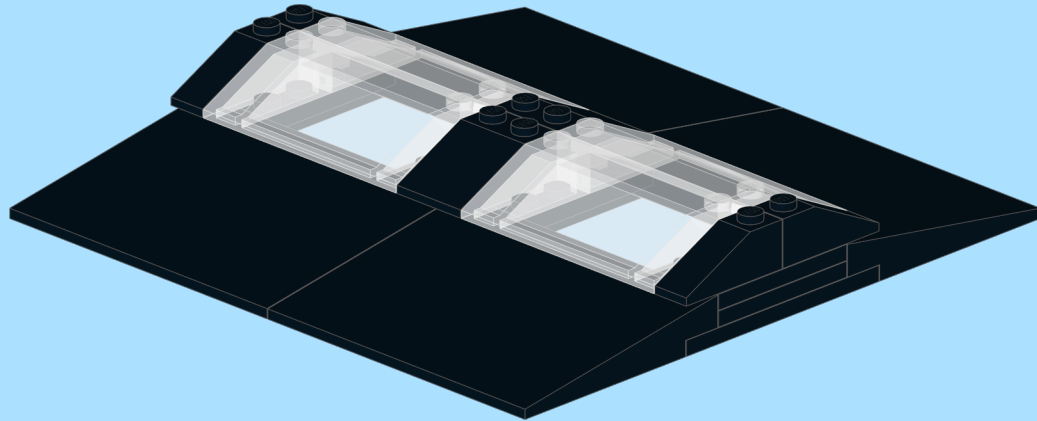
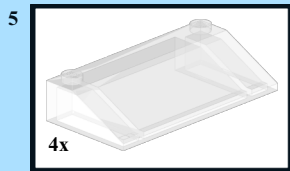
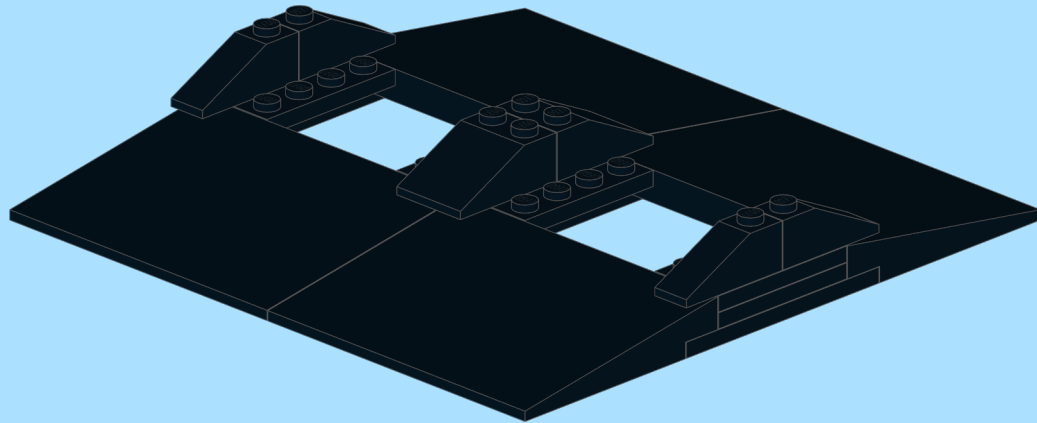
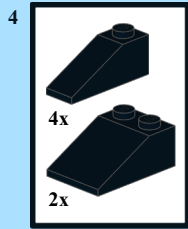

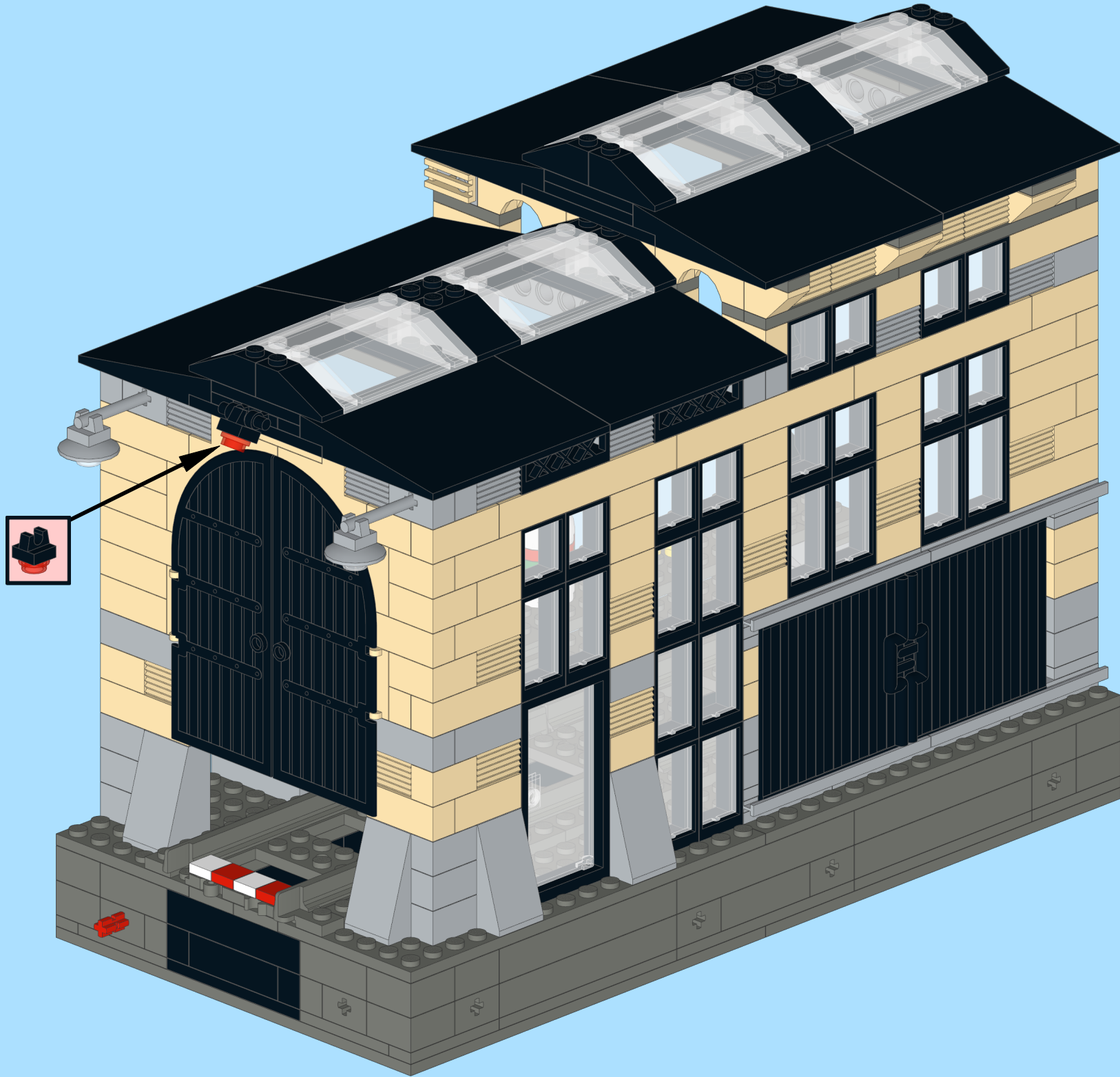
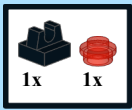

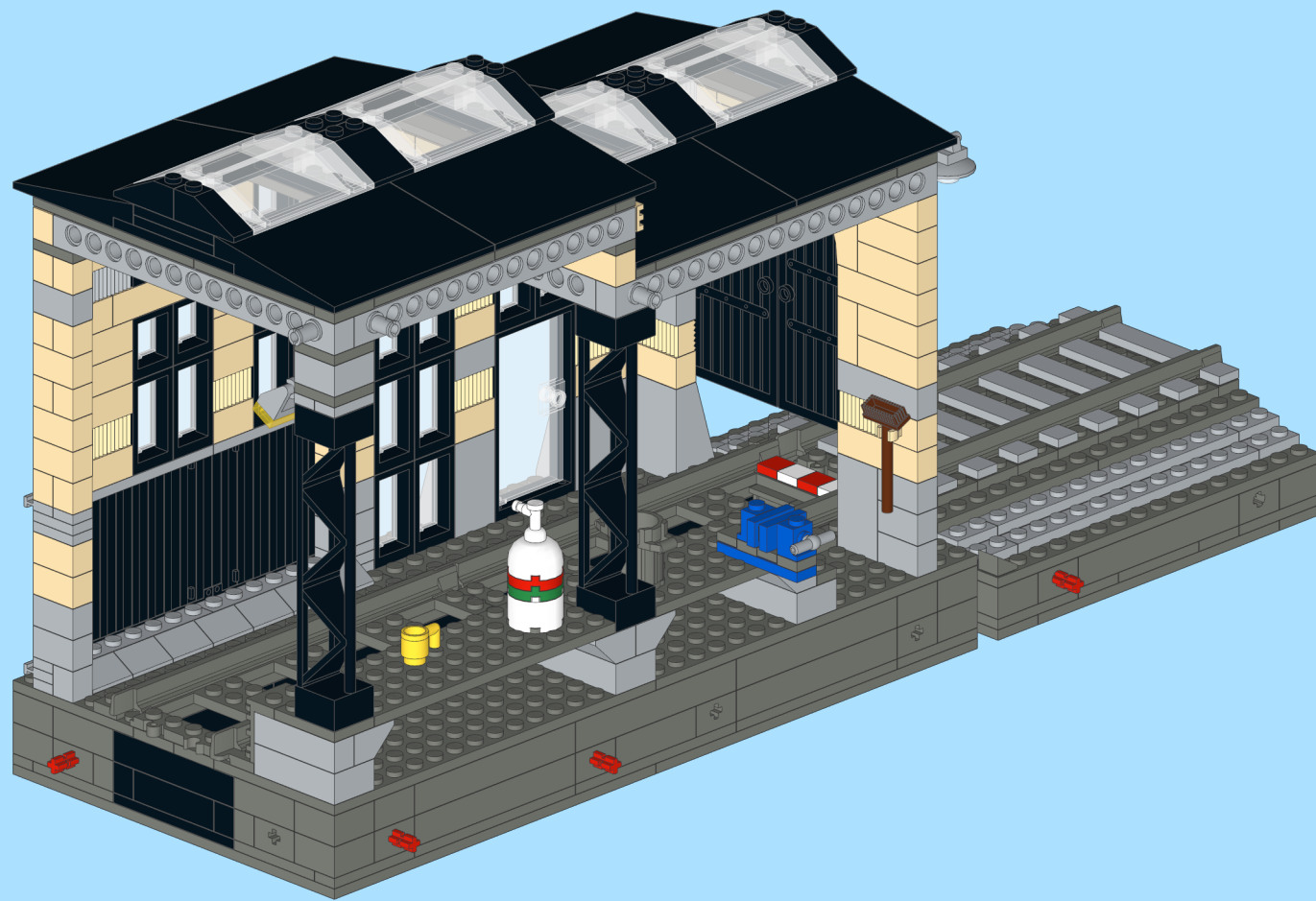

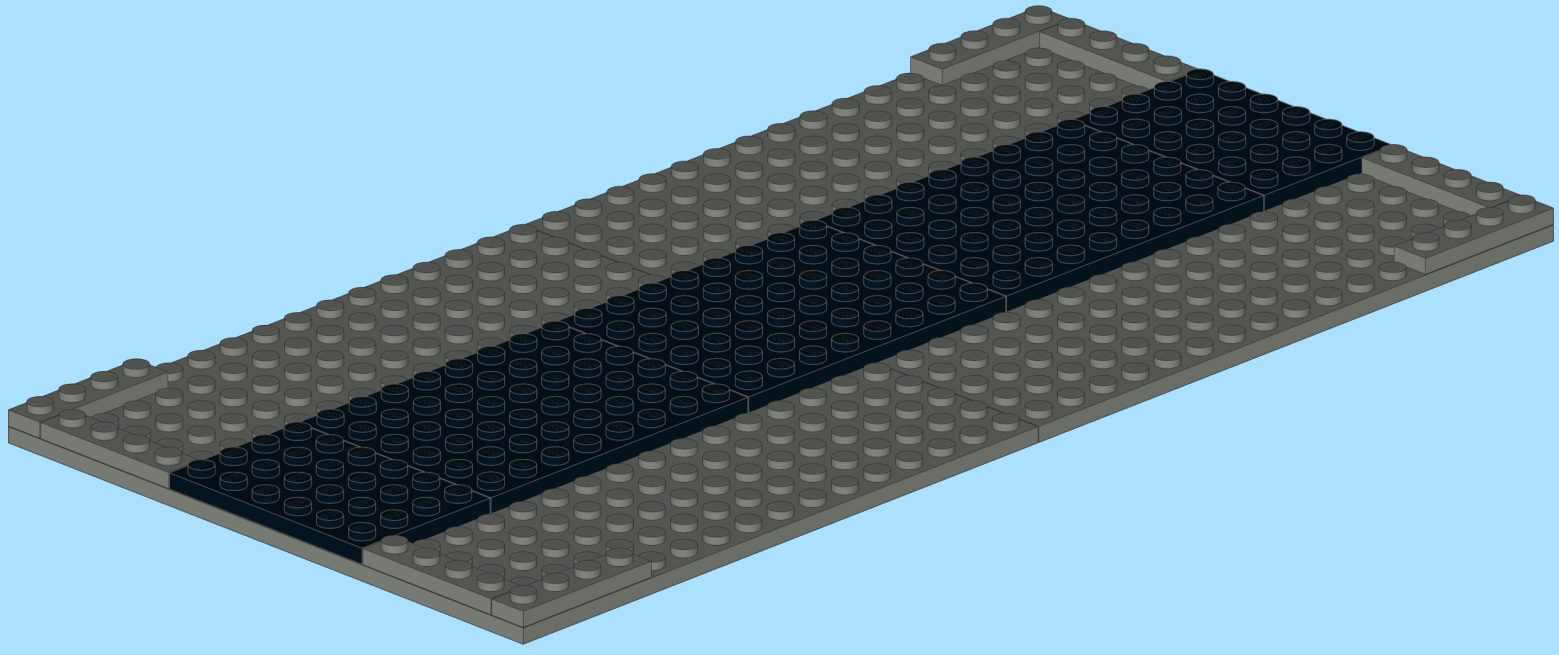
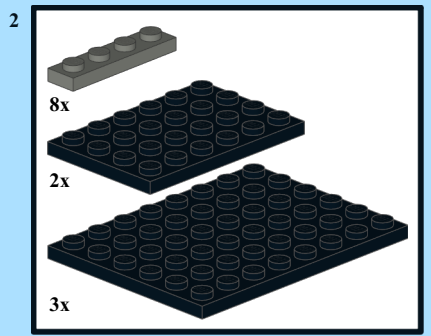
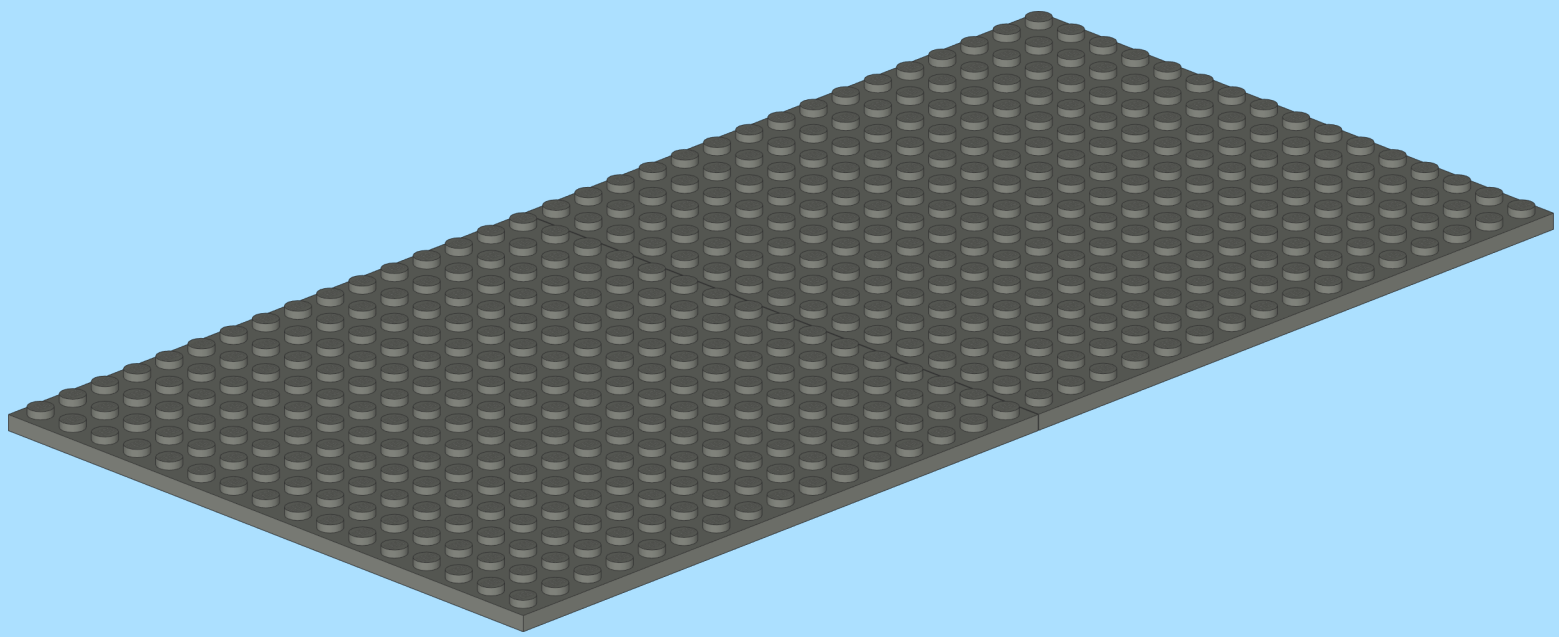
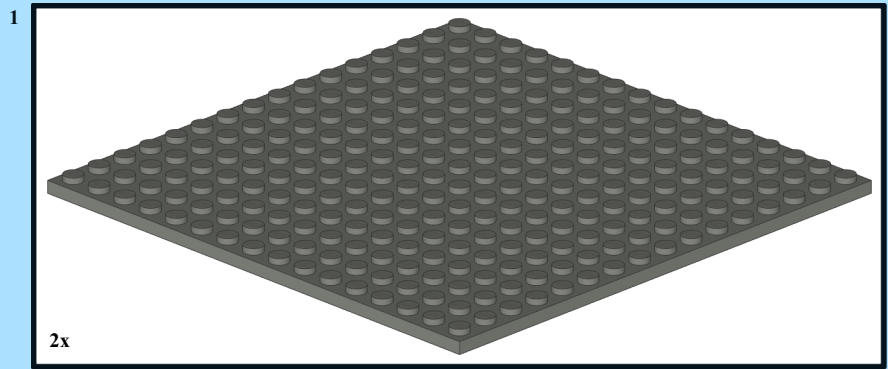

3

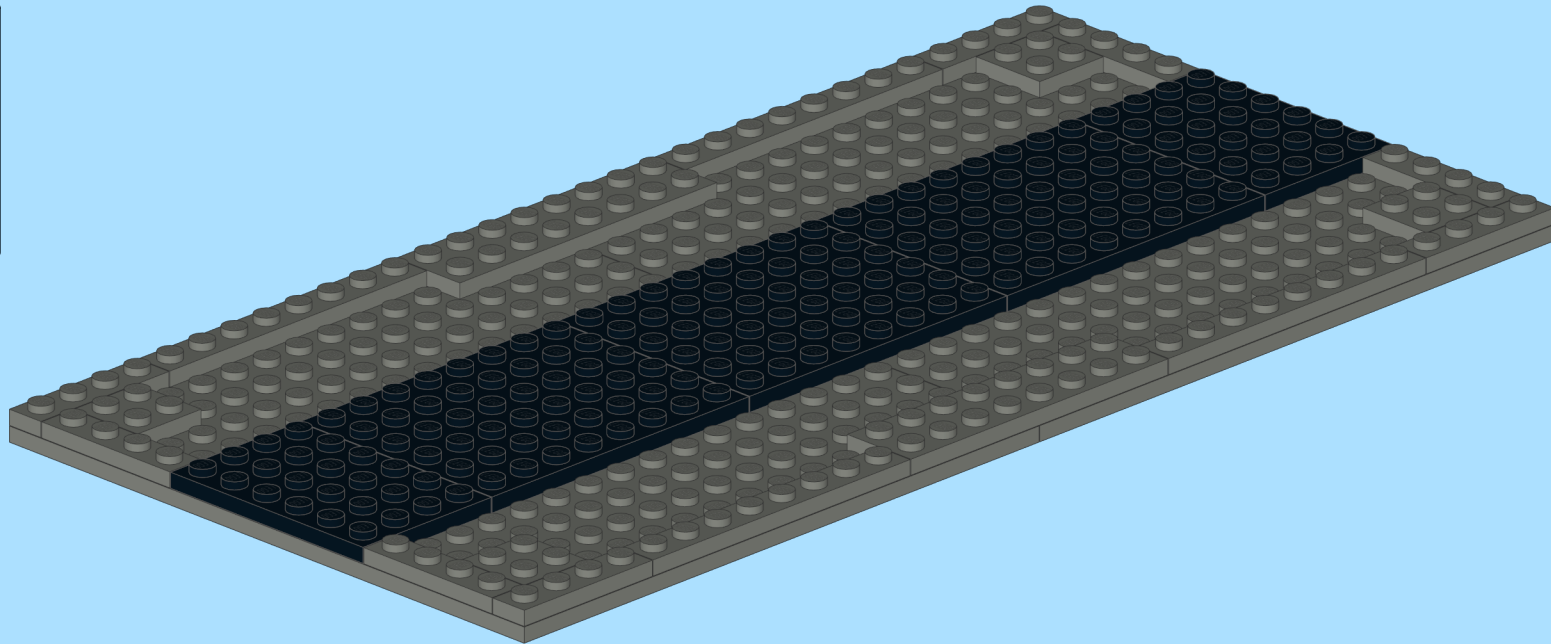
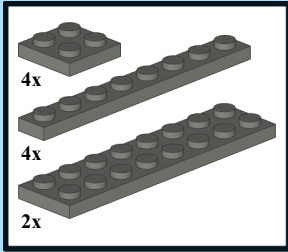

4

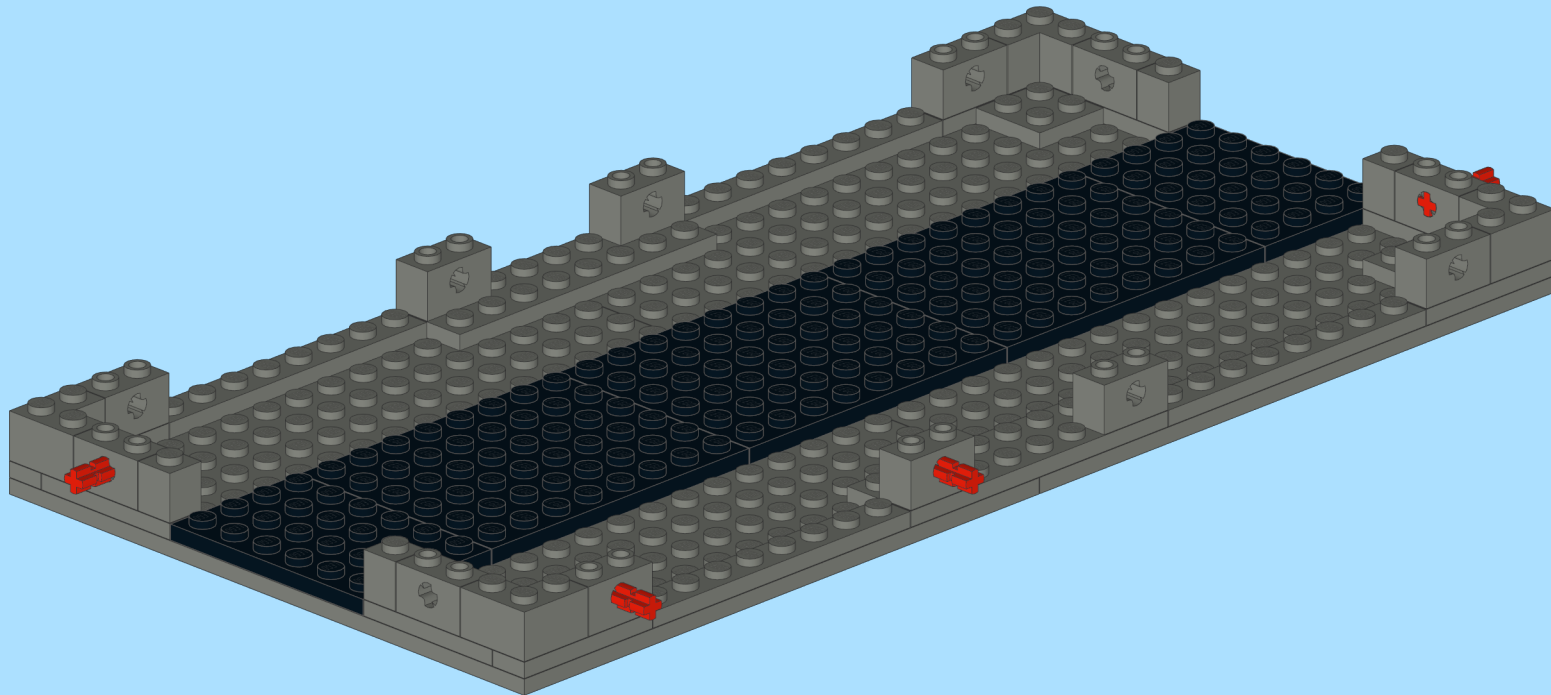
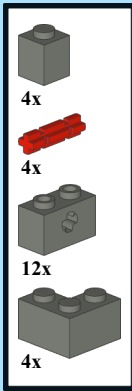

5

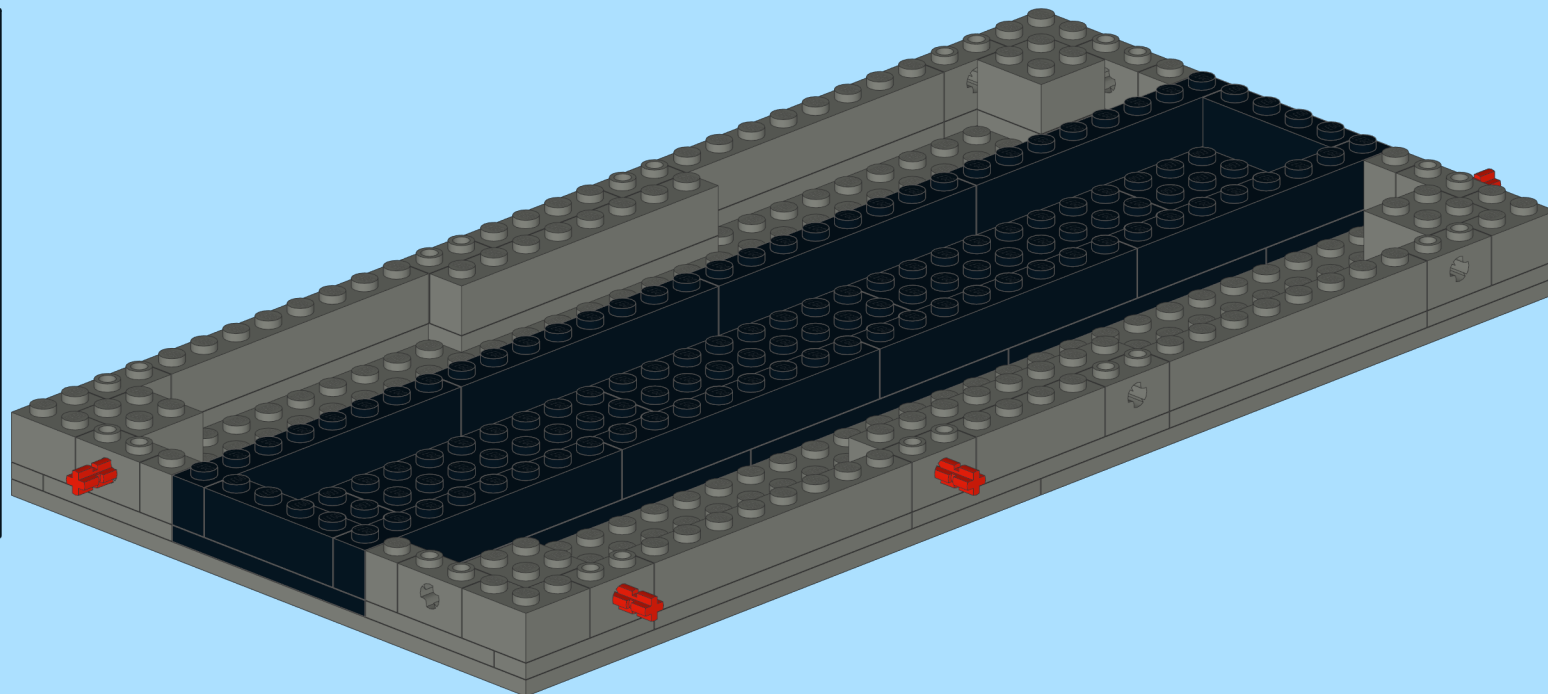
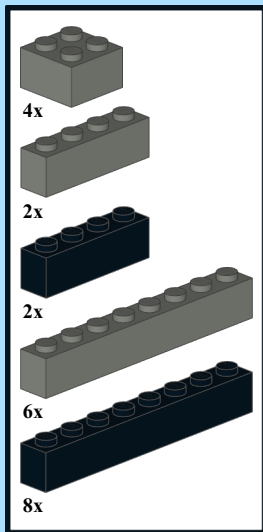

6

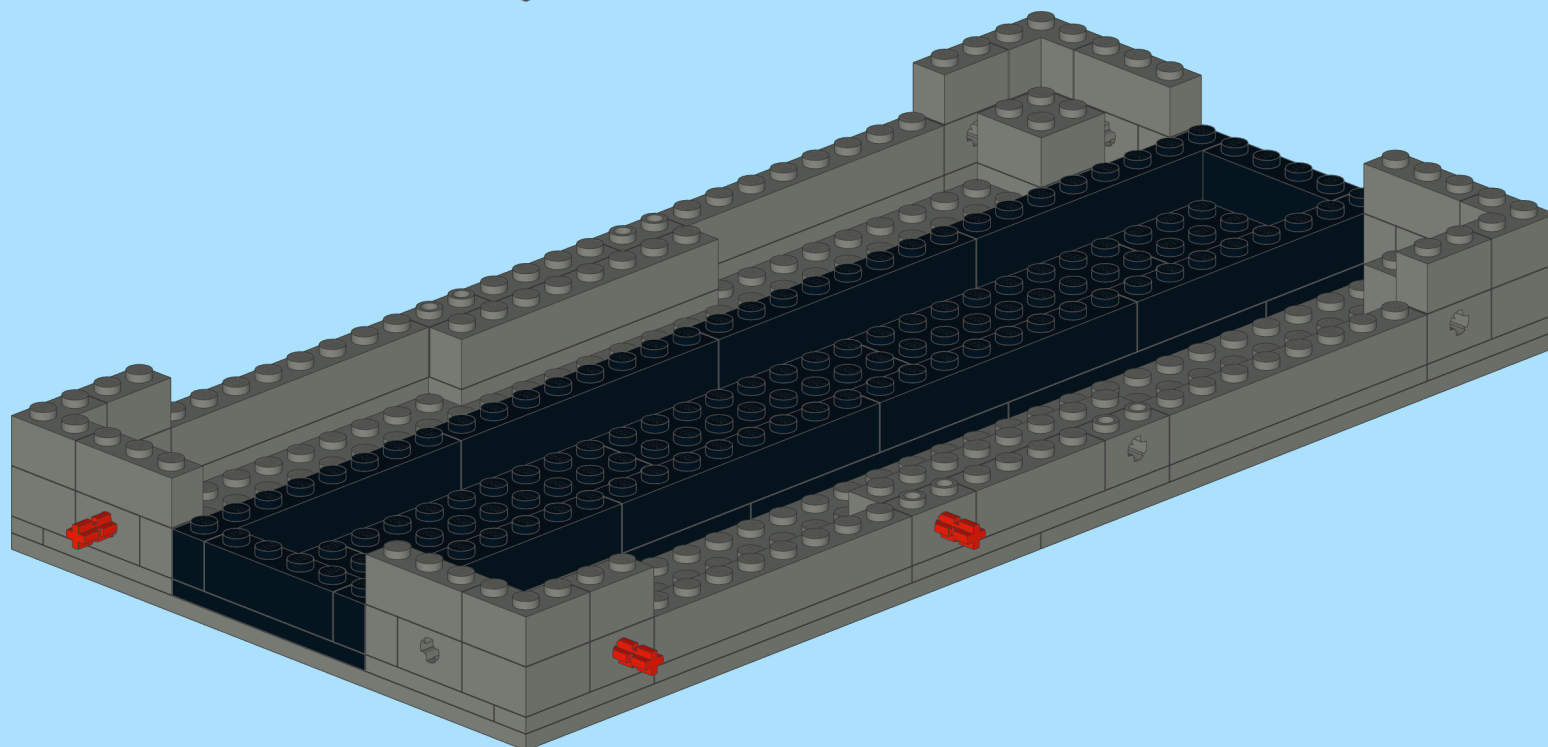
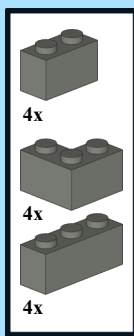

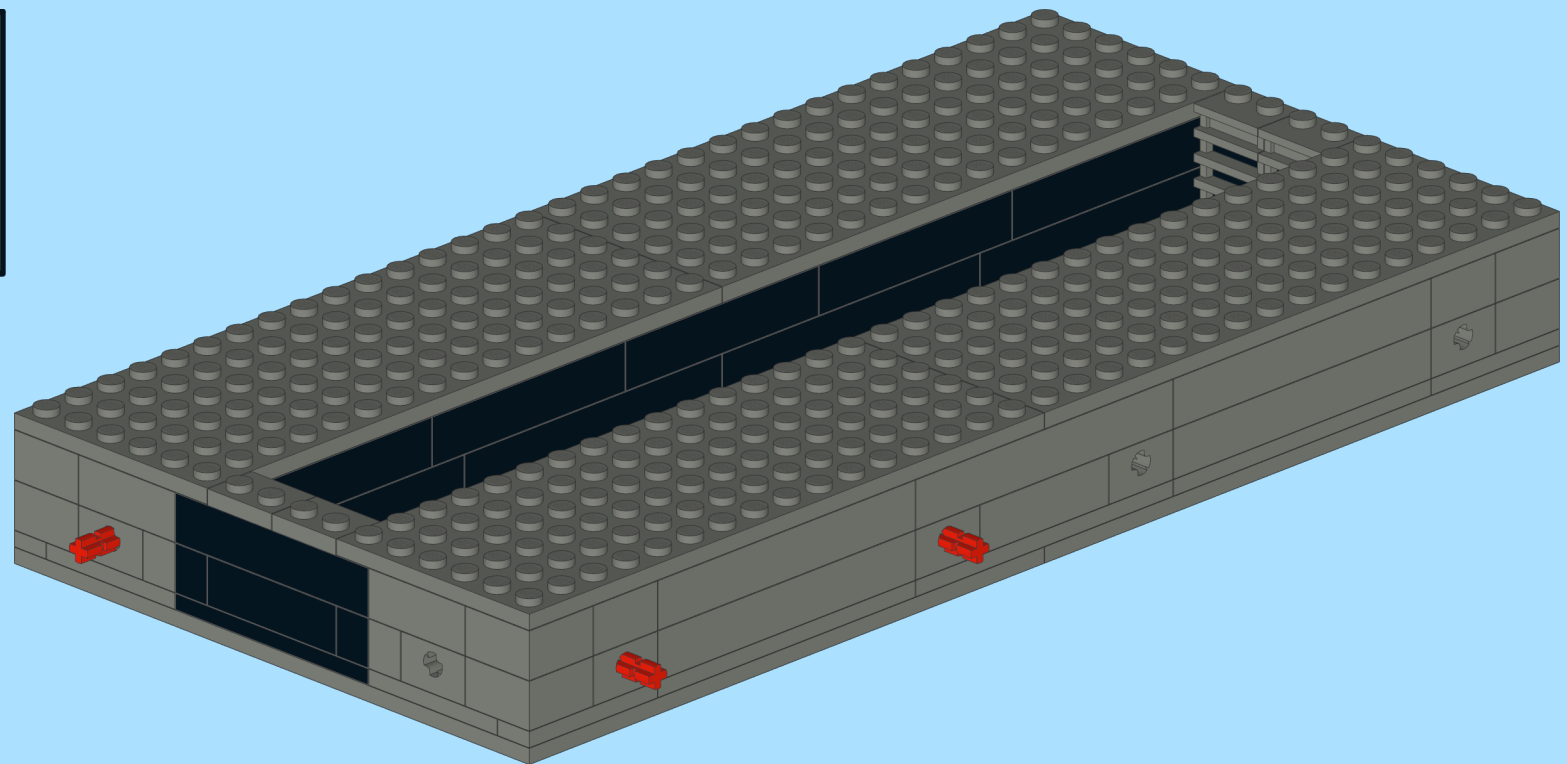
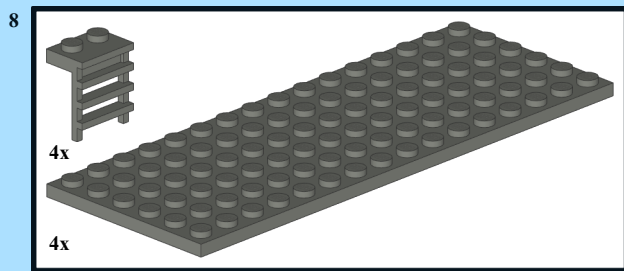
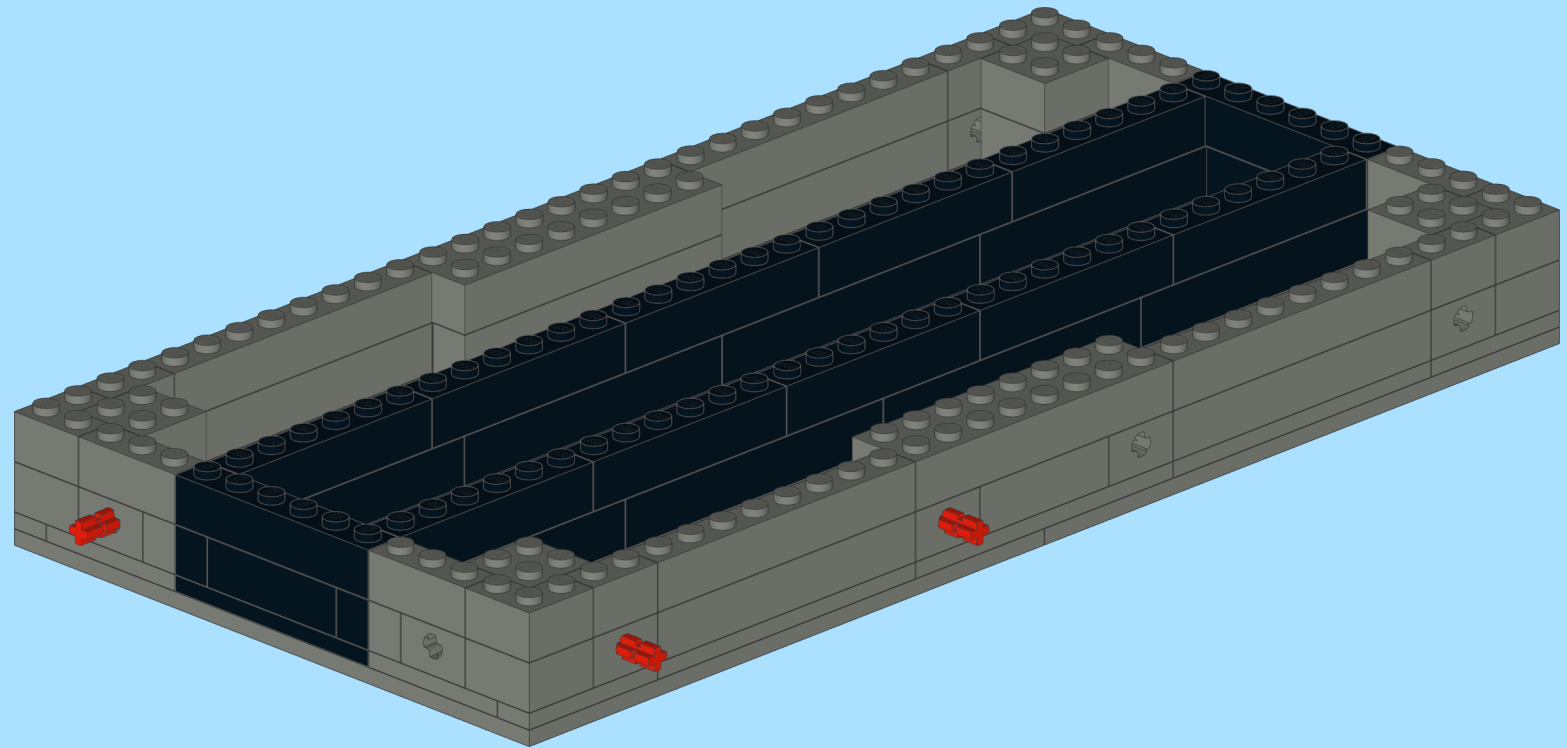
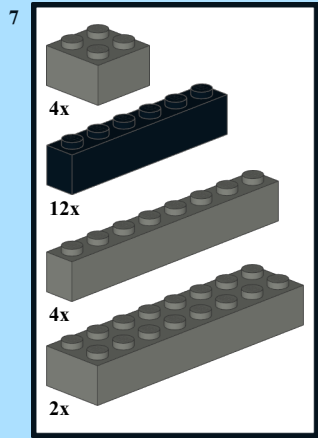

9

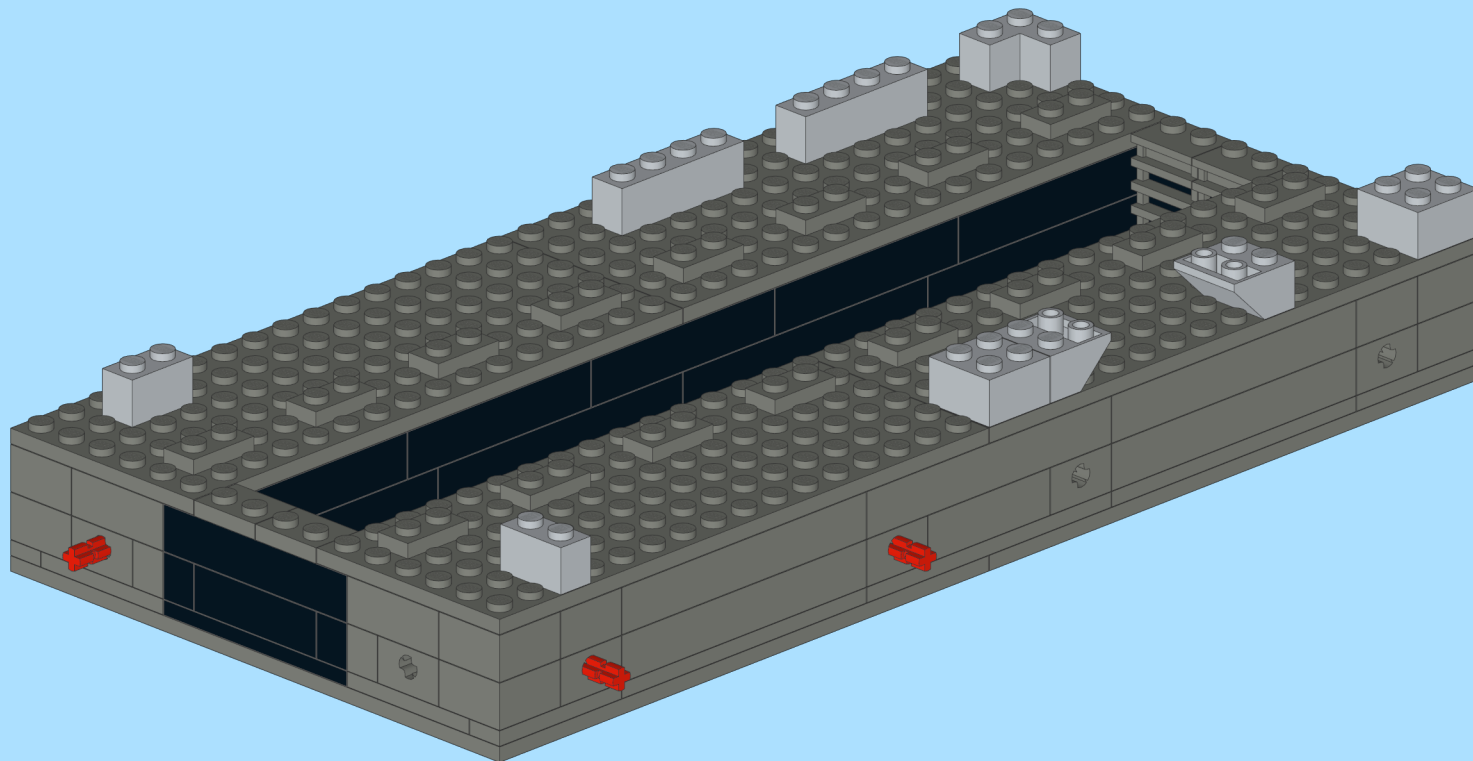
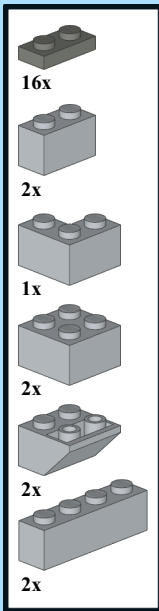

10

