

Train Track Train Mounter

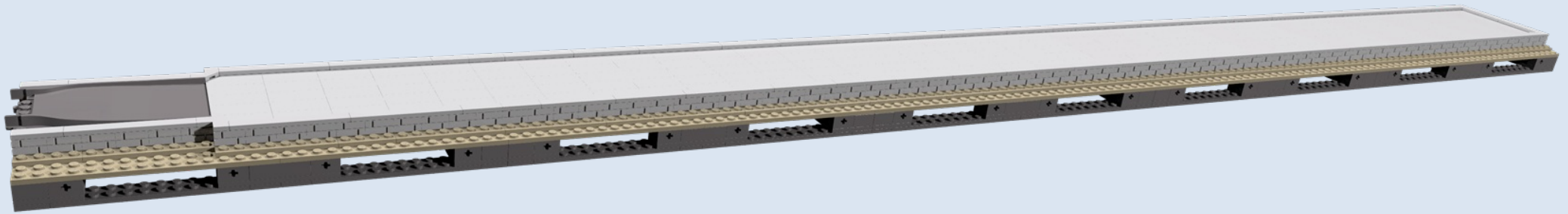

1

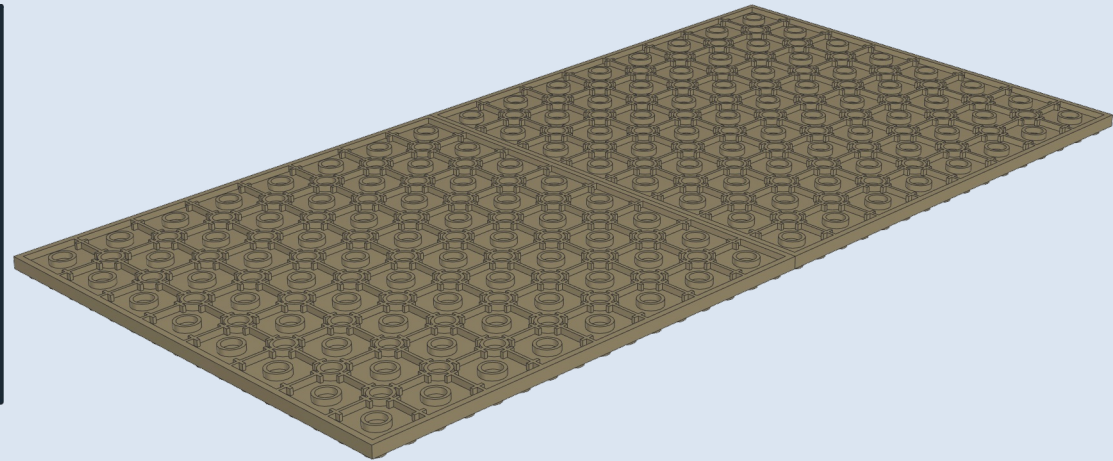
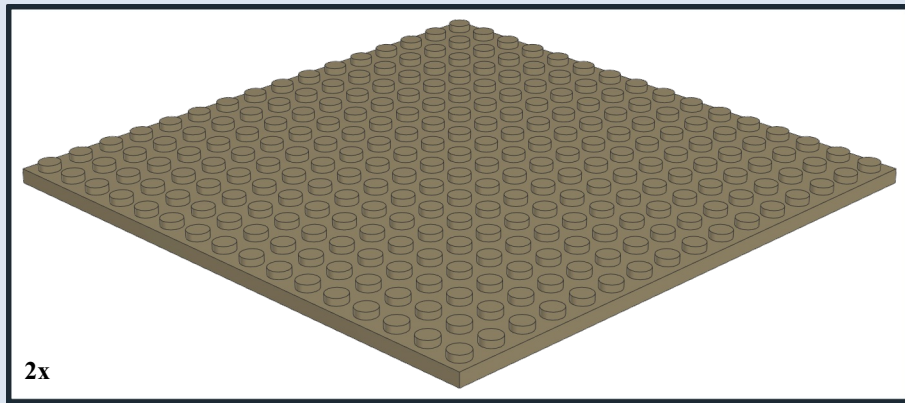

2

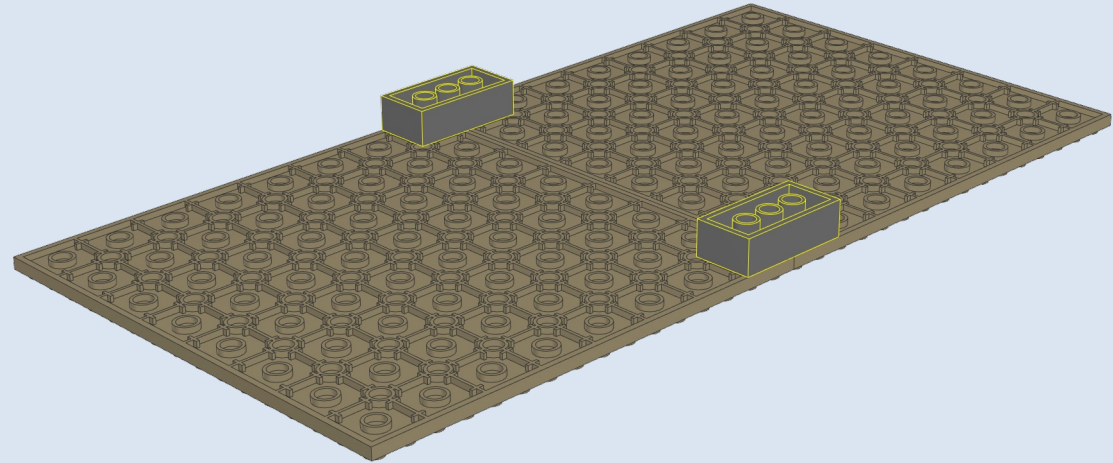
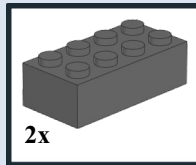

- 3
- 12x
 - 4x

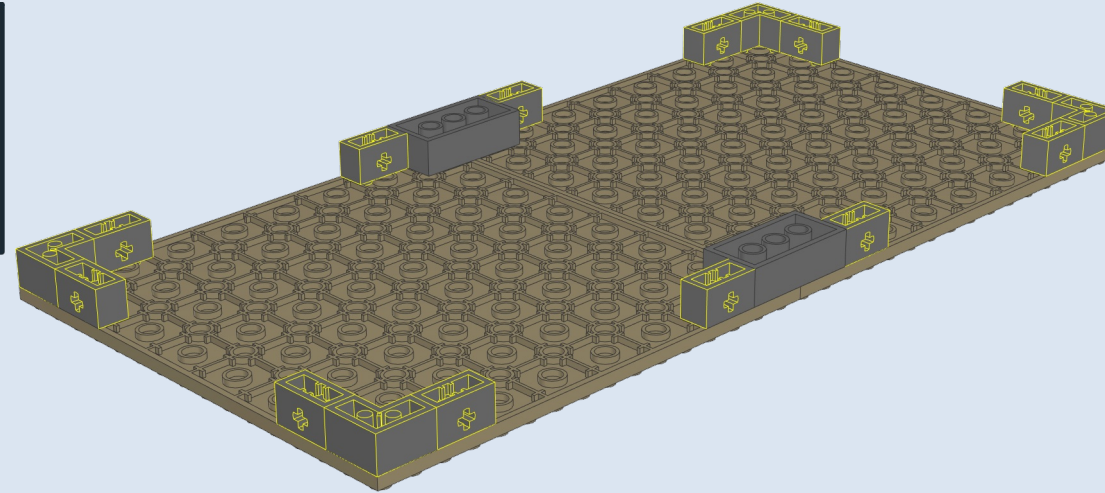

- 4
- 5x
 - 4x

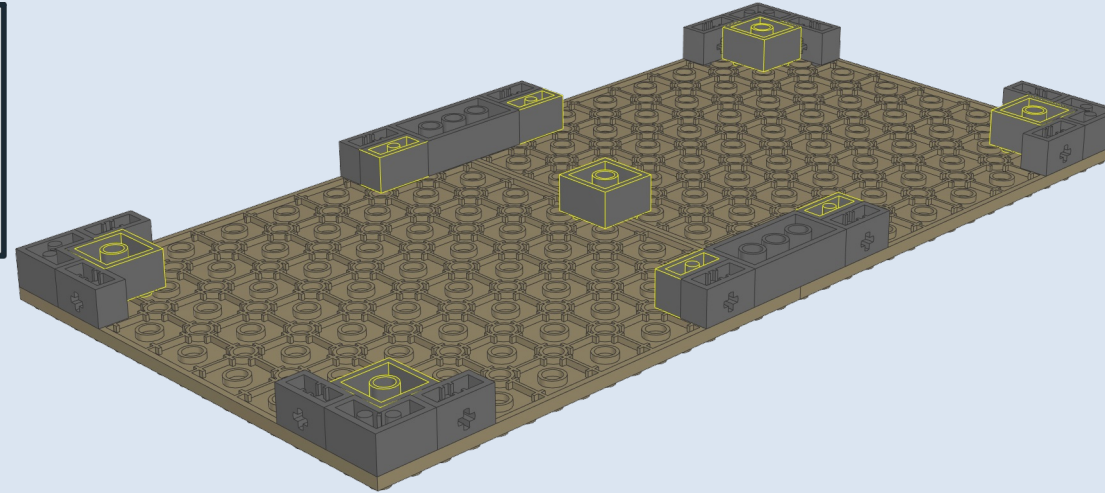

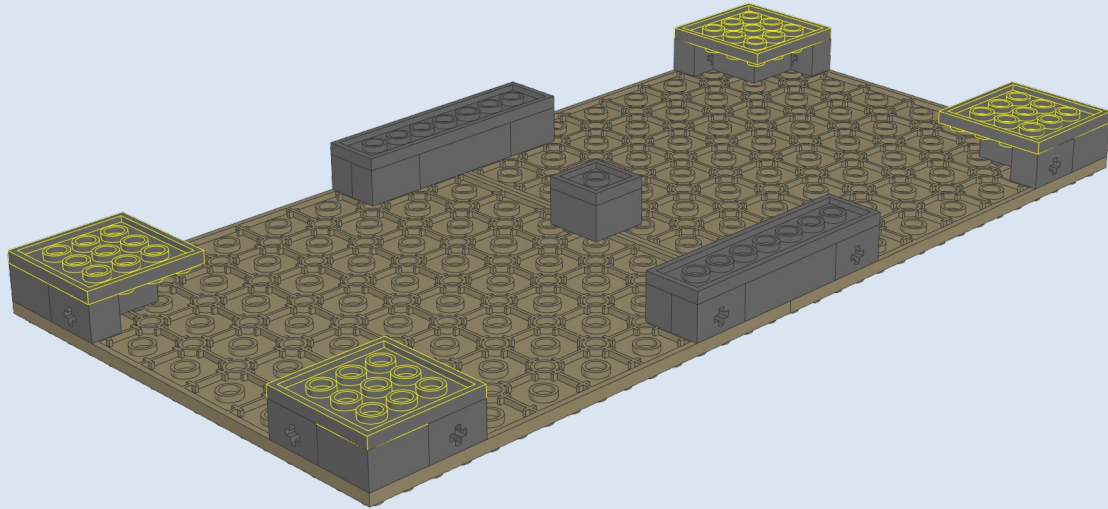
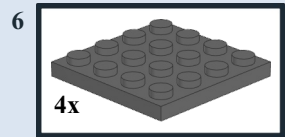
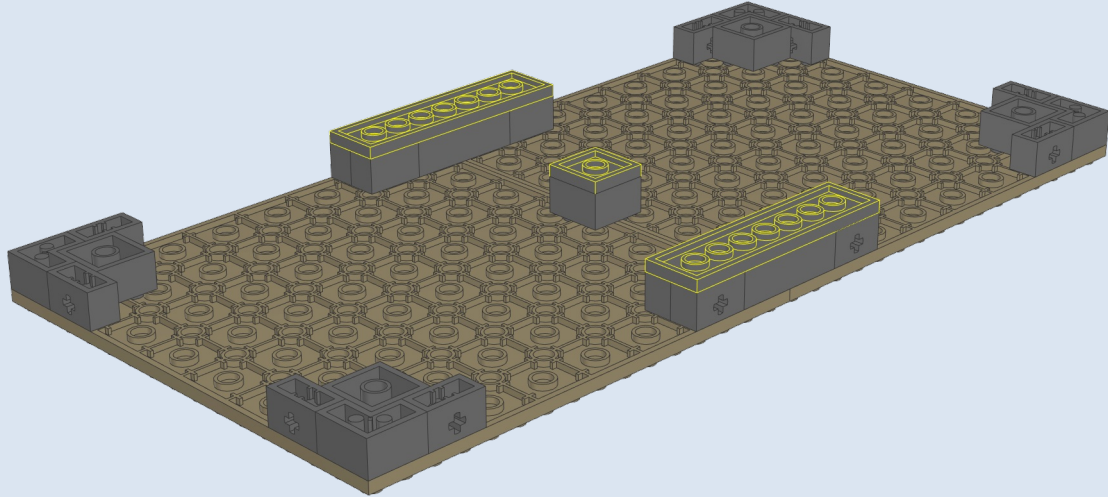
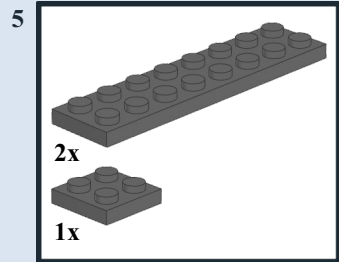

7

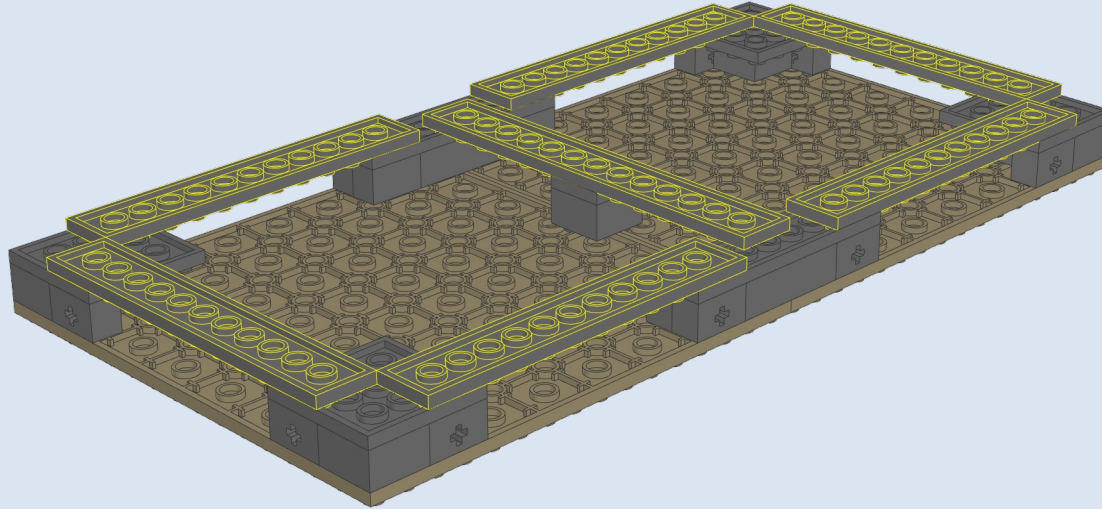
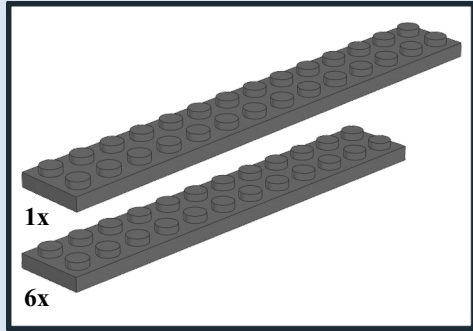

8

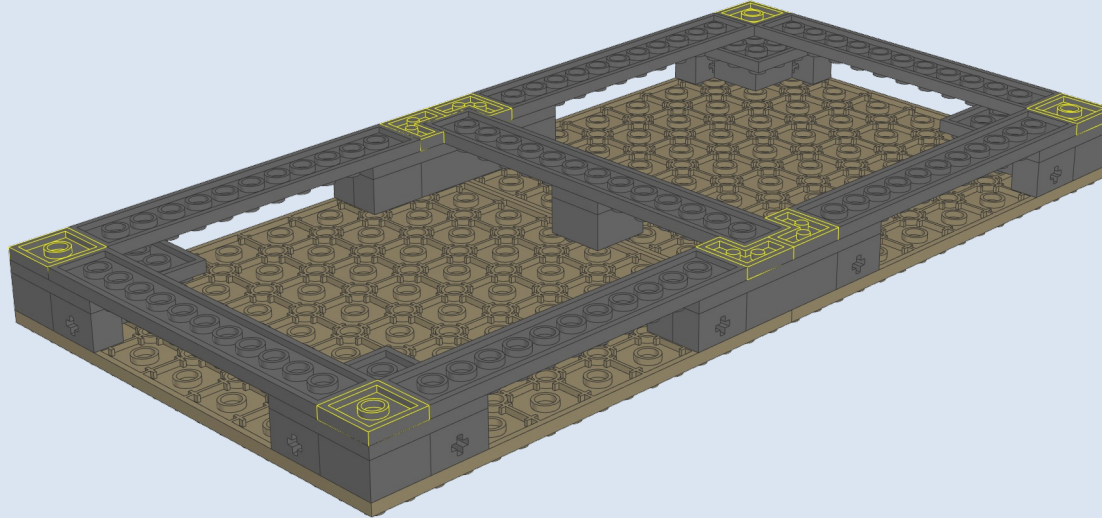
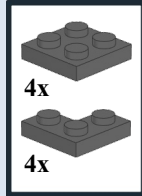

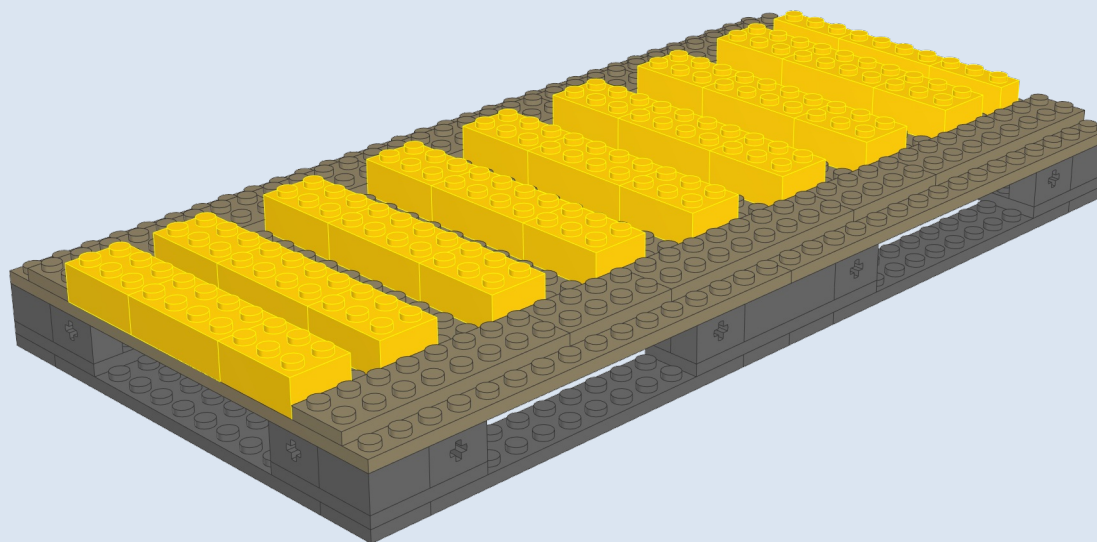
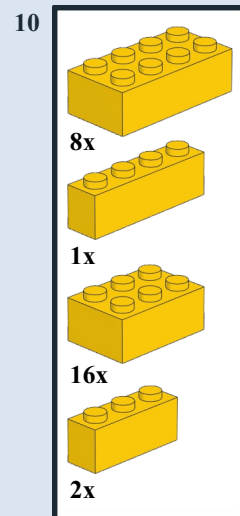
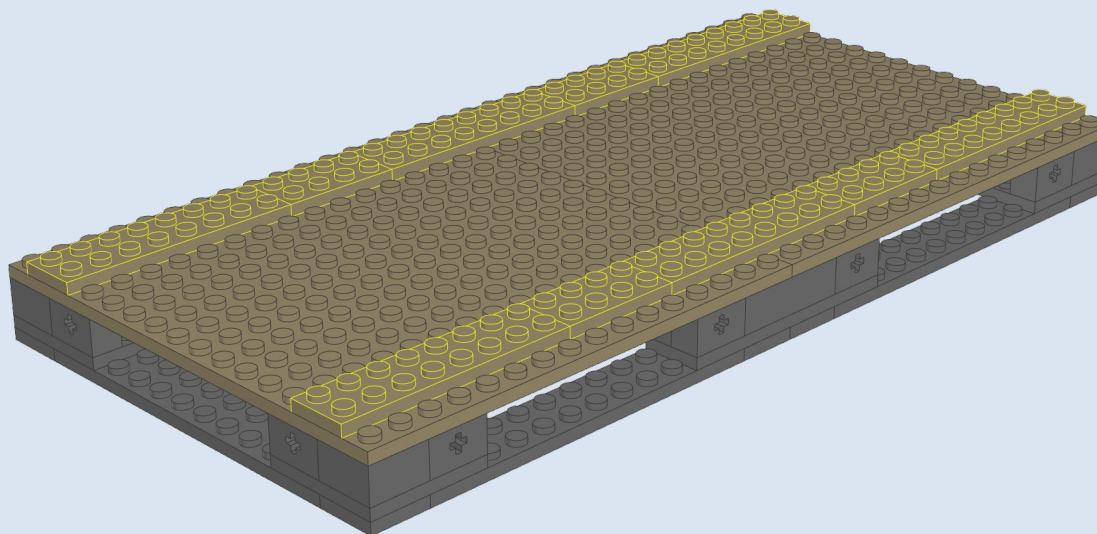
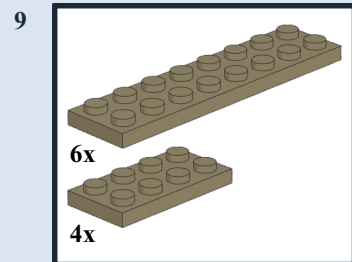

11

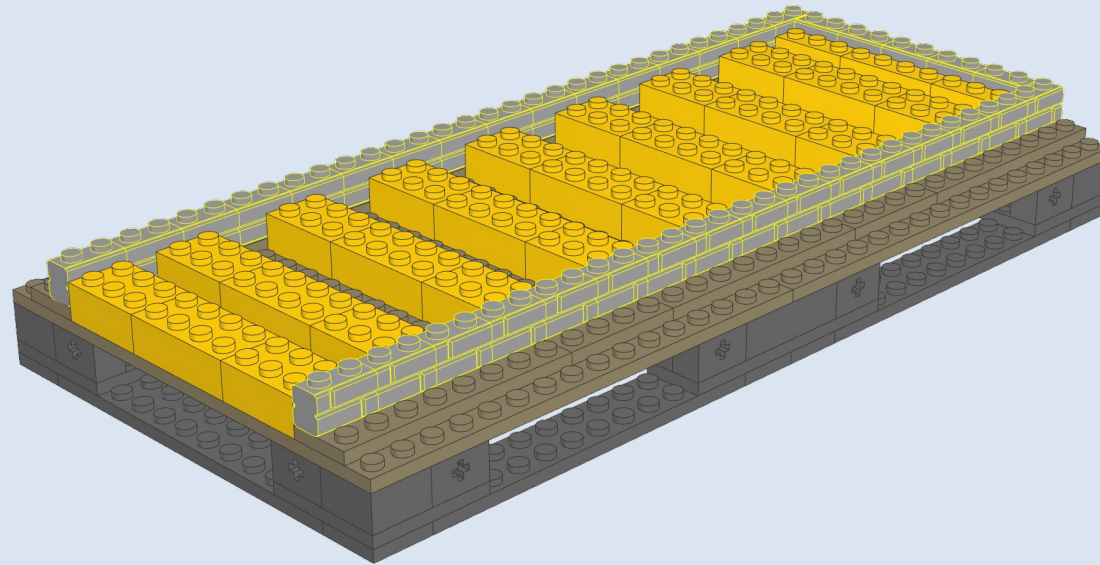
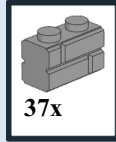

12

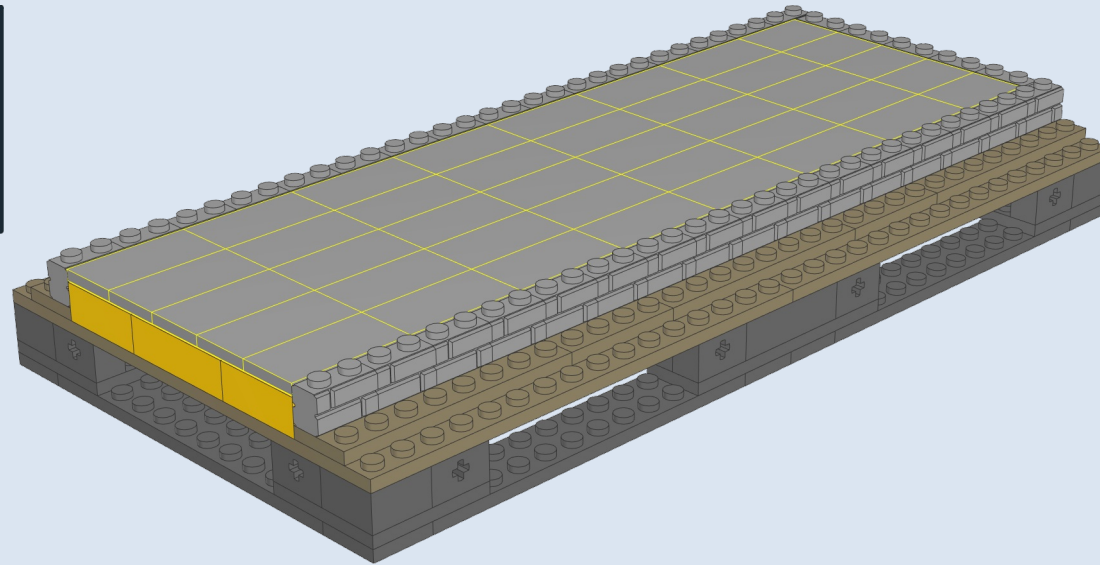
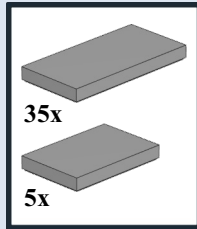

13

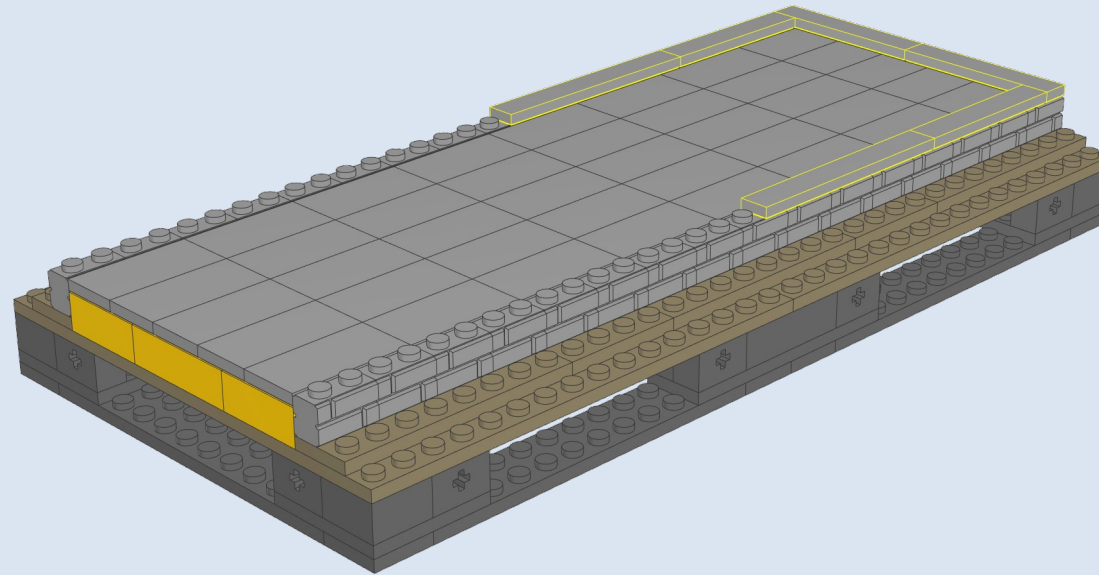
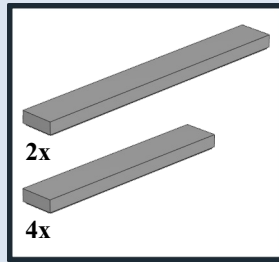

14

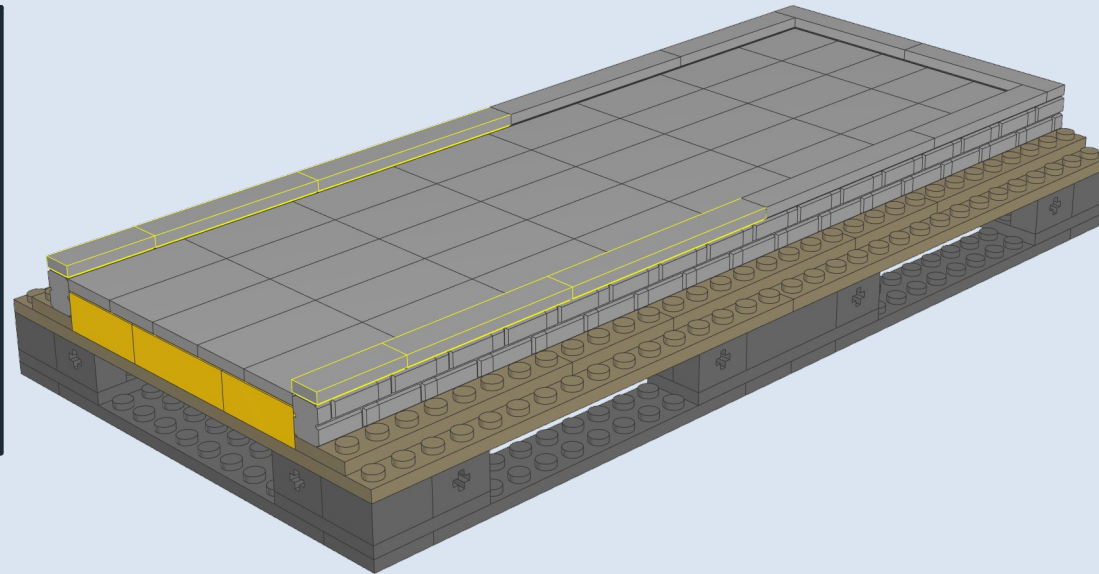
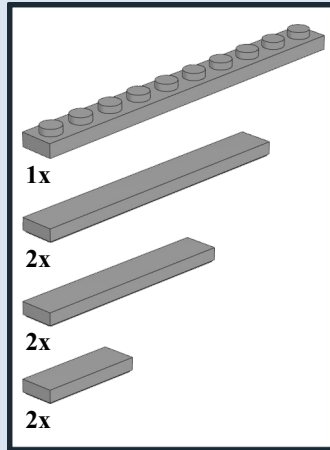

1



2x

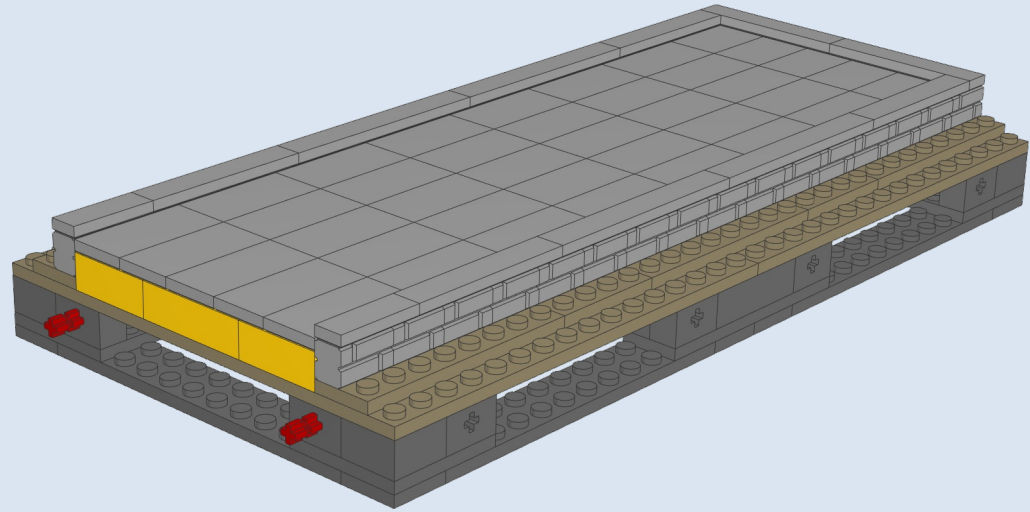

1

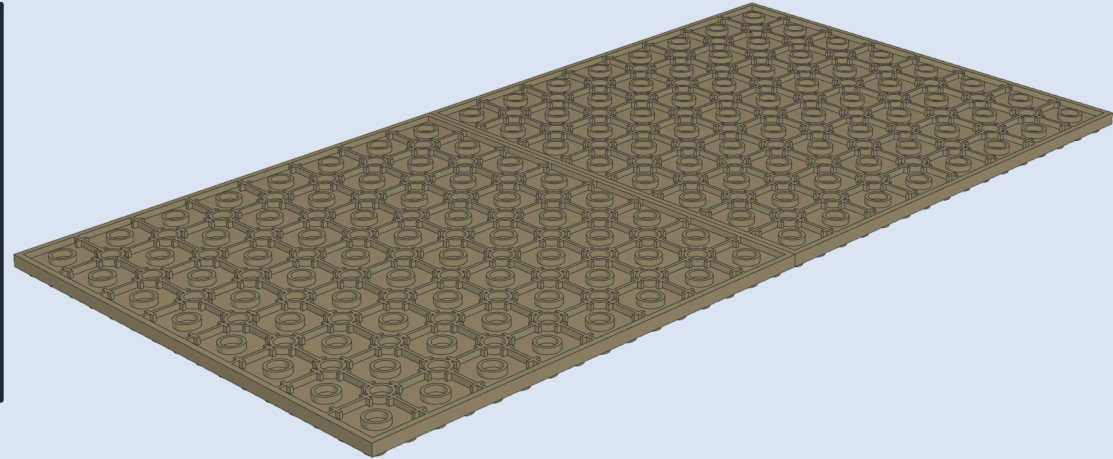
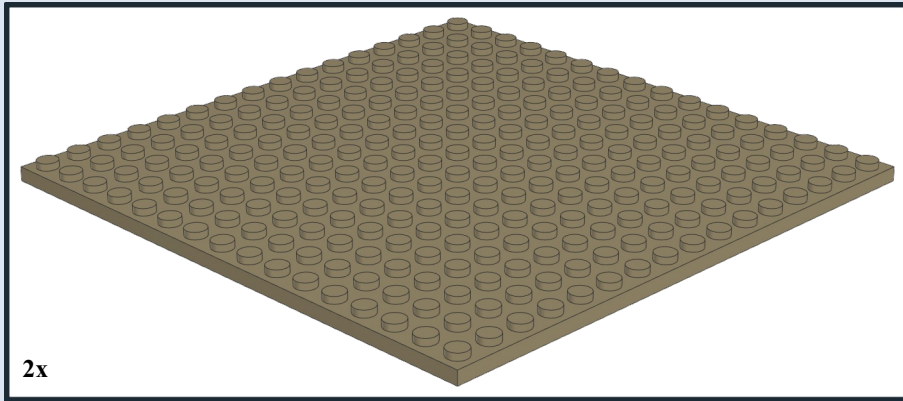

2

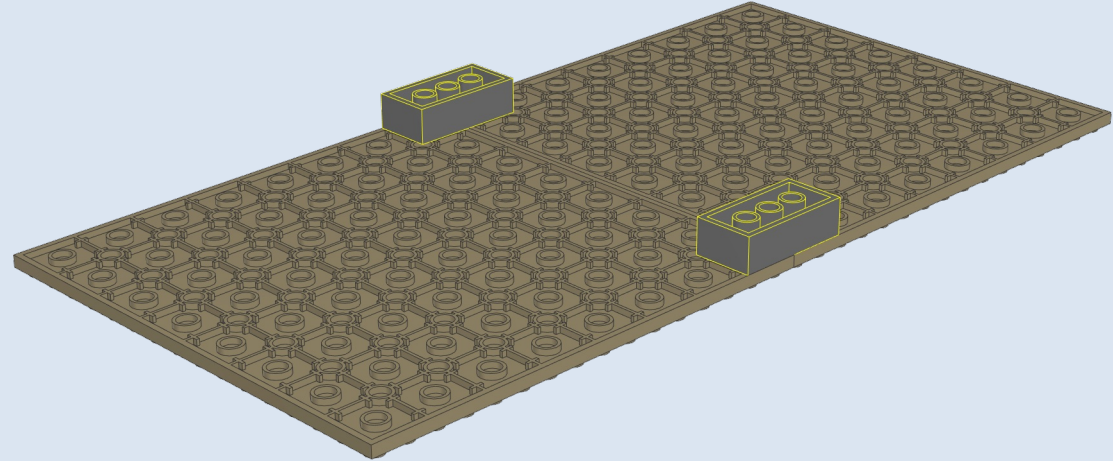
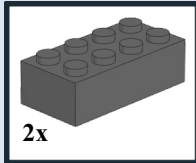

3

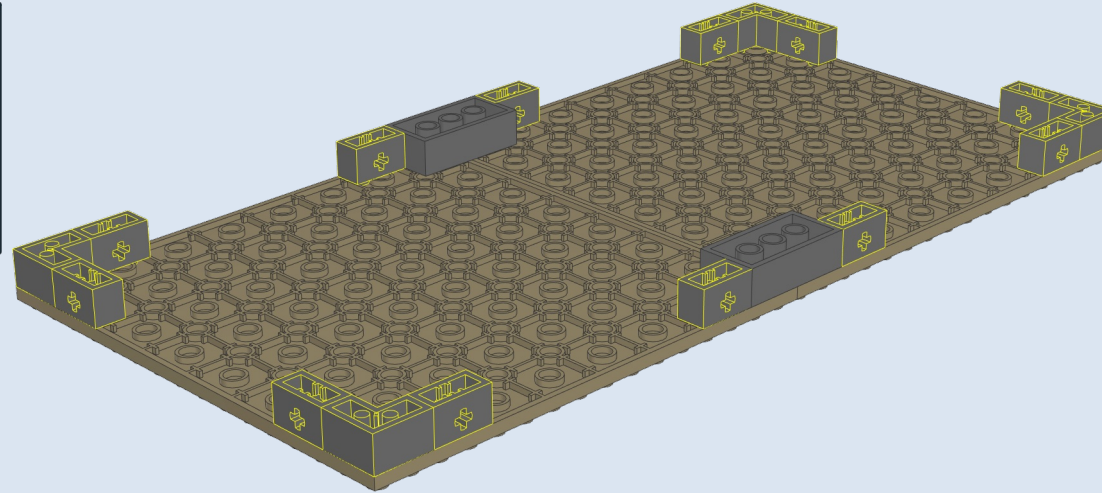
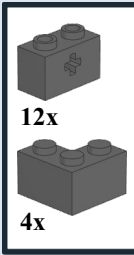

4

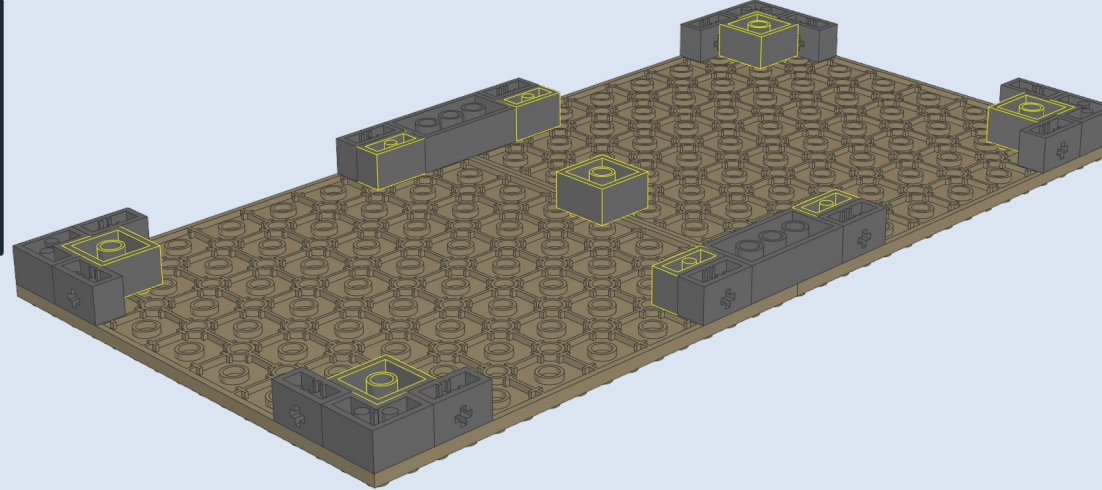
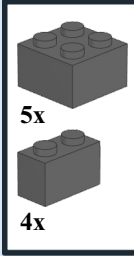

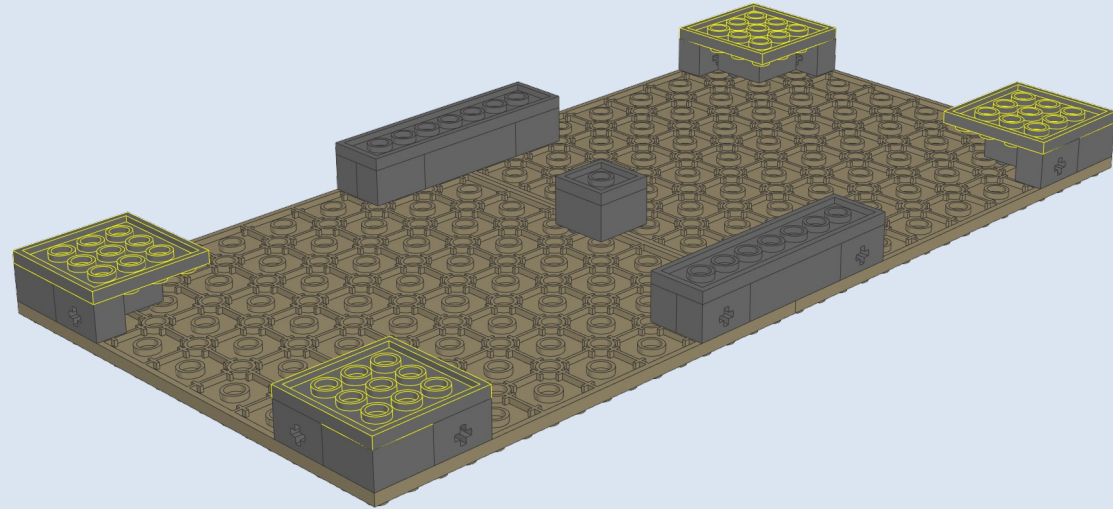
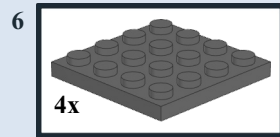
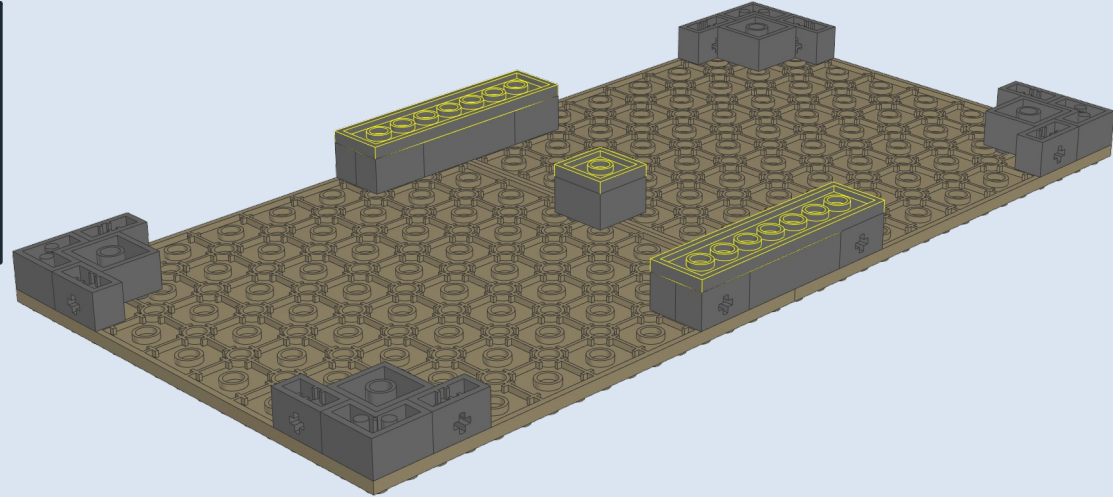
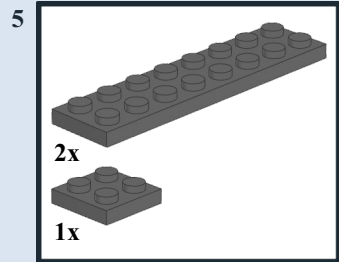

7

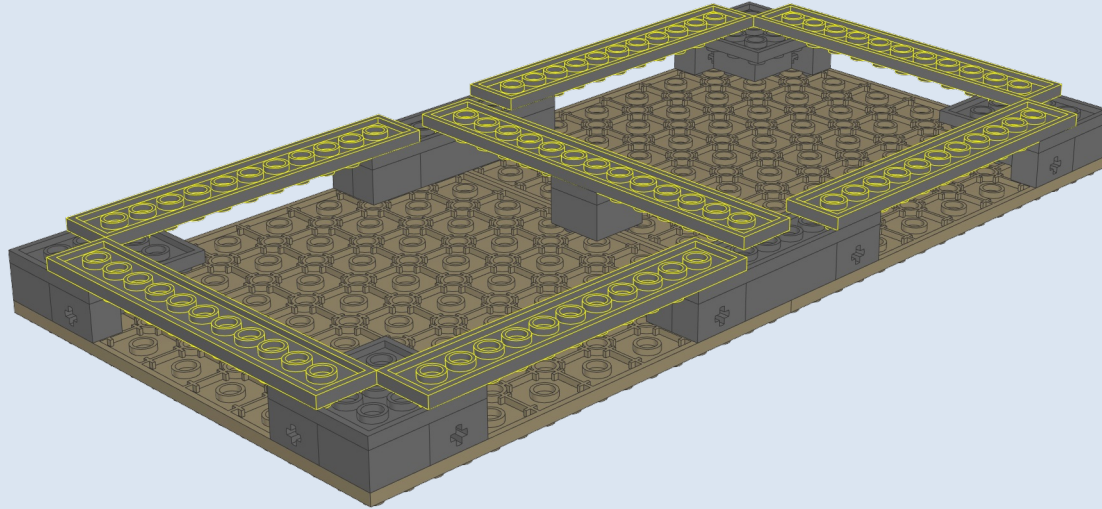
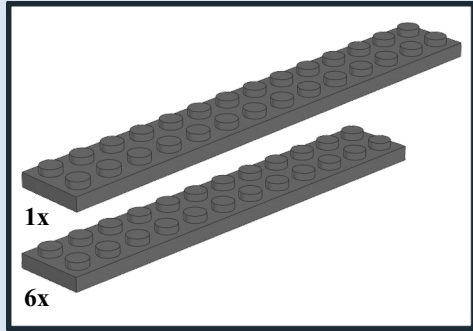

8

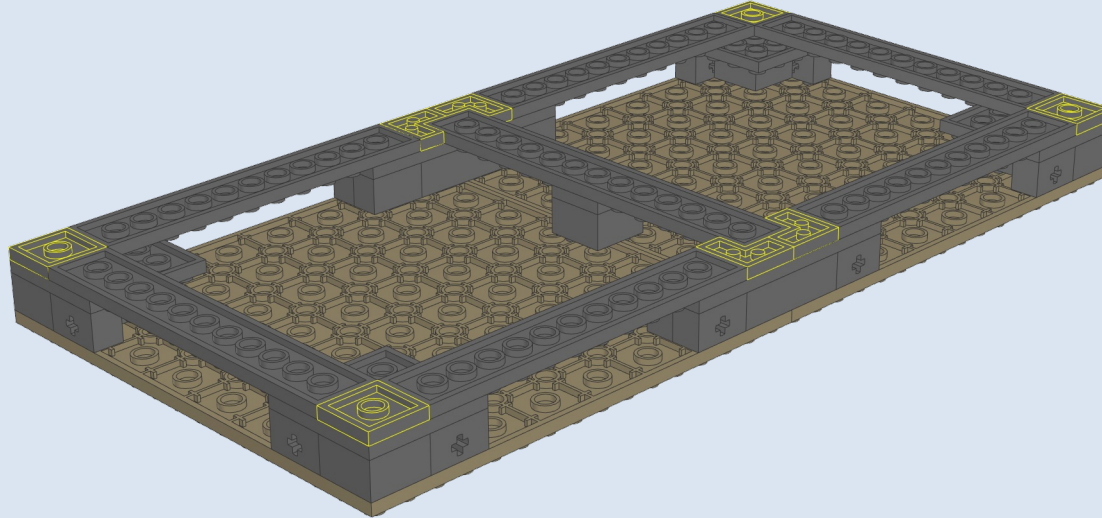
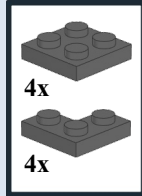

9

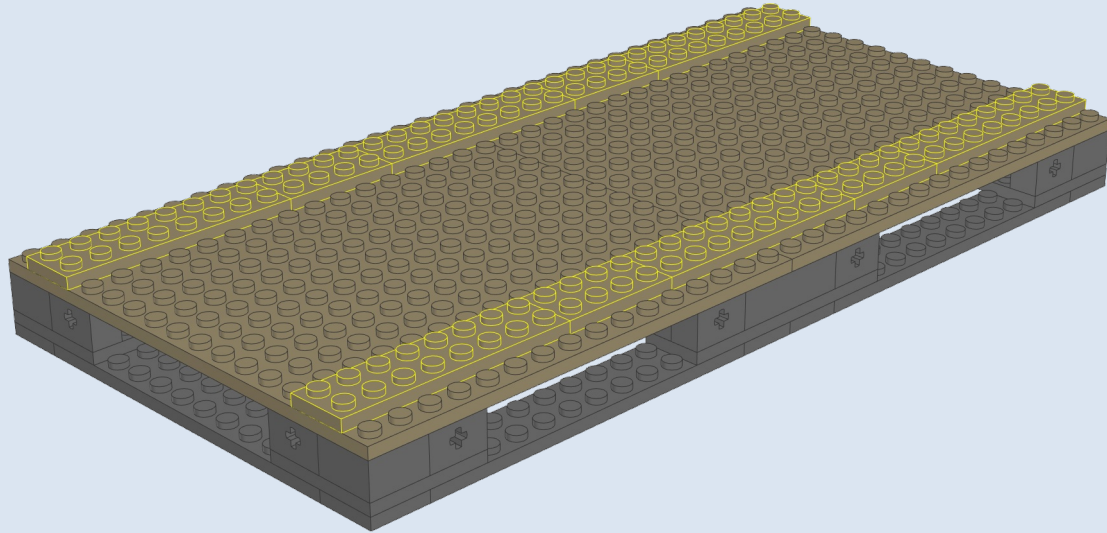
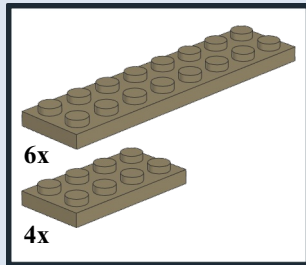

10

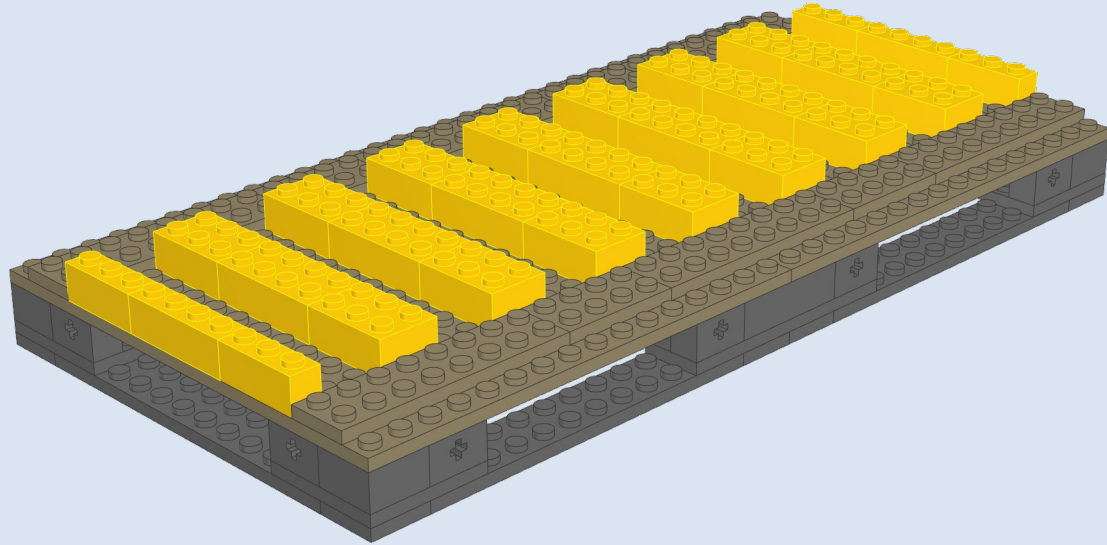
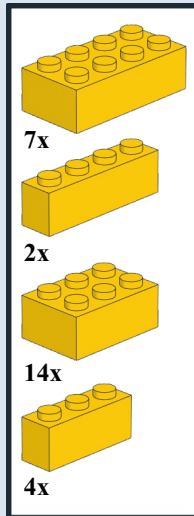

11

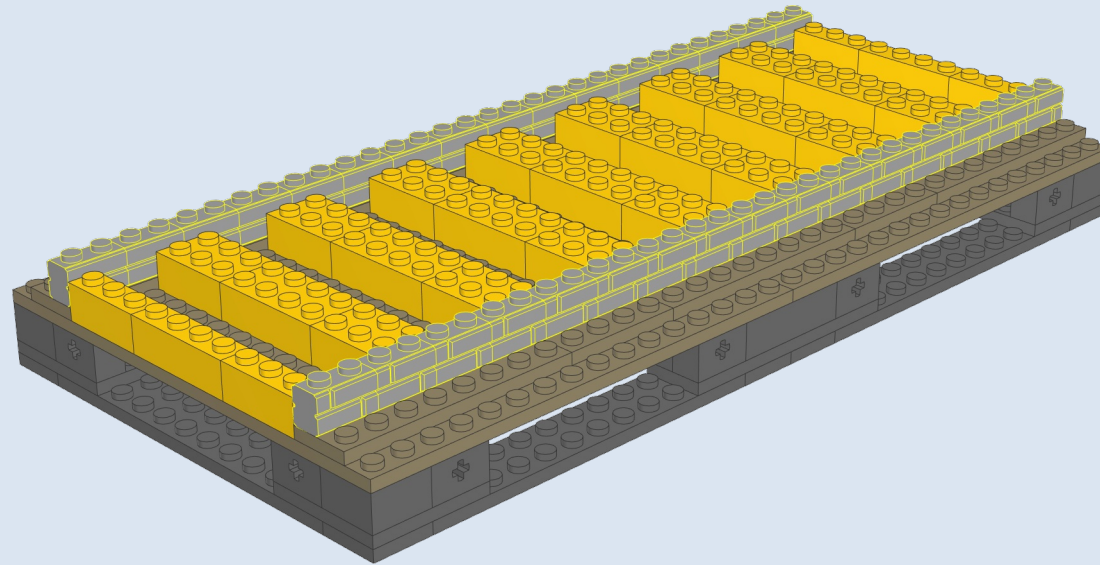
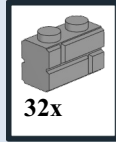

12

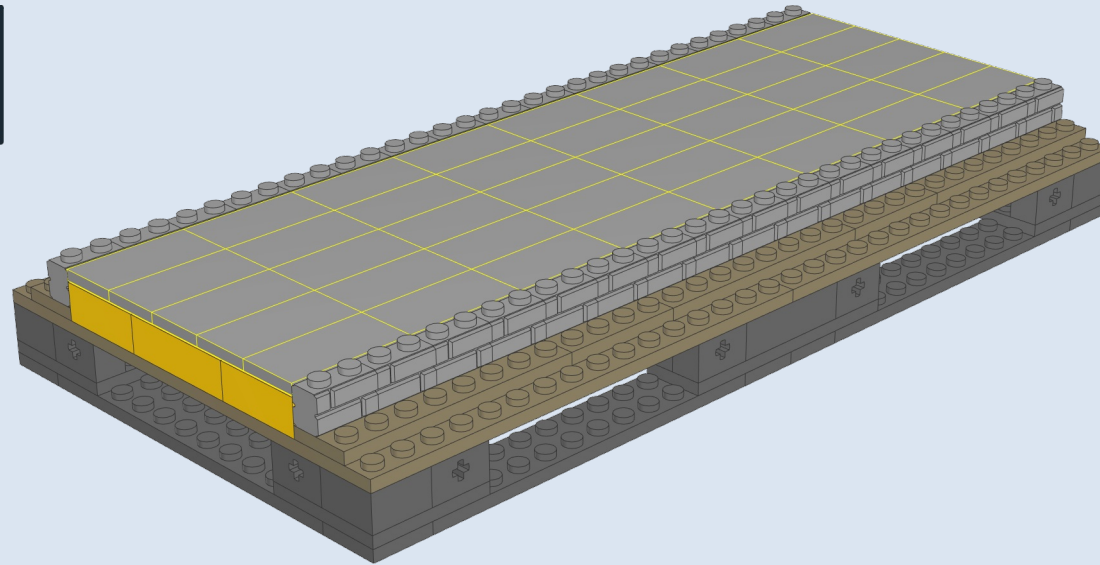
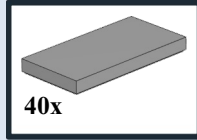

13

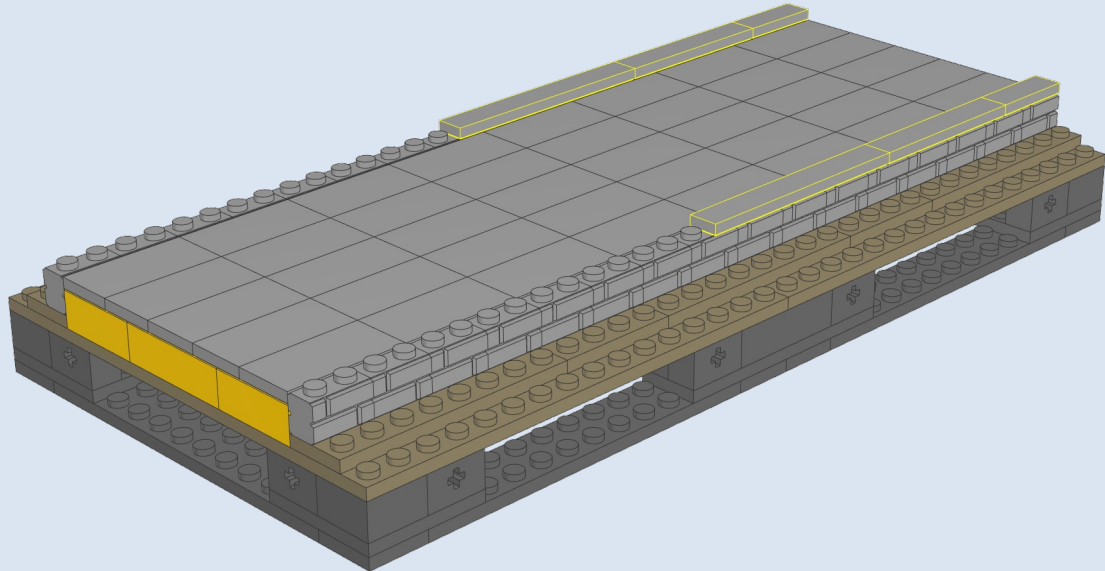
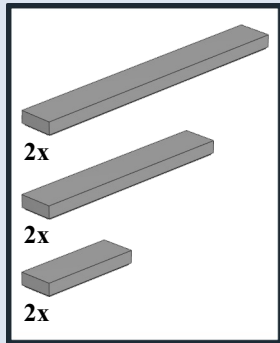

14

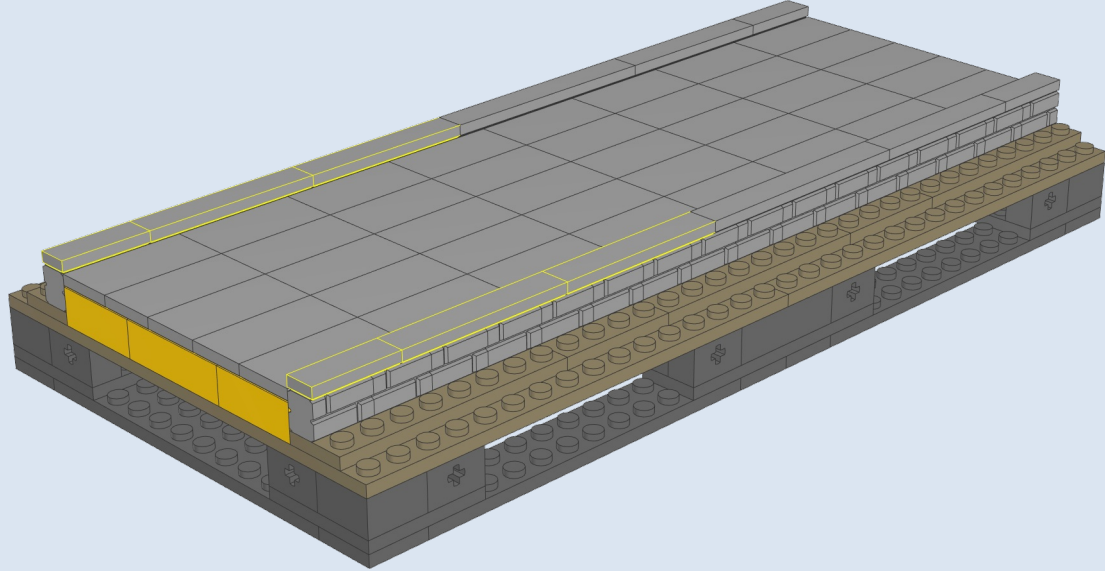
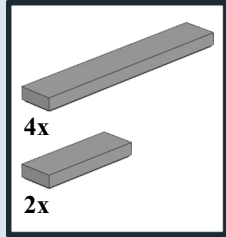

2

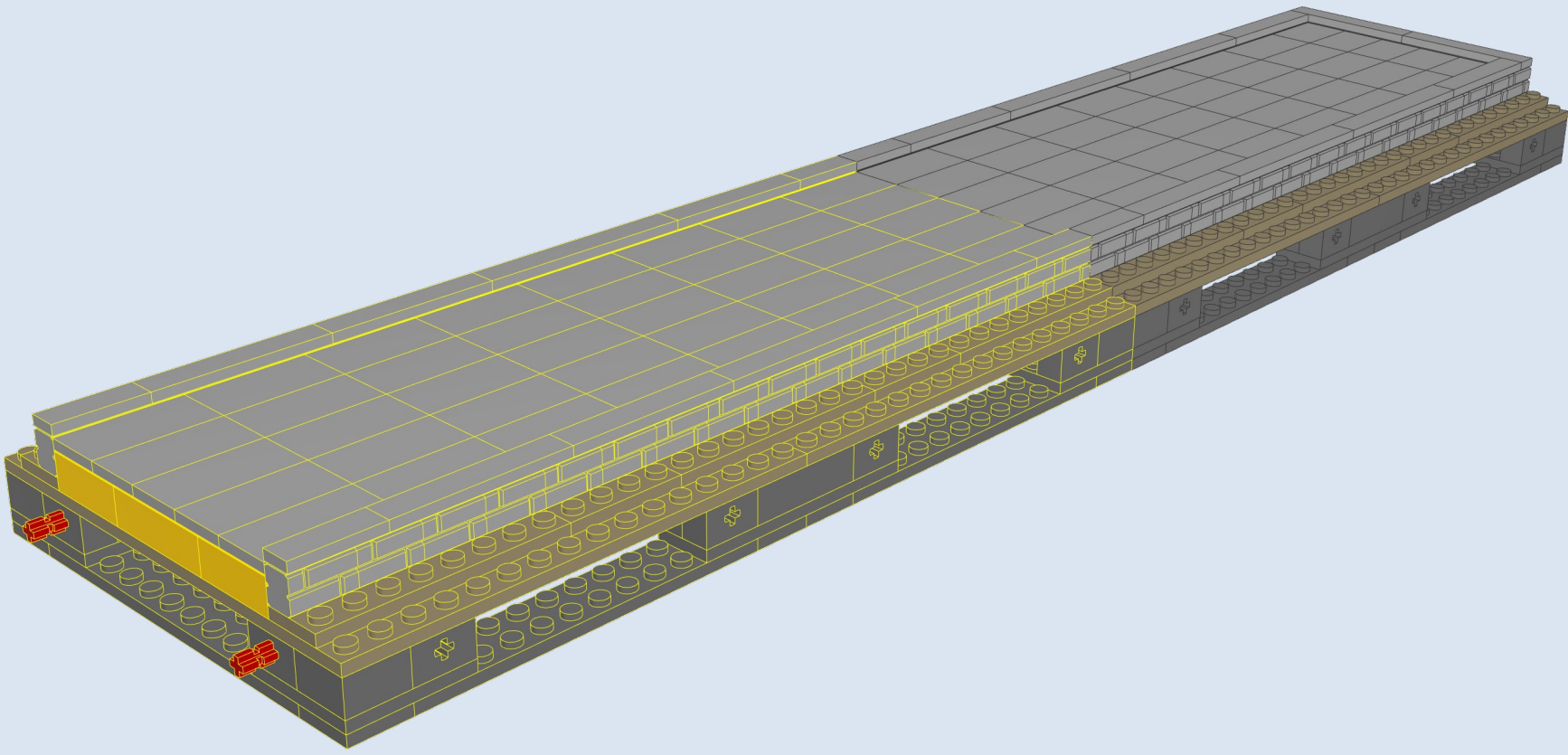

3

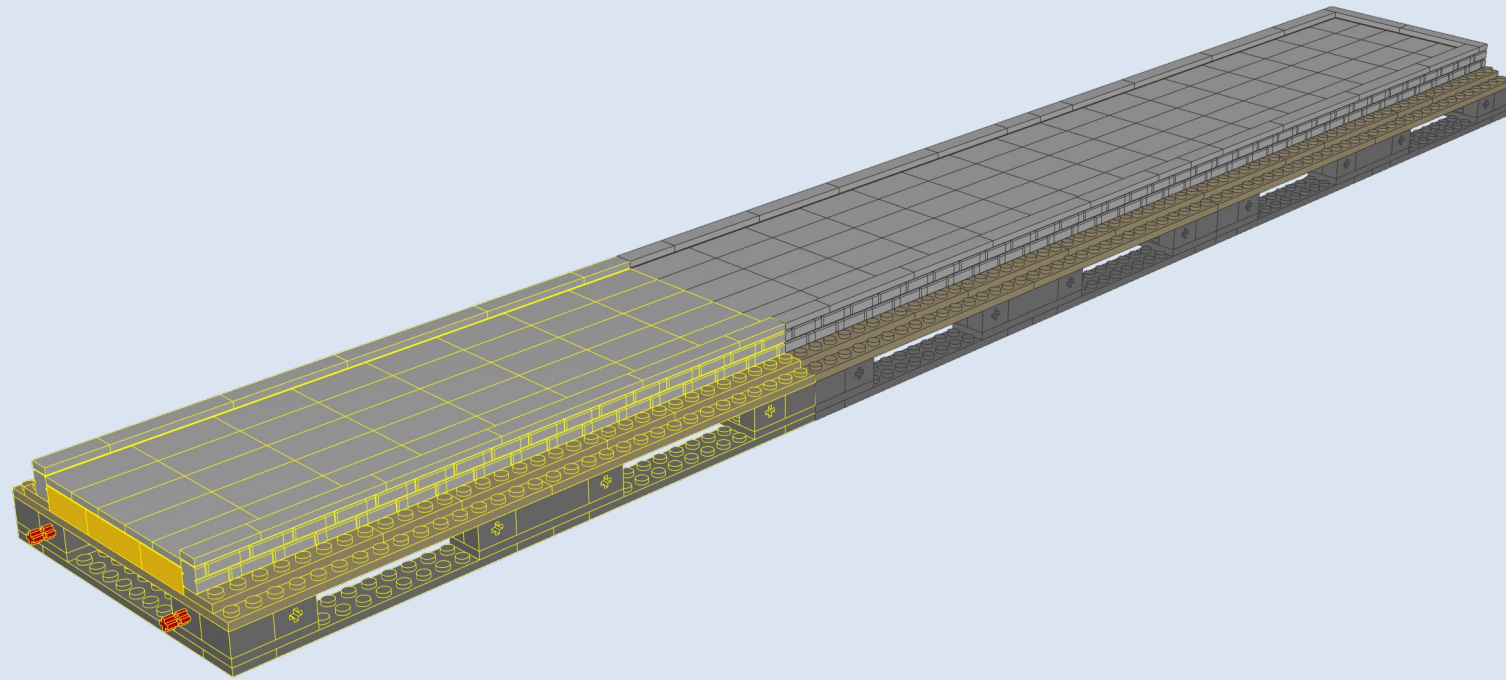

4

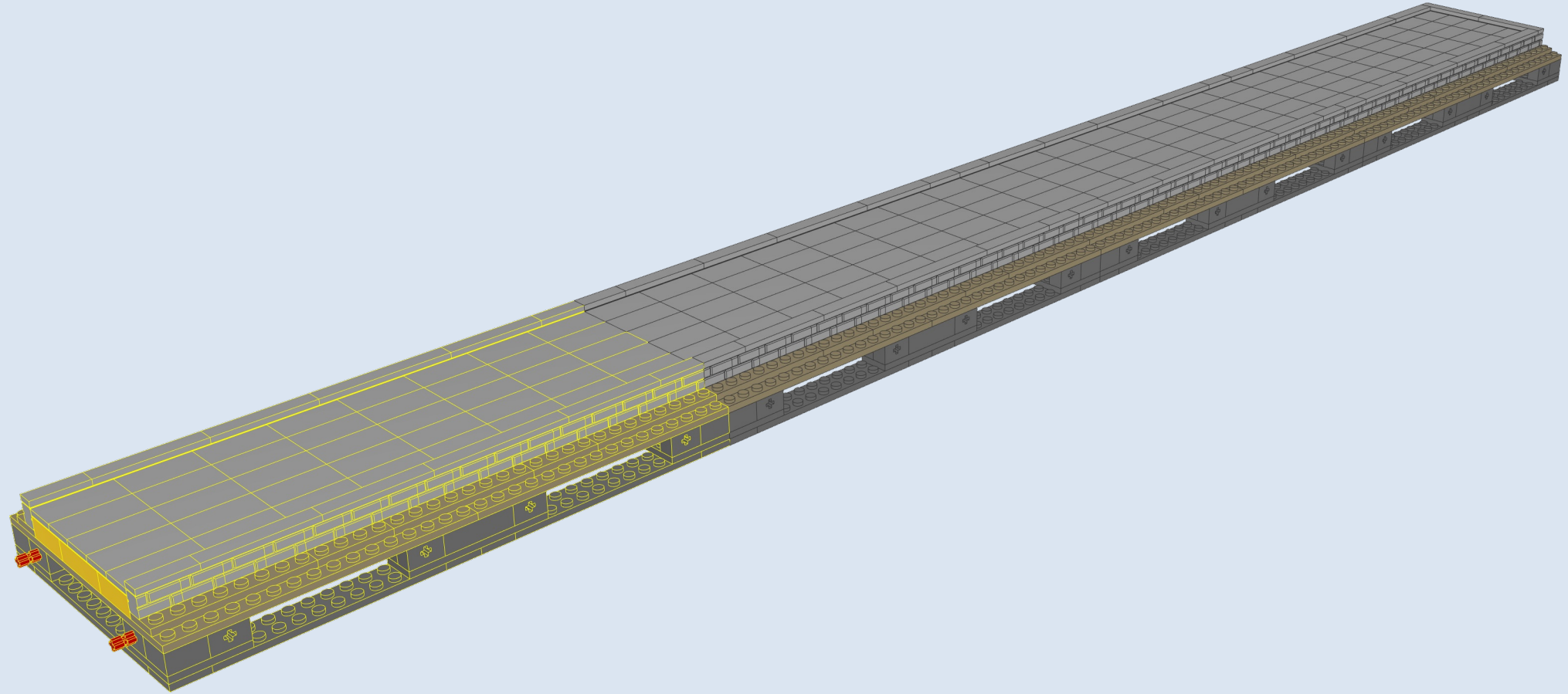

1

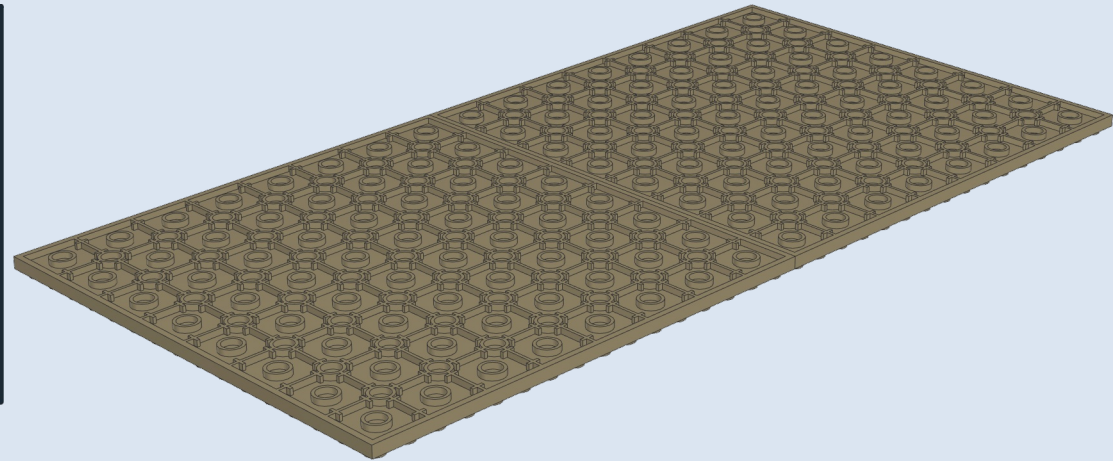
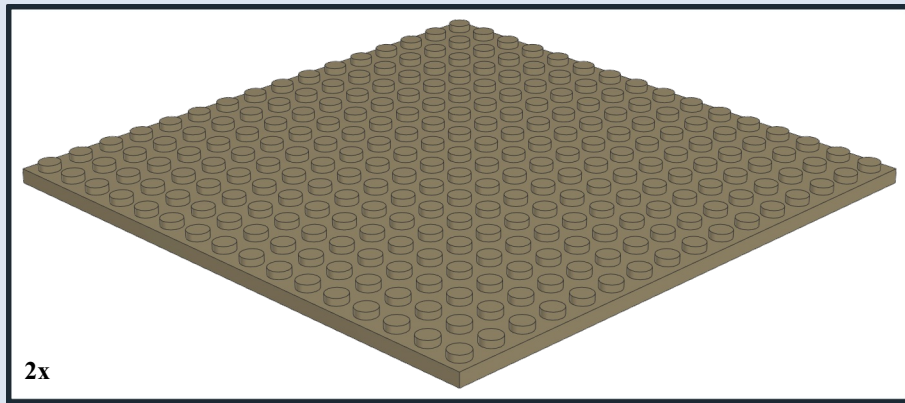

2

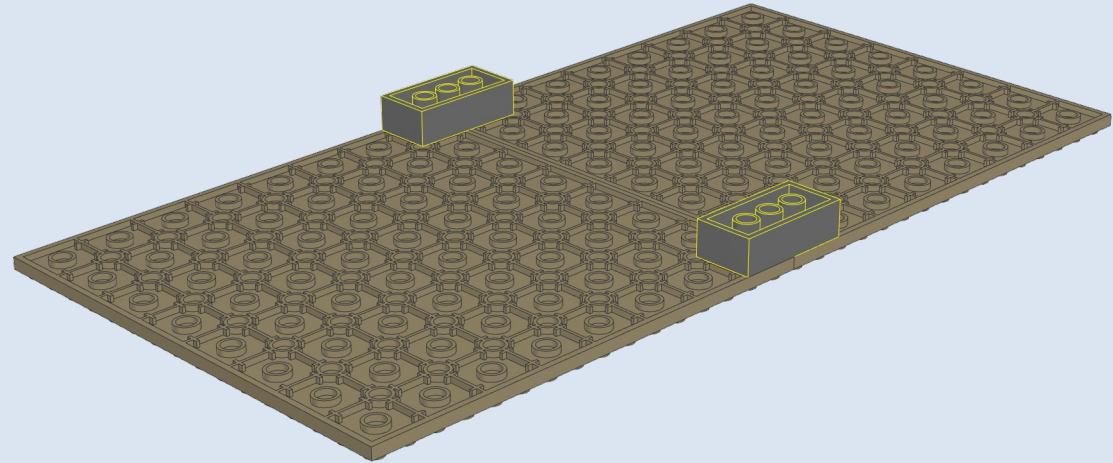
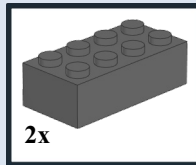

3

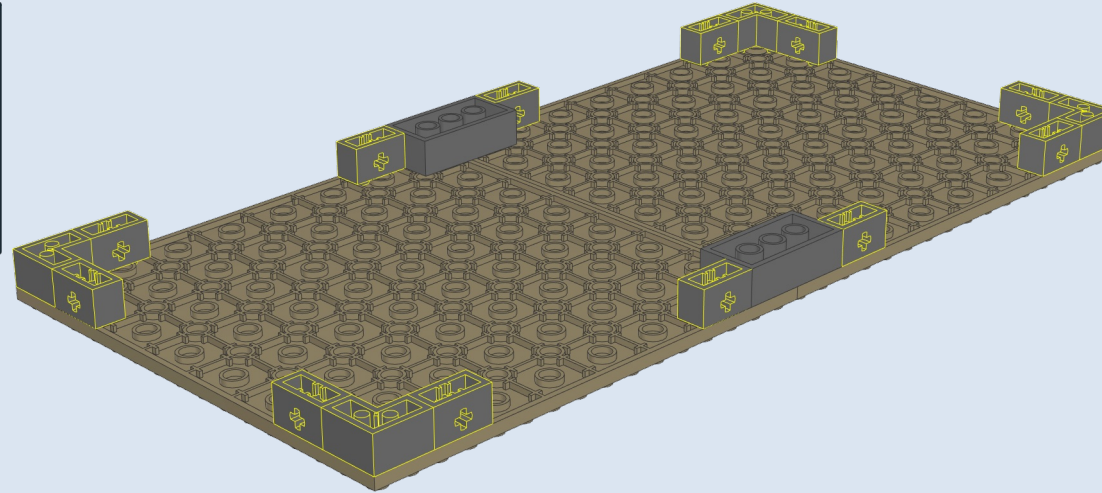
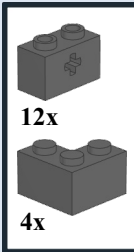

4

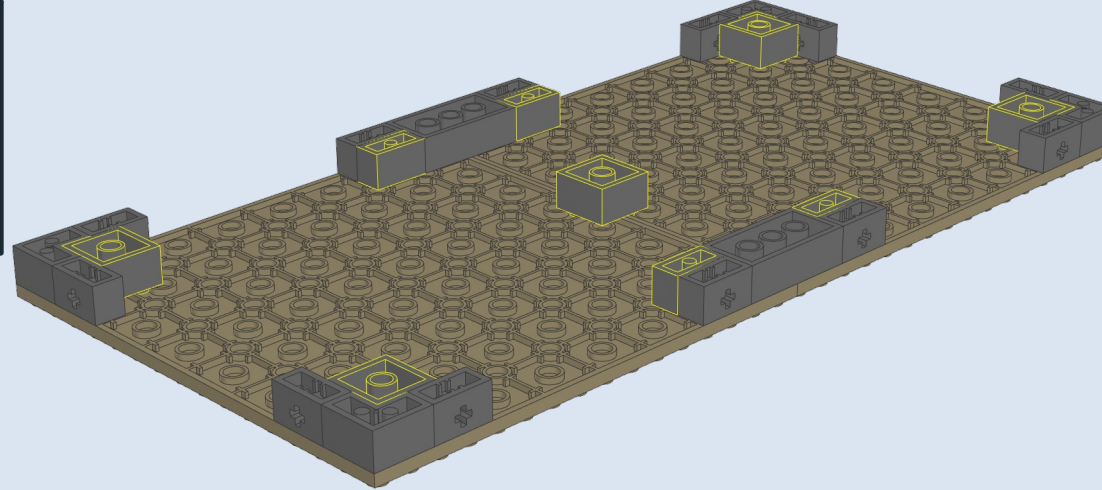
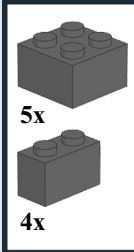

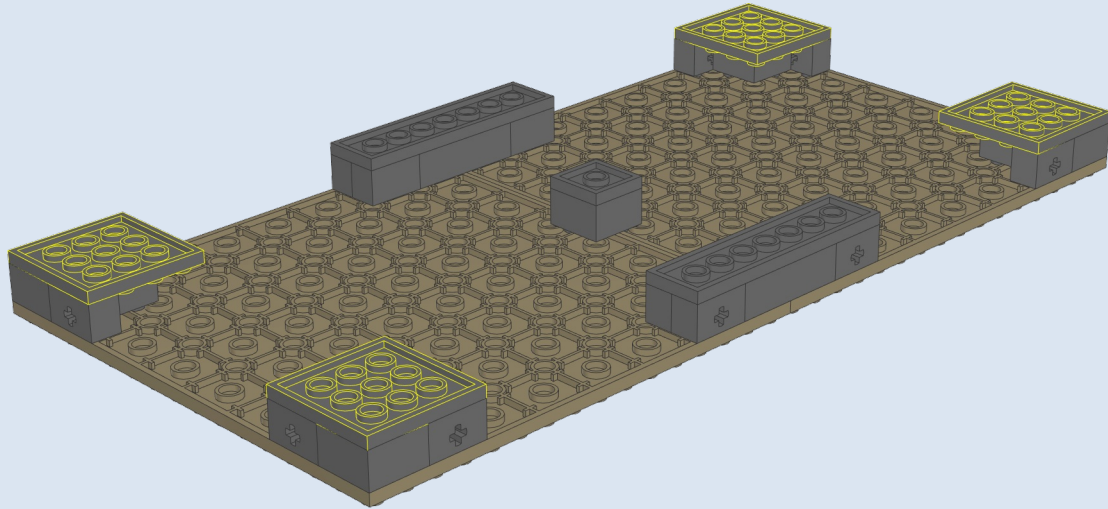
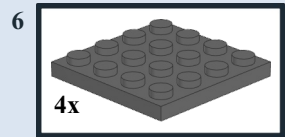
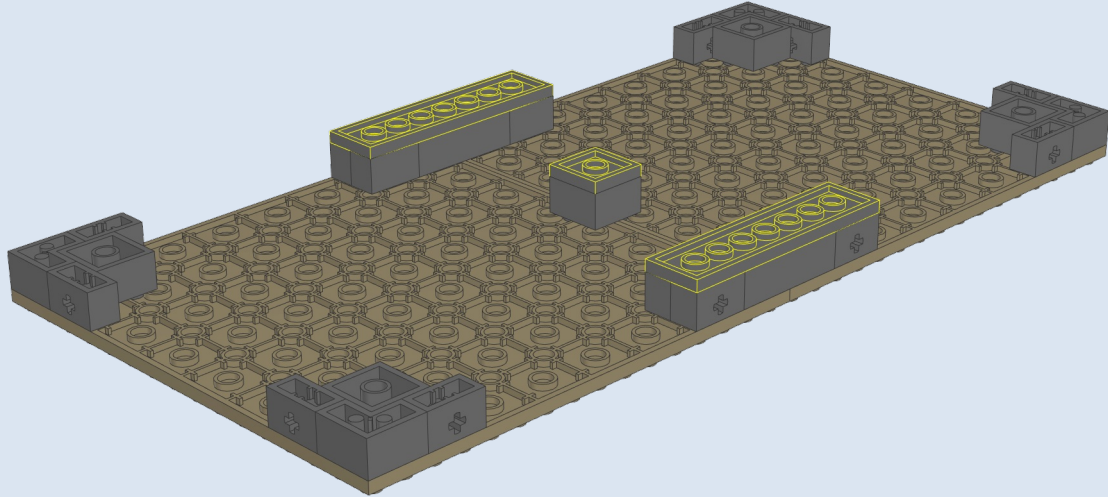
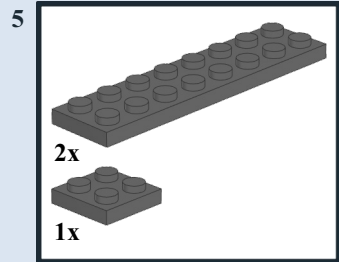

7

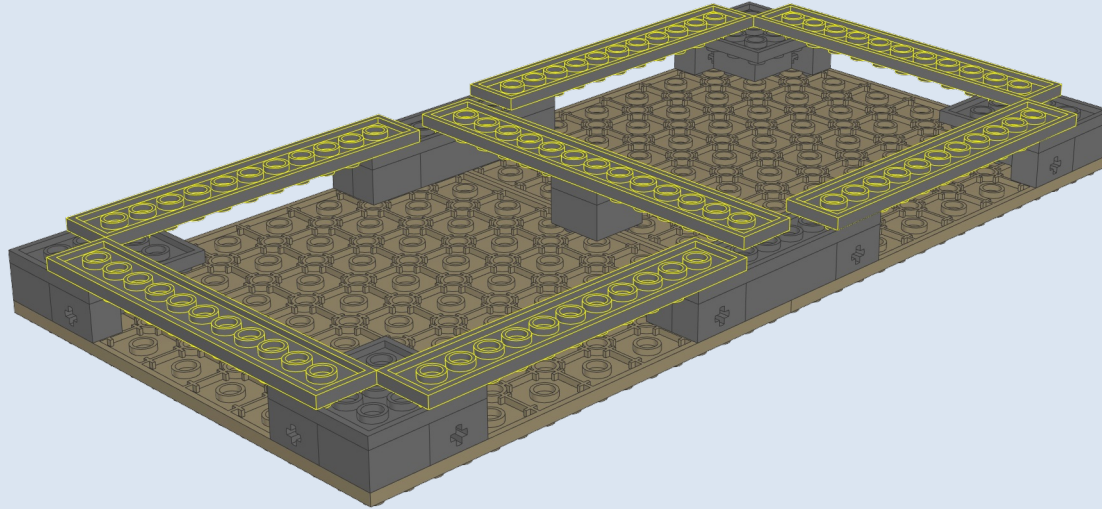
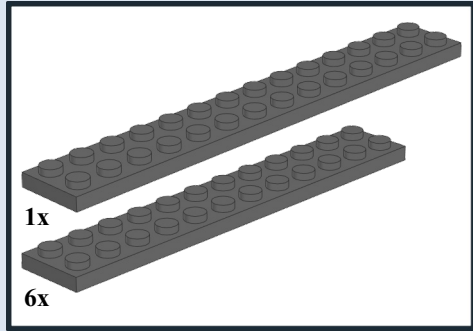

8

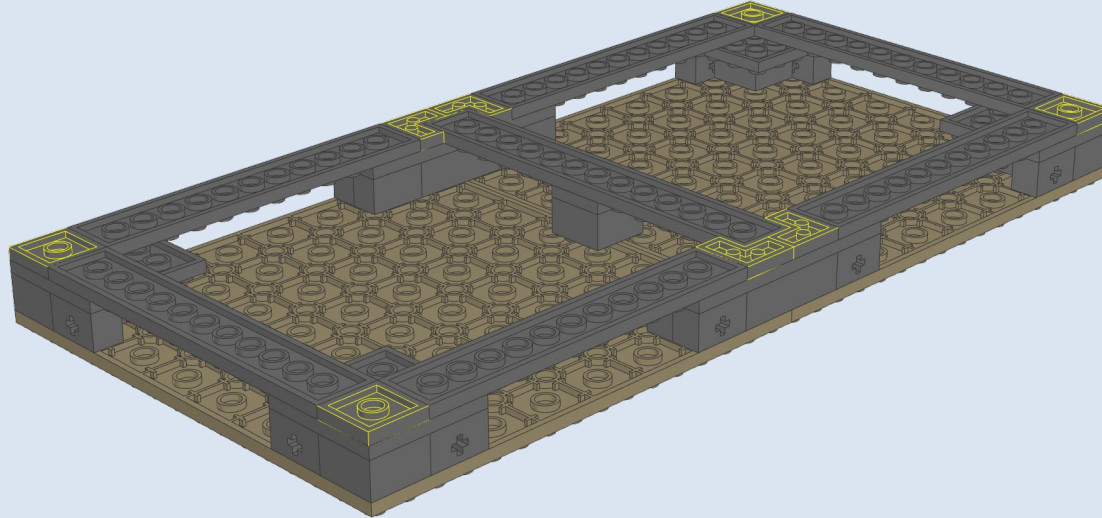
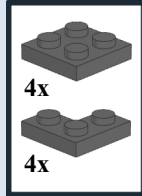

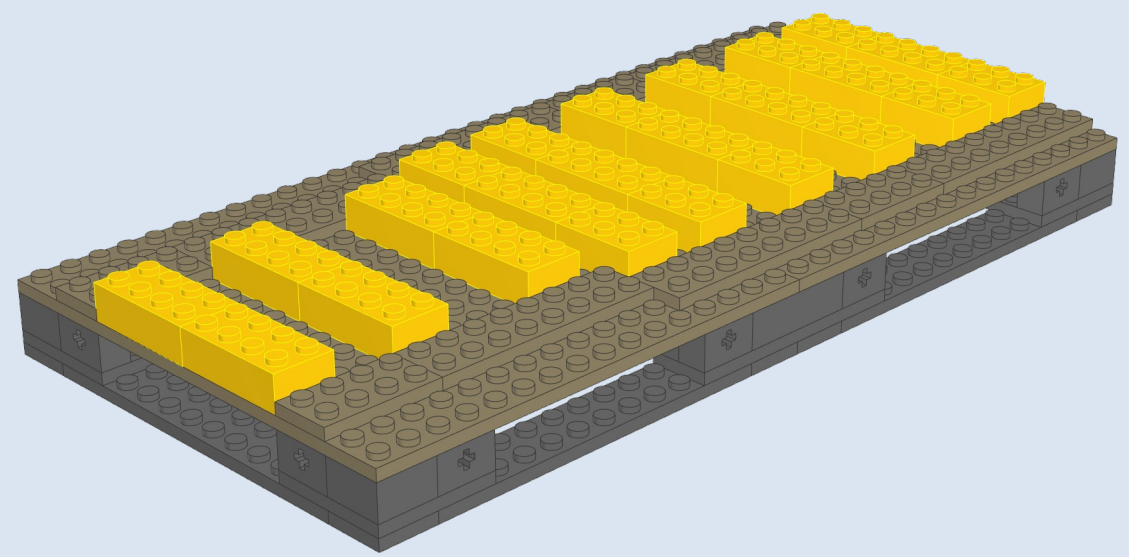
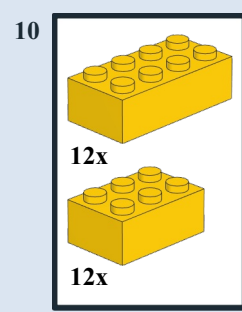
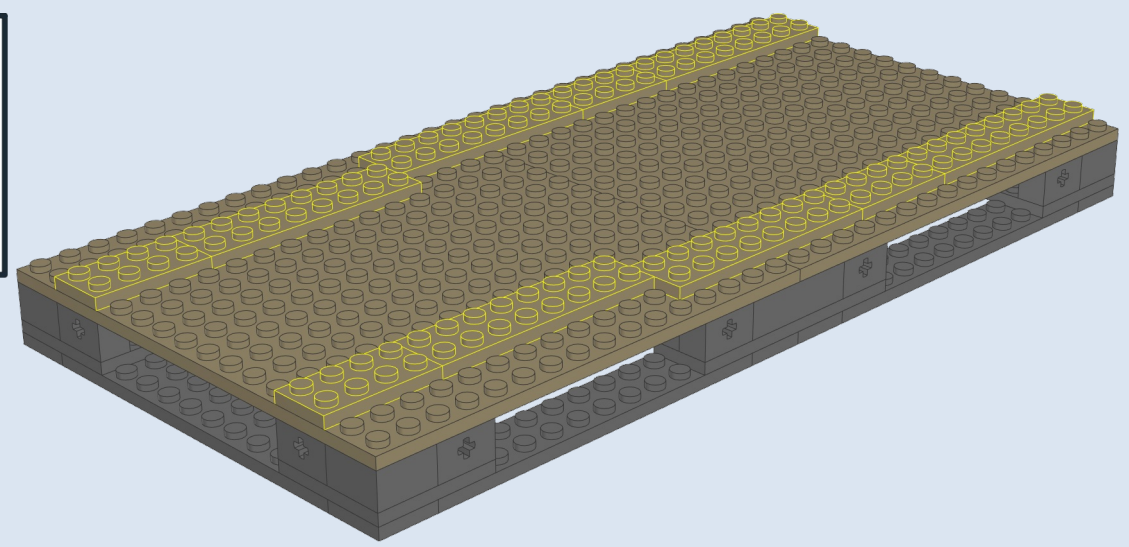
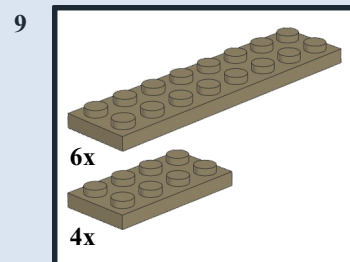

11

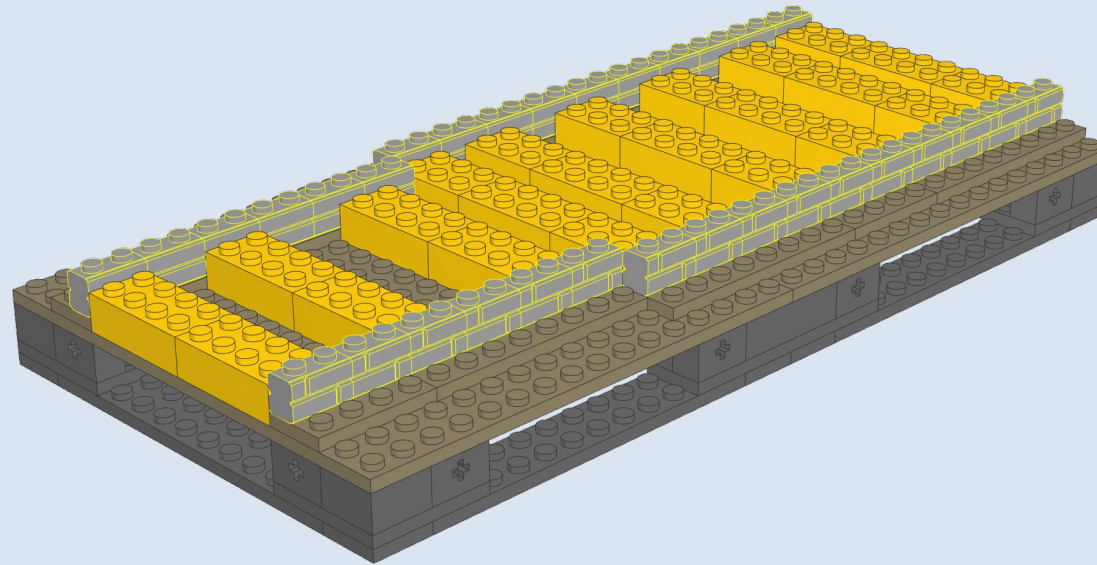
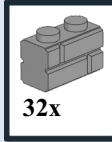

12

