

S16 Straight Ballasted Buffer Stop

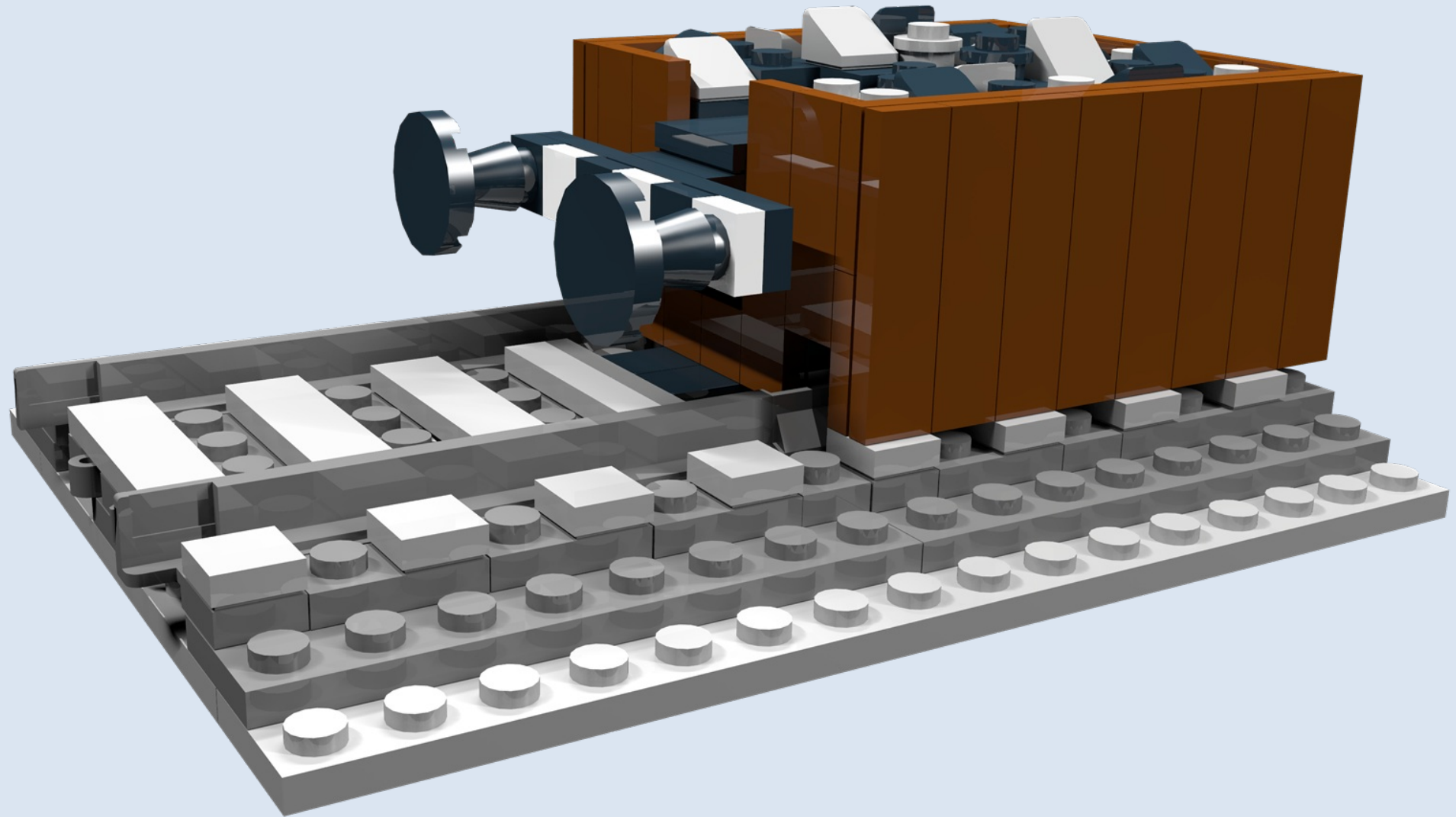

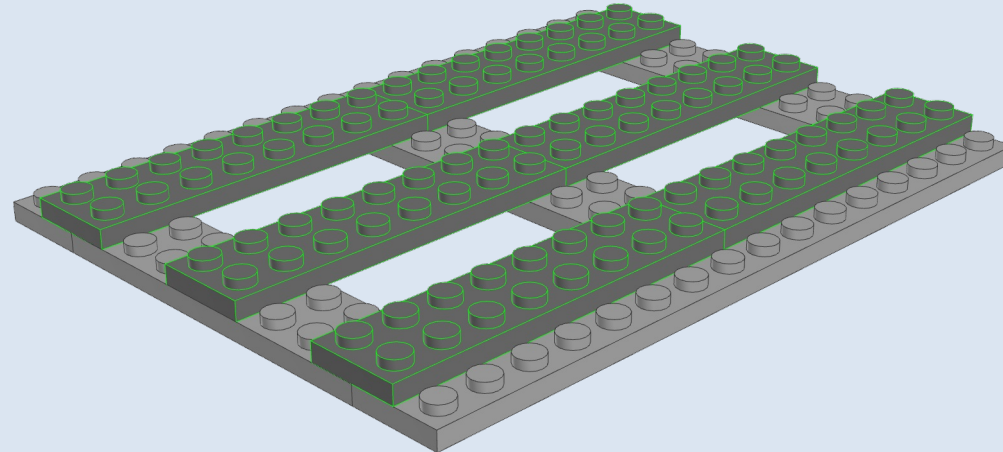

3

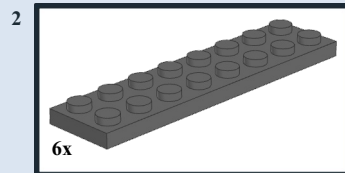
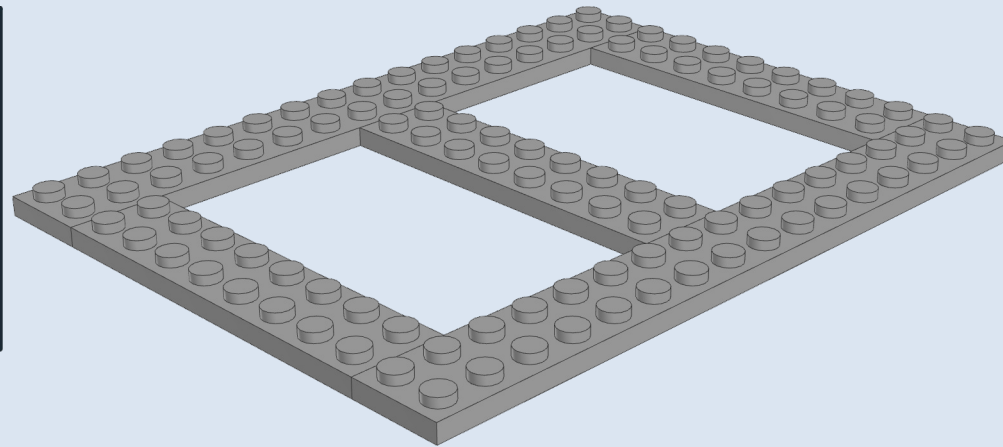
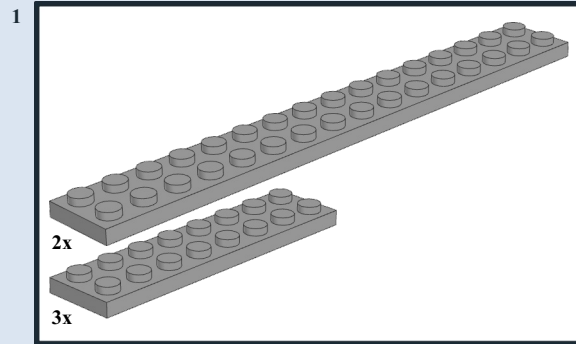
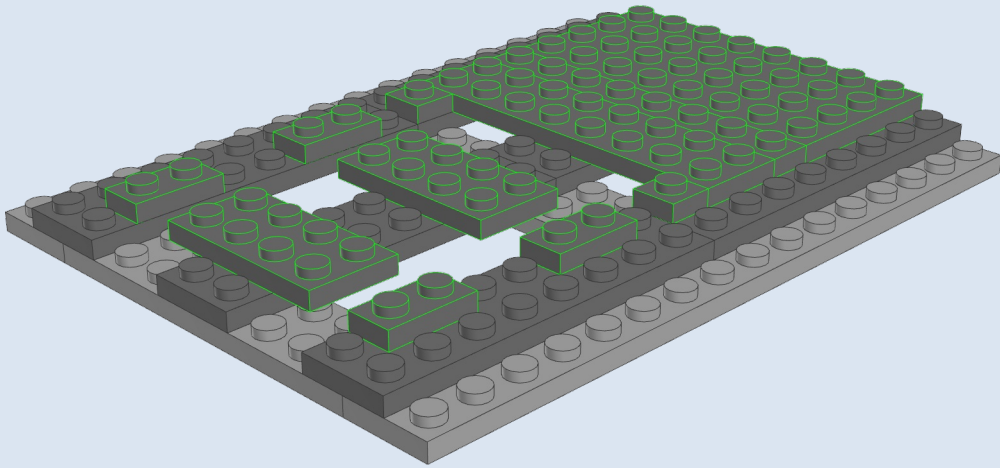
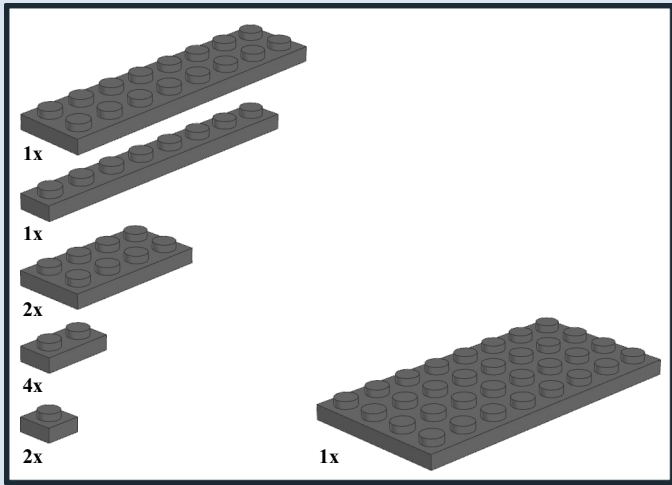



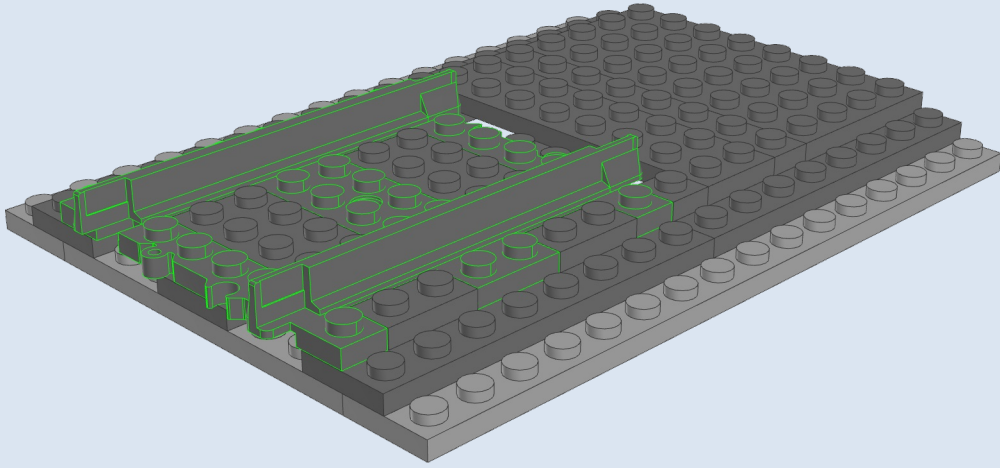
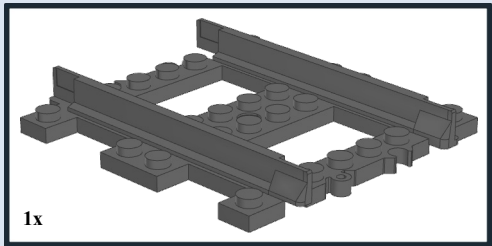

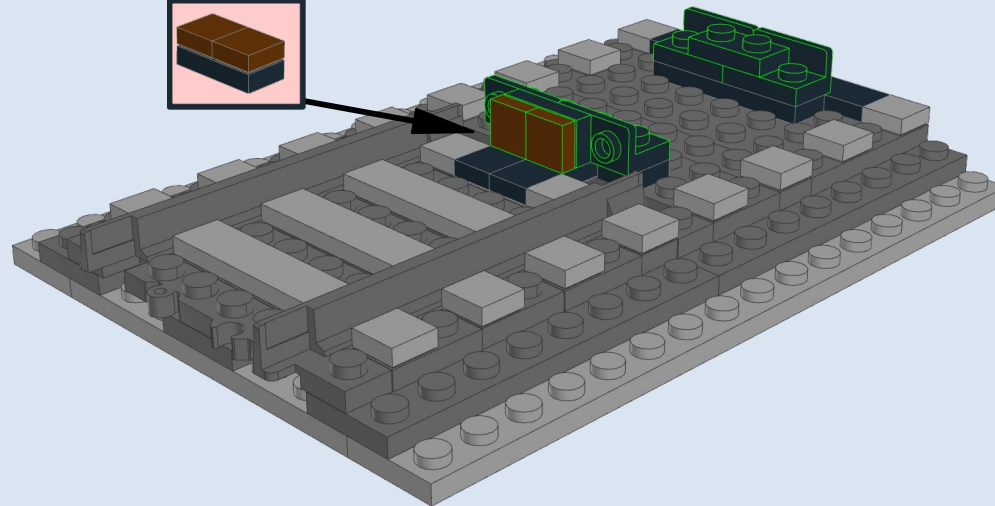
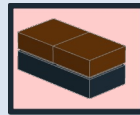
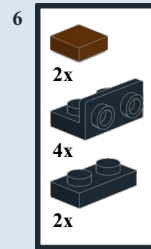
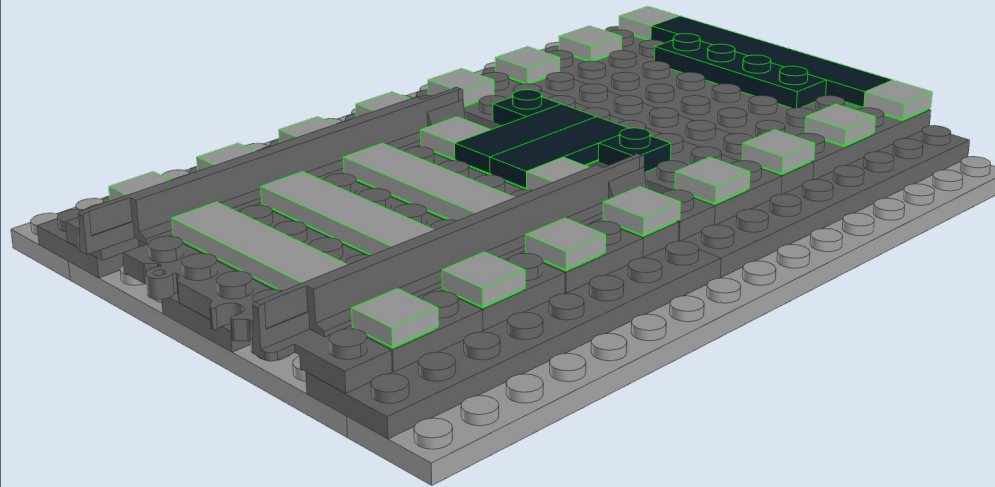
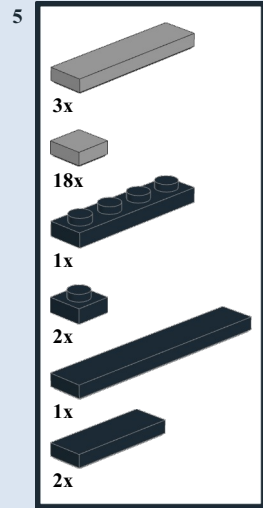
4

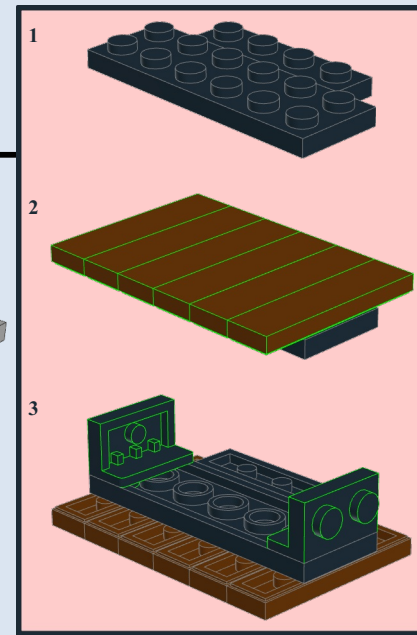
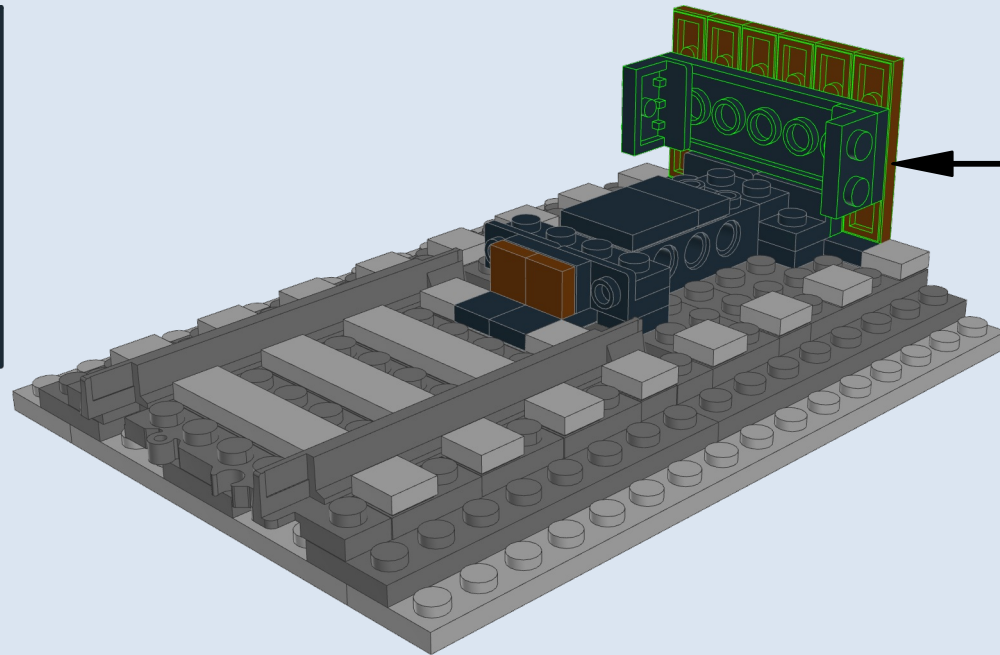
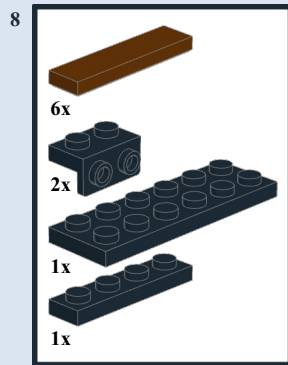
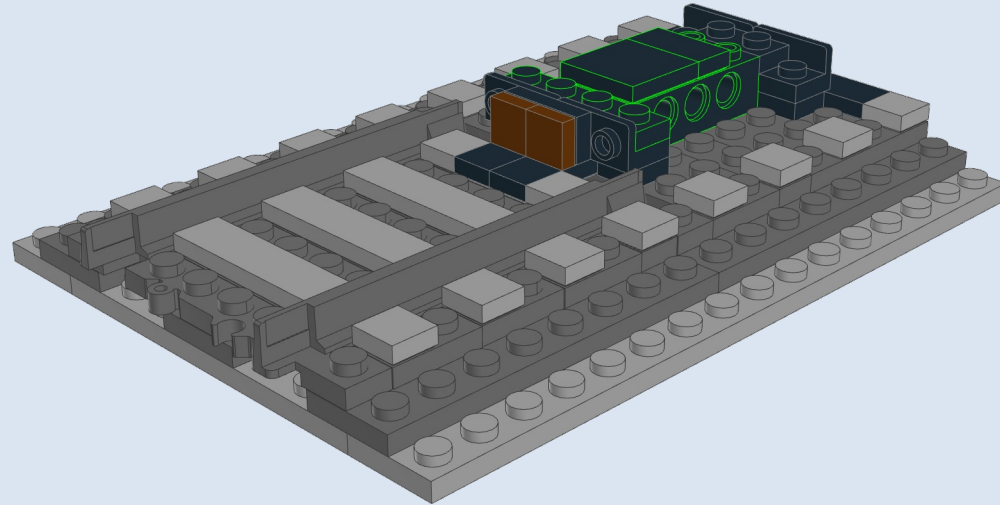
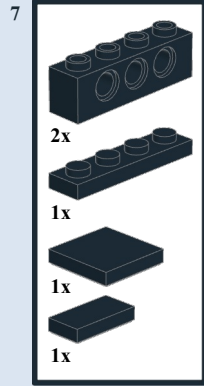







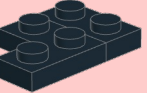
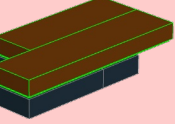
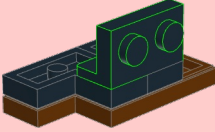

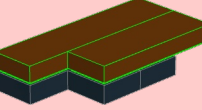
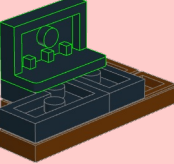
- 9
- 2x 
 - 2x 
 - 2x 
 - 2x 
 - 2x 

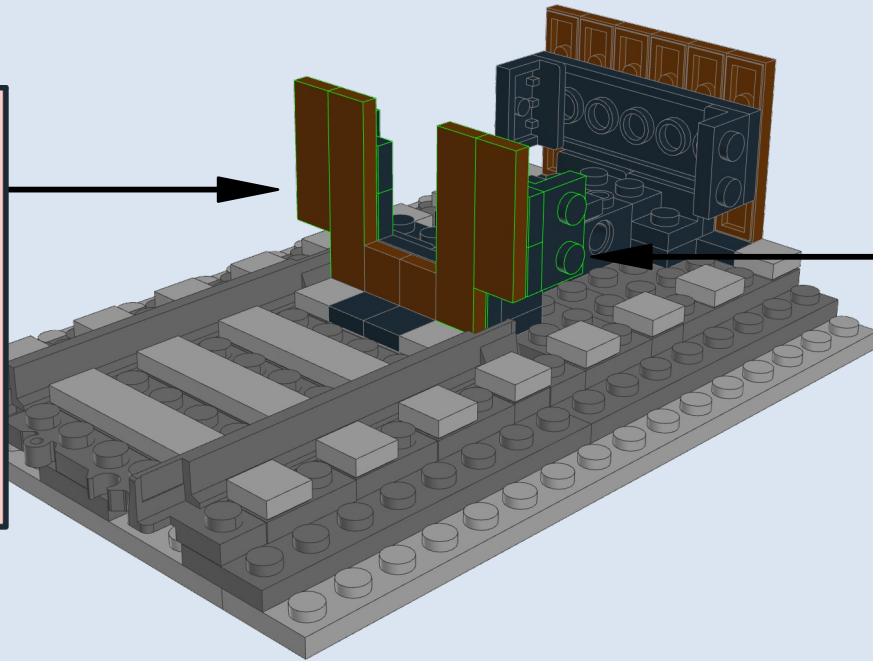
- 1 
- 2 
- 3 

- 1 
- 2 
- 3 

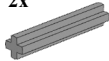

- 10
- 2x 
 - 2x 
 - 2x 
 - 2x 

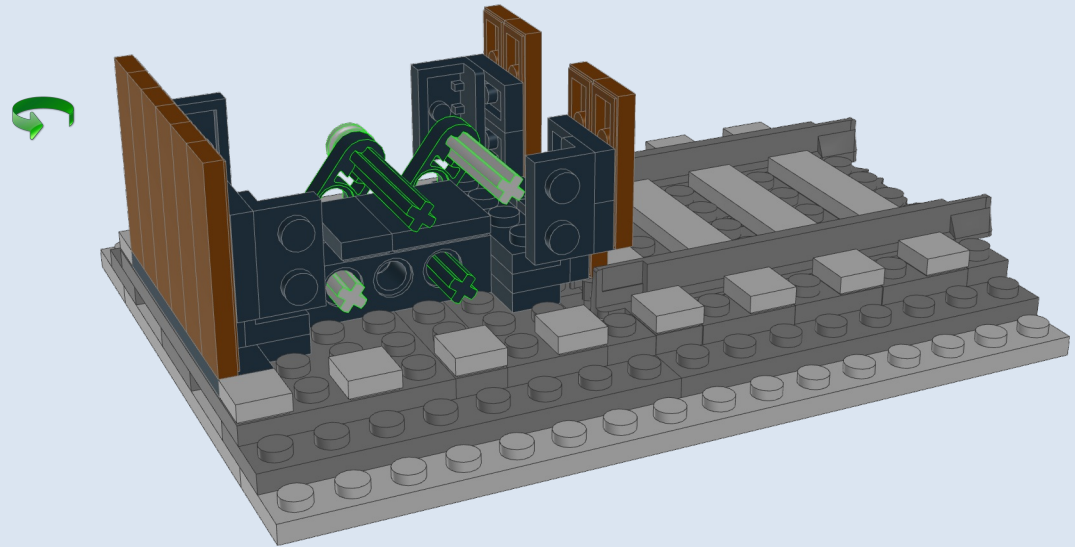

11

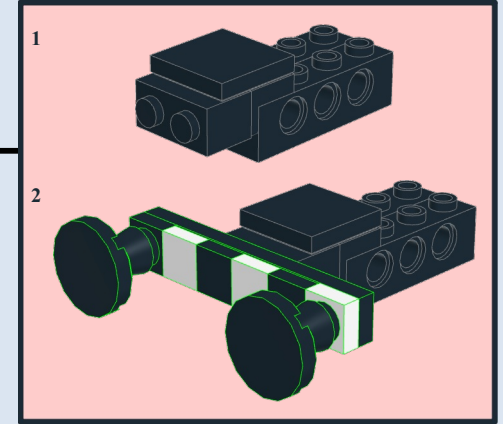
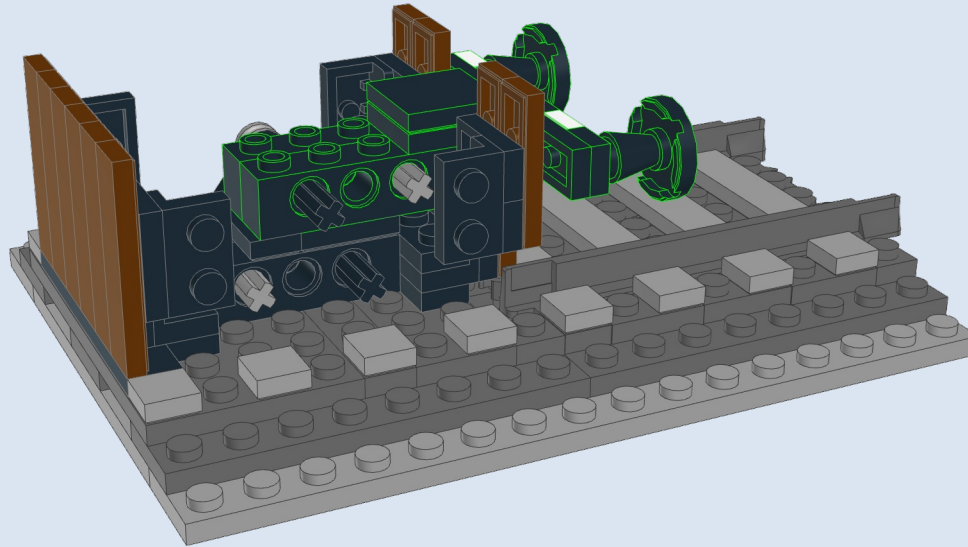
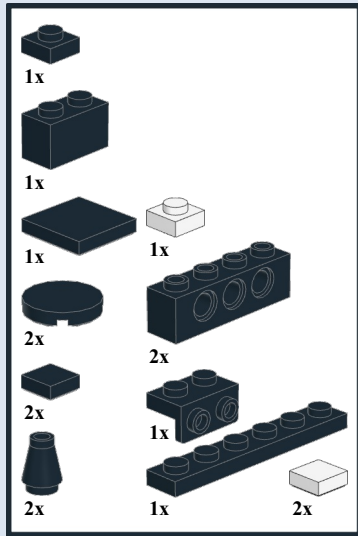

12

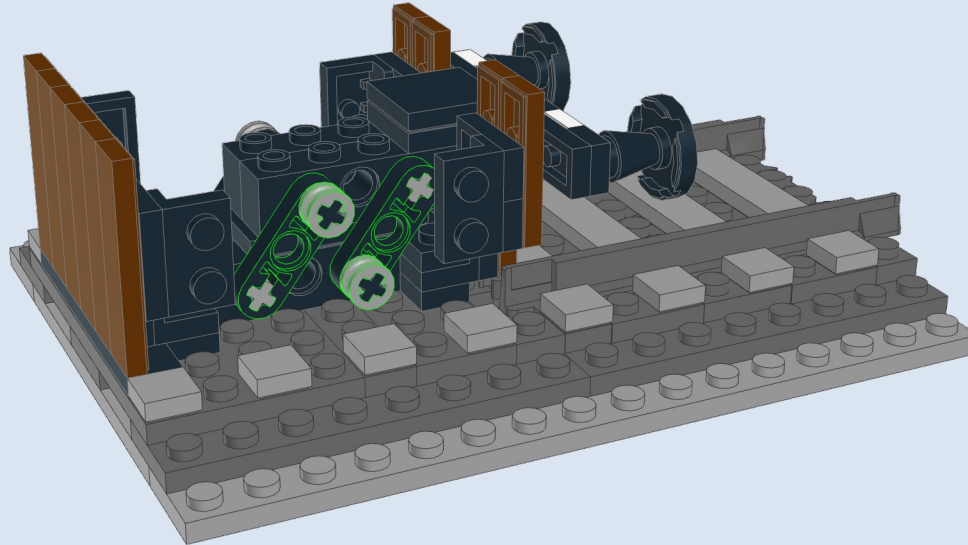
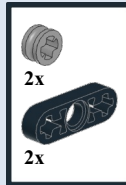

13

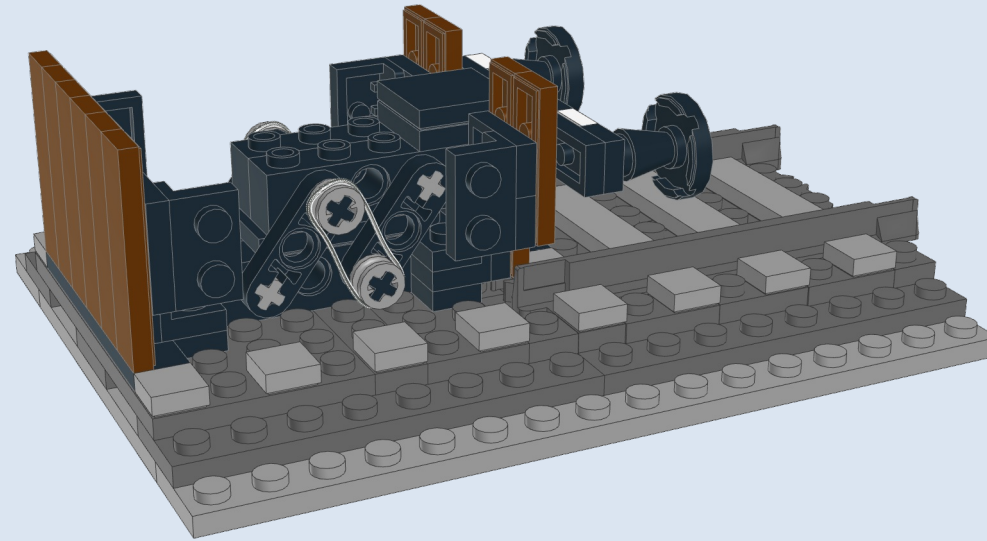

14

