

# Crossing Ballasted

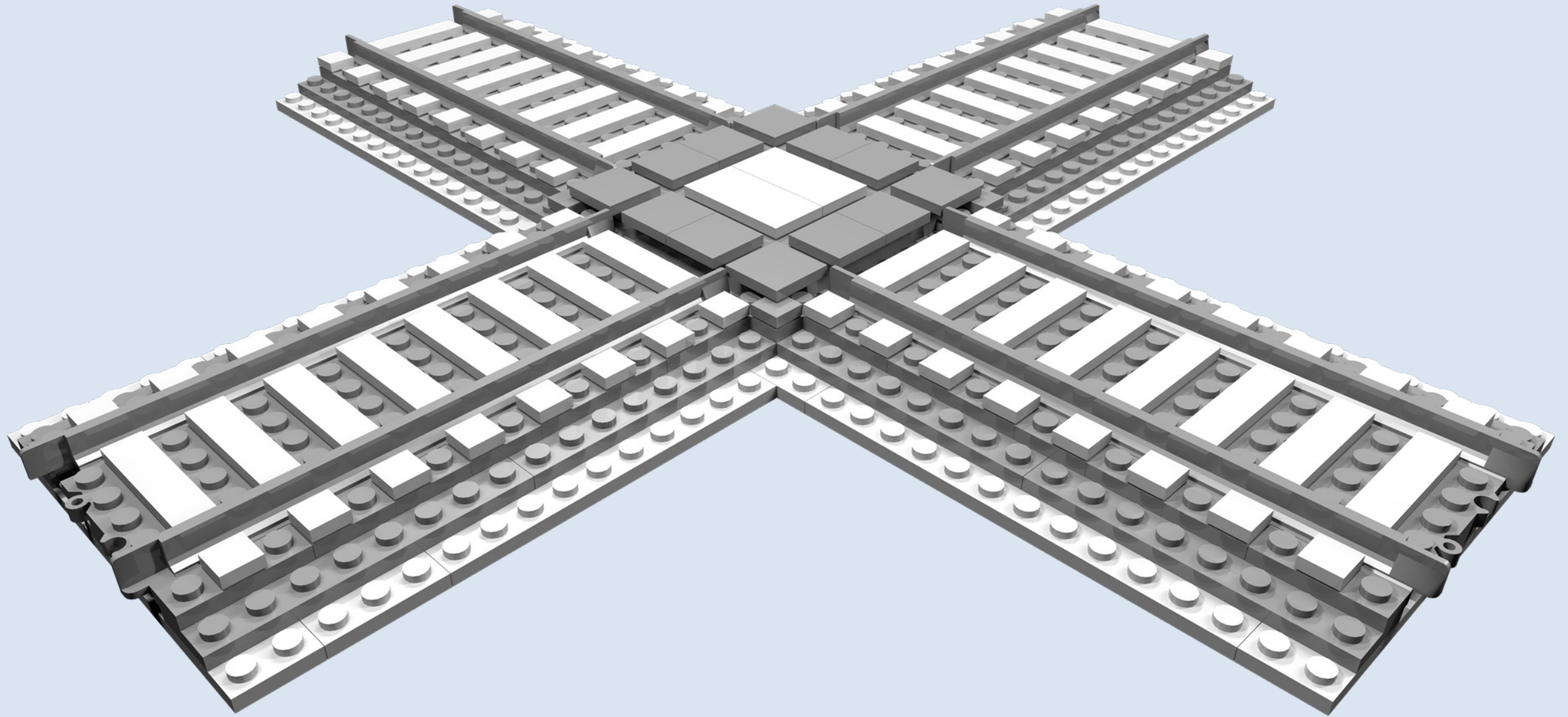

1

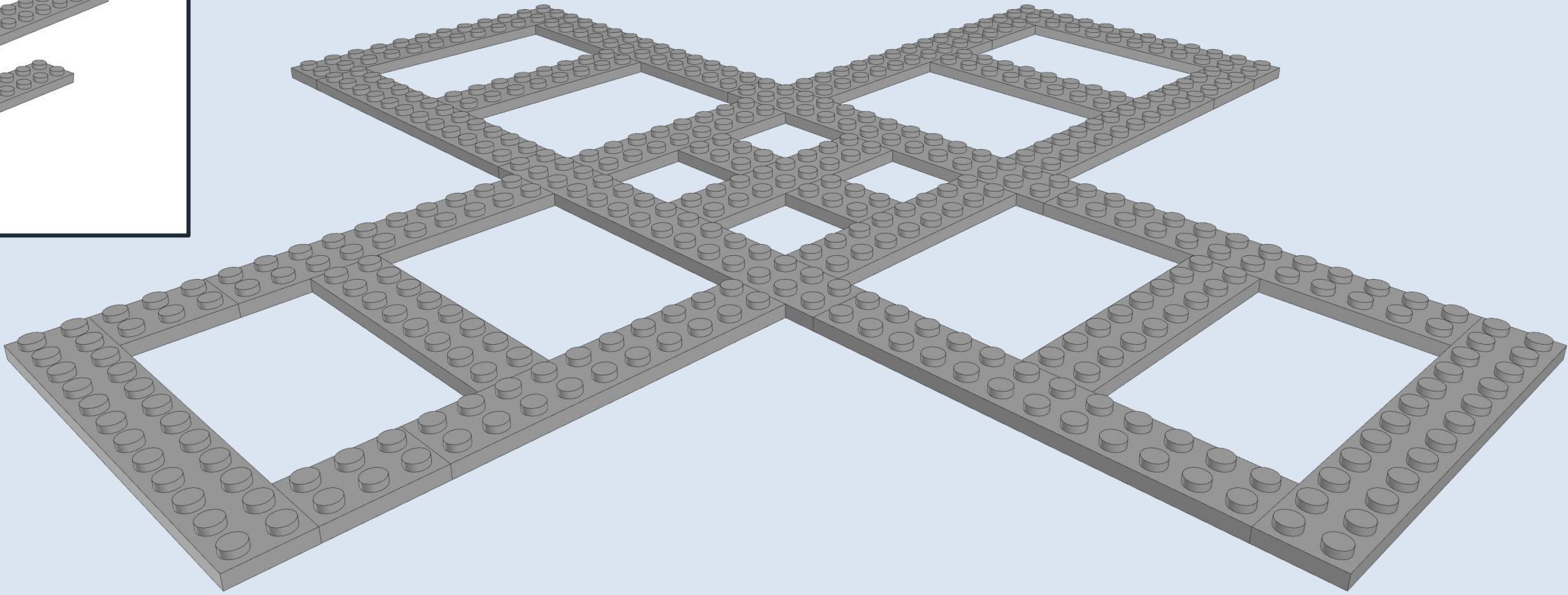

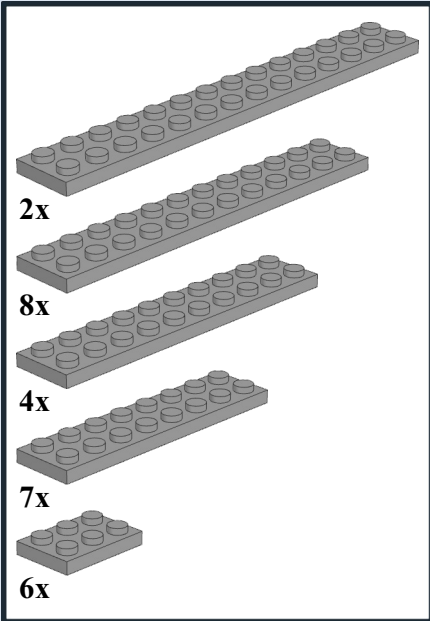
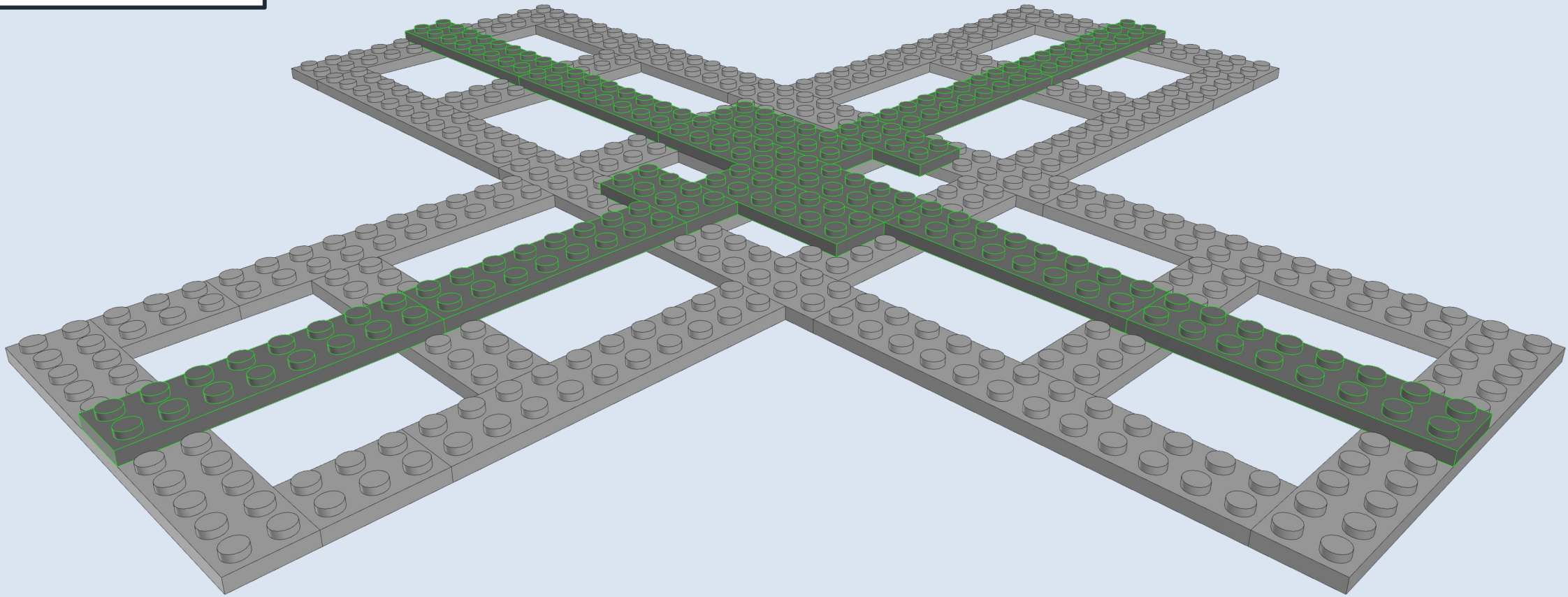
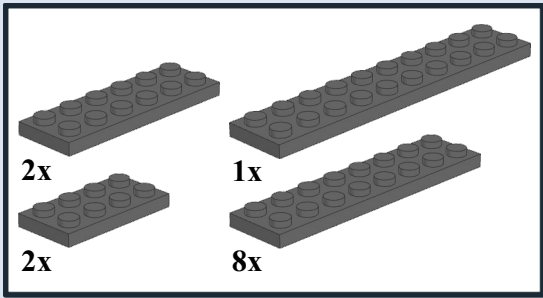

3

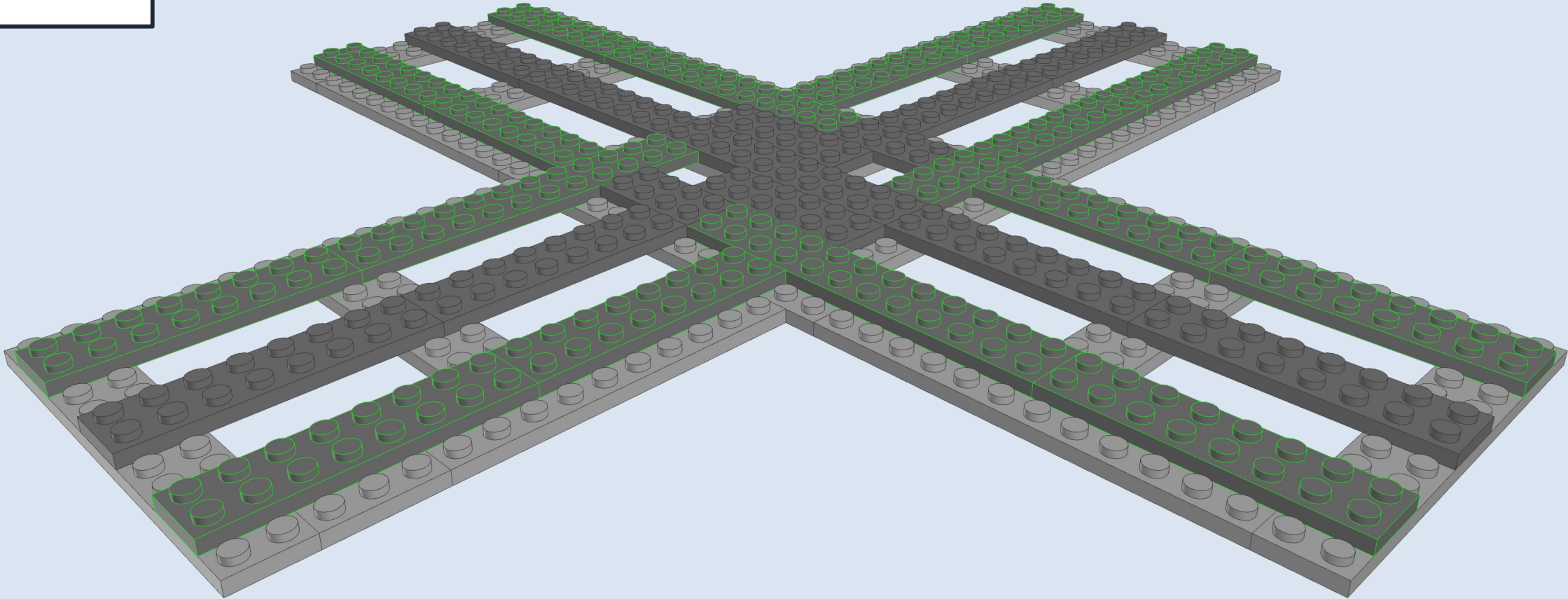
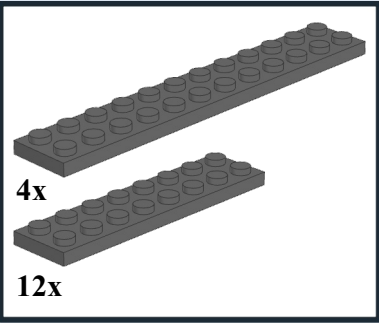

4

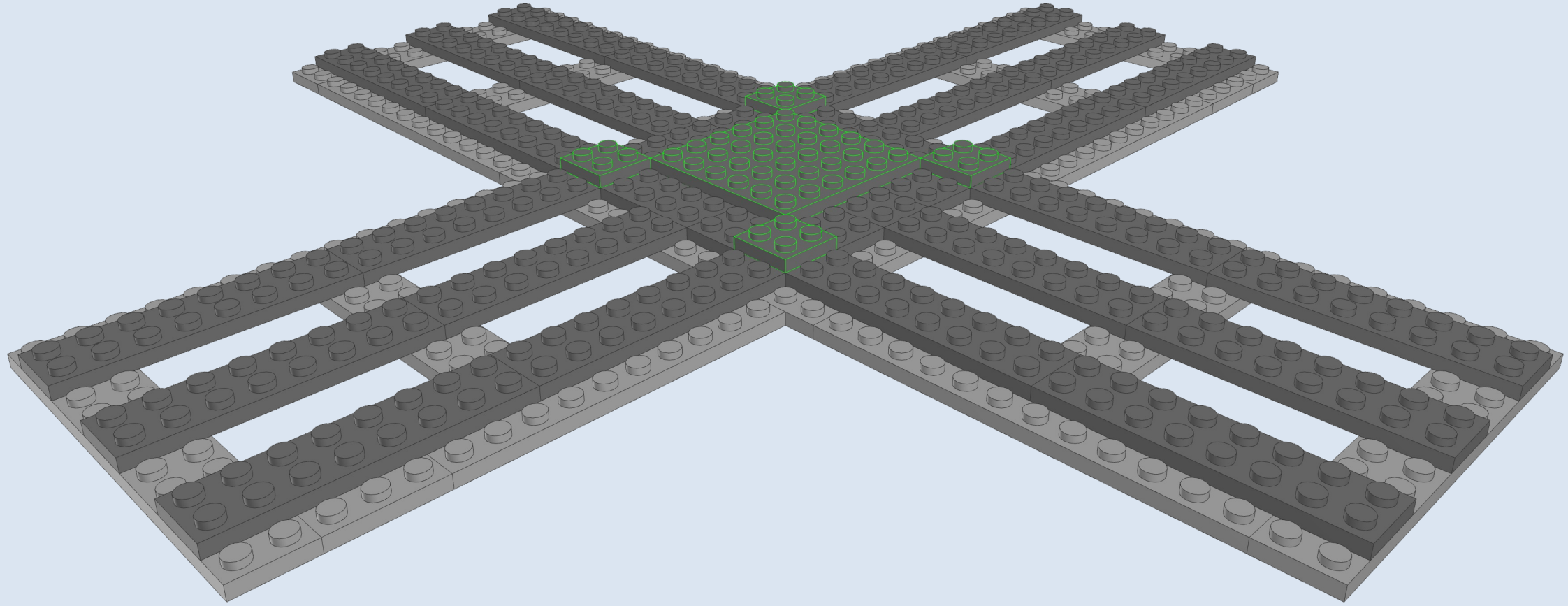
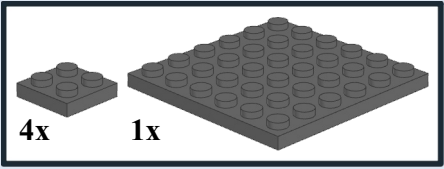

5

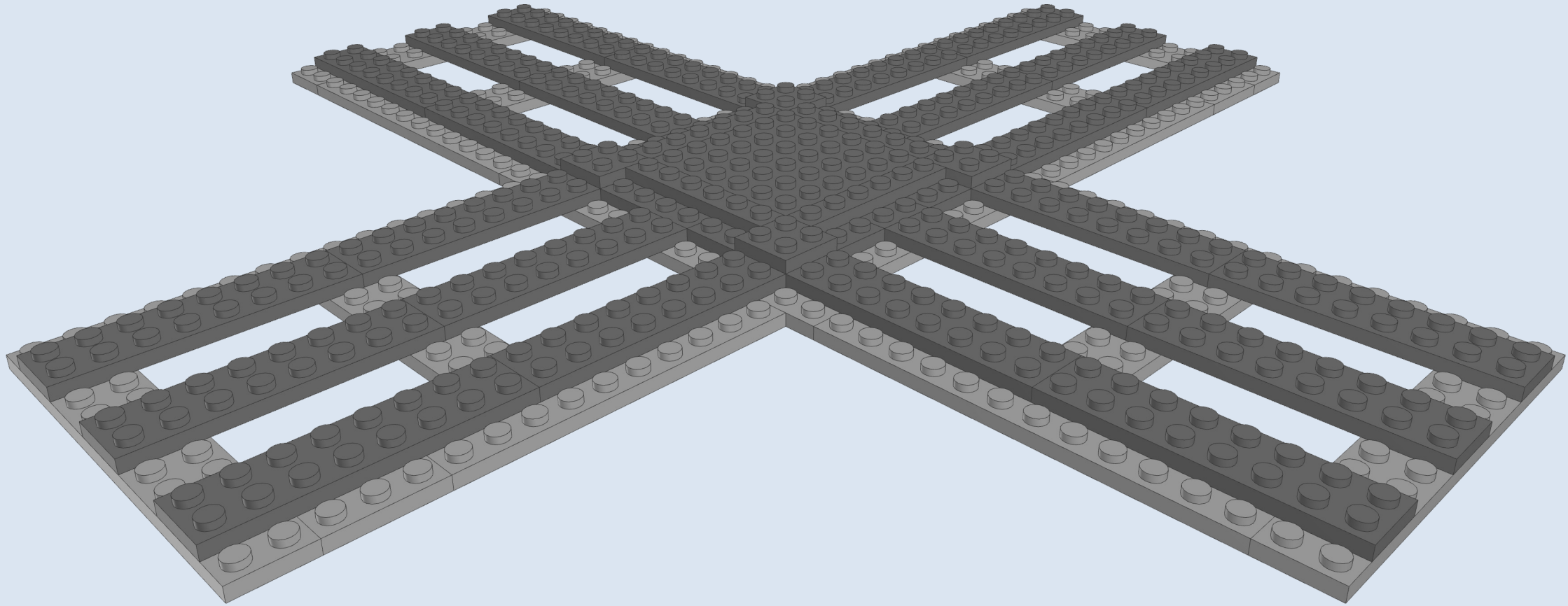
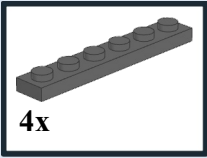

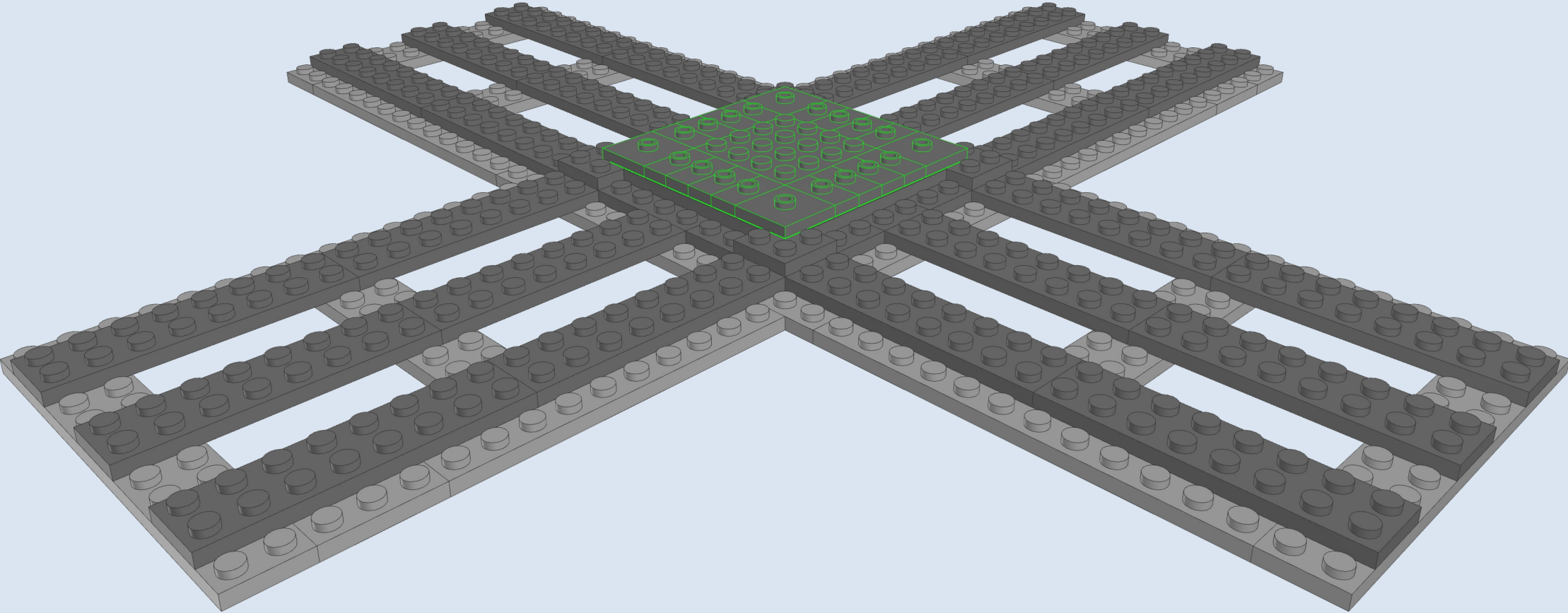
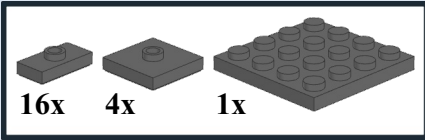

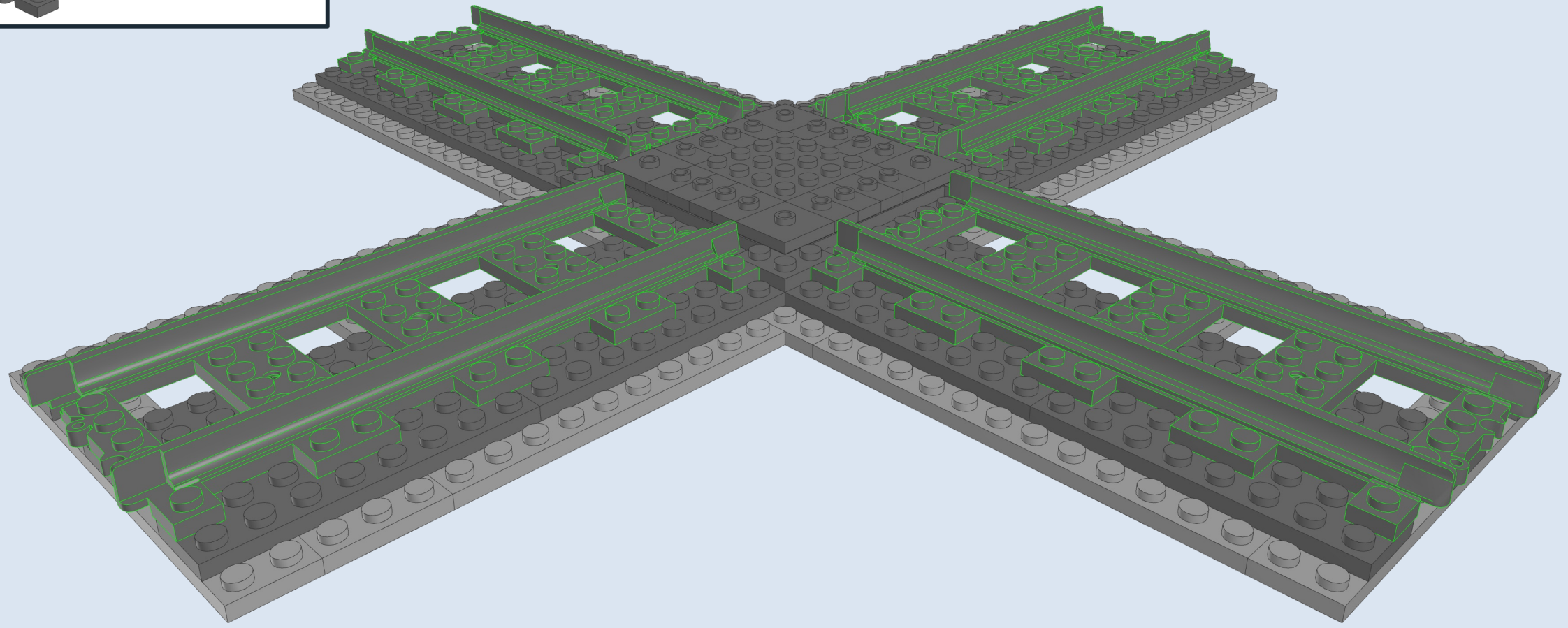
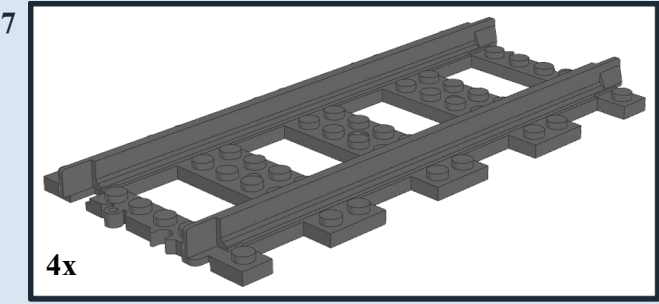



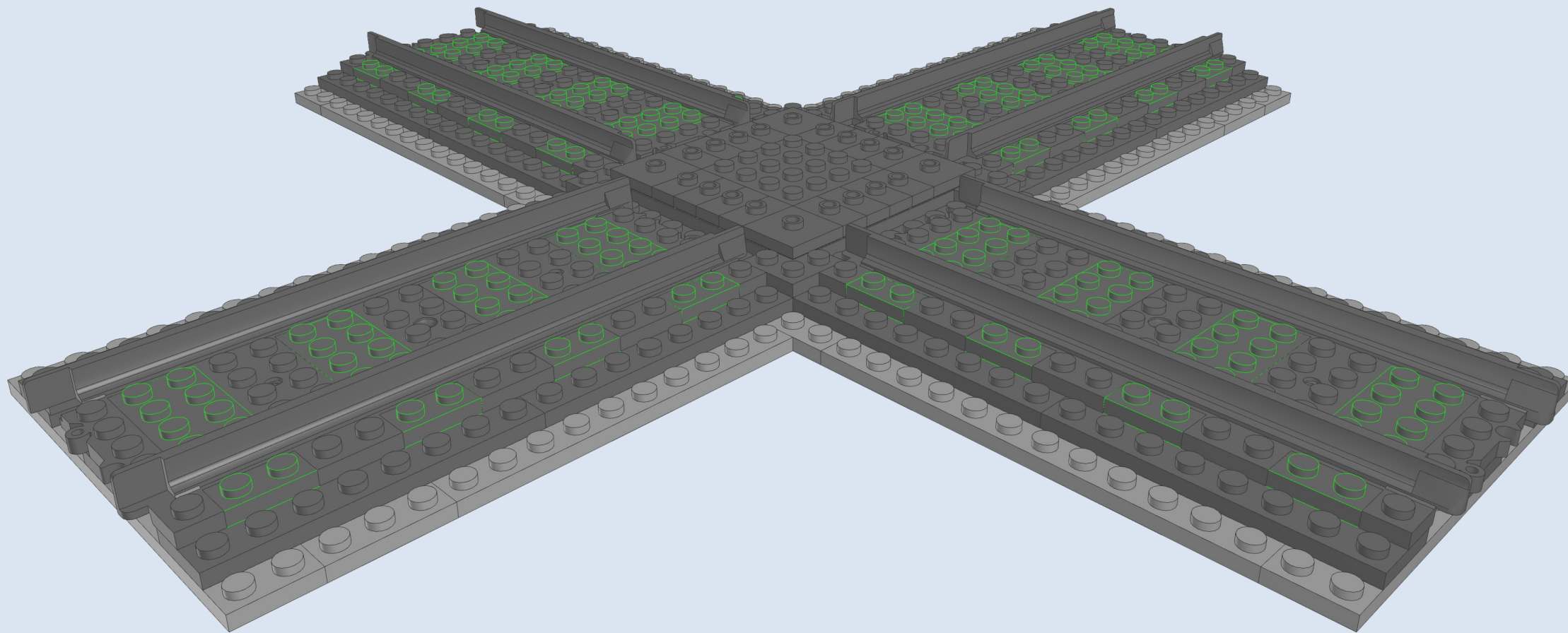
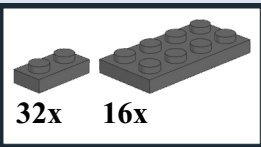

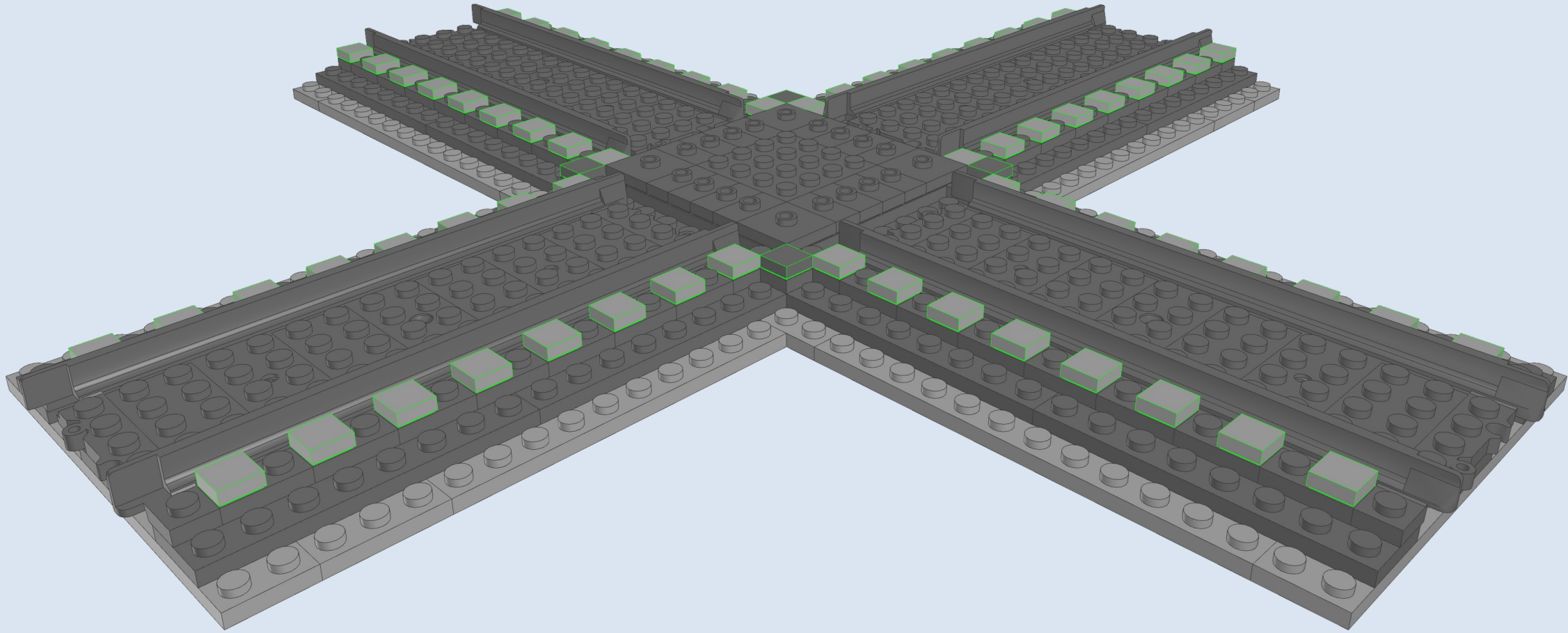
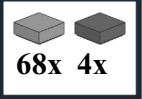

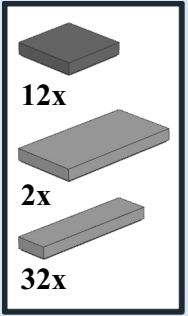

12x  
2x  
32x

This block contains a parts list for step 10. It lists three types of grey LEGO Technic parts: a 1x2 plate (12x), a 1x4 plate (2x), and a 1x10 plate (32x). Each part is shown with a green outline to indicate its shape and size.

