

Single Axle Boogie

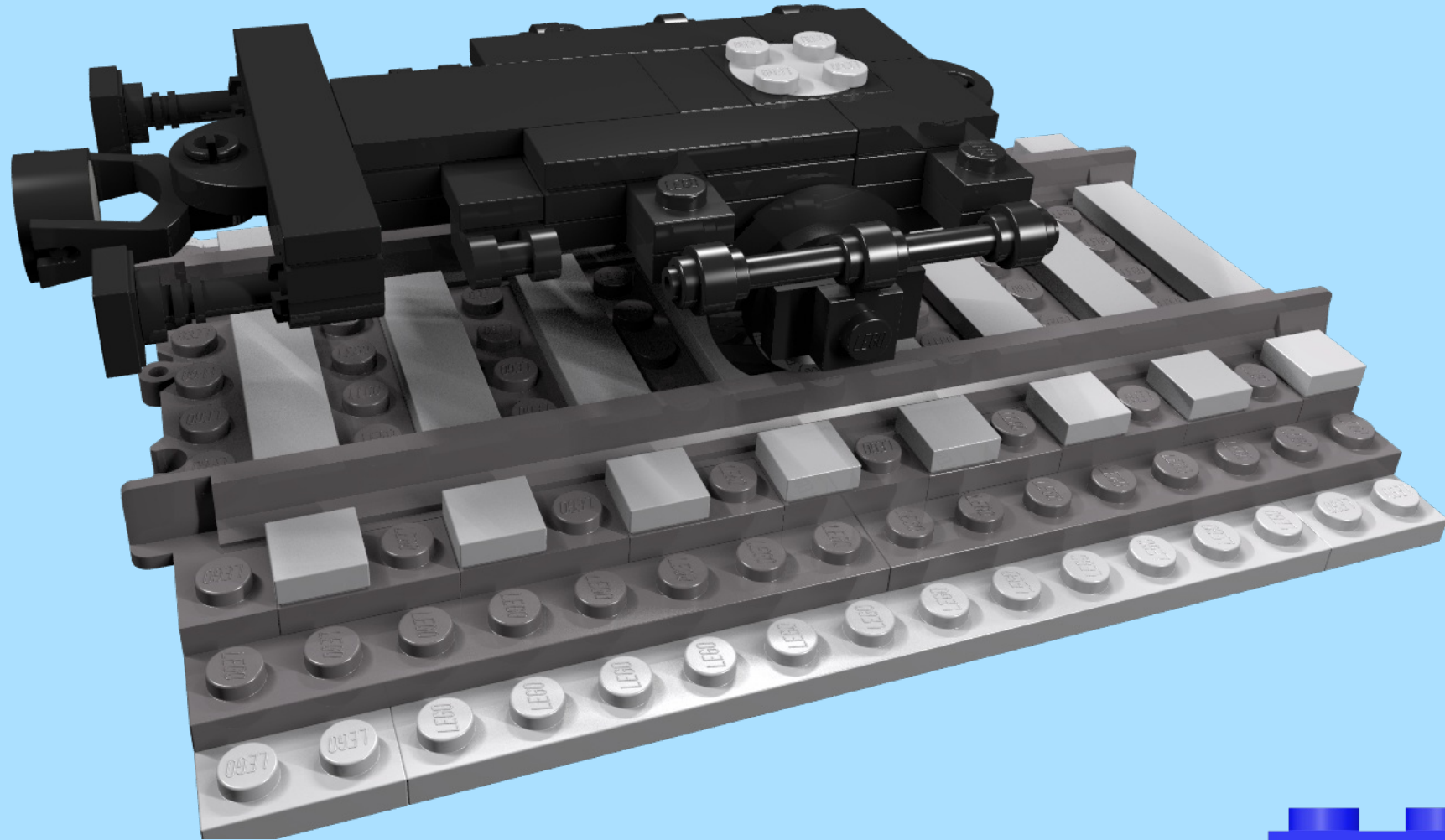

Original Design by Dennis Tomsen
Modified to use ballbearings by me

INSTRUCTION BY
KNUD ALBRECHTSEN
www.snakebyte.dk/lego

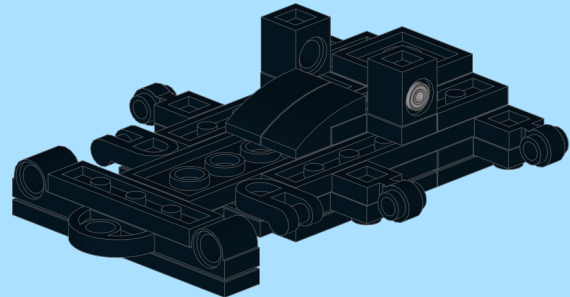
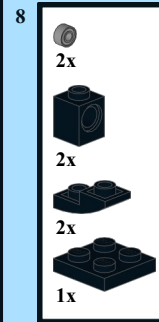
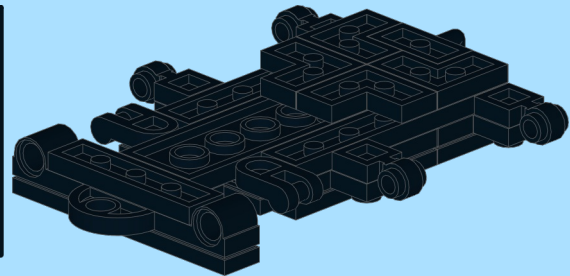
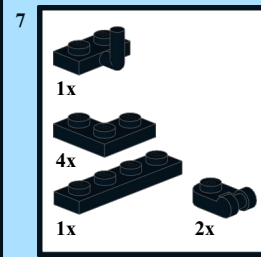
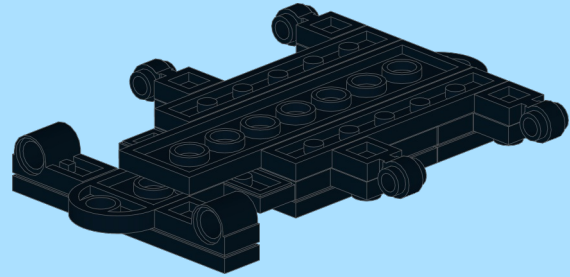
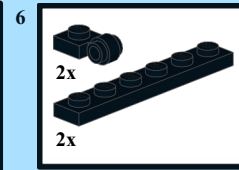
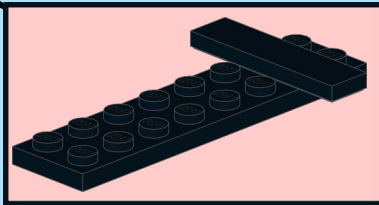
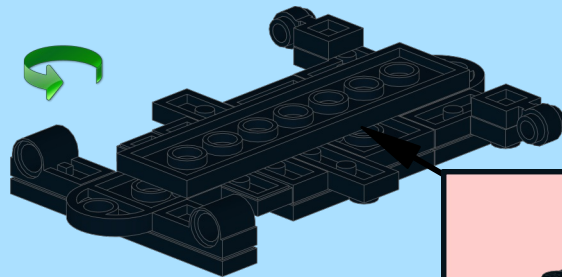
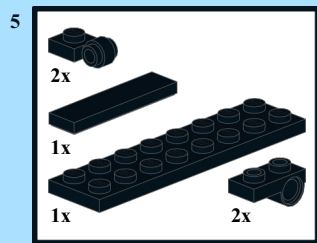
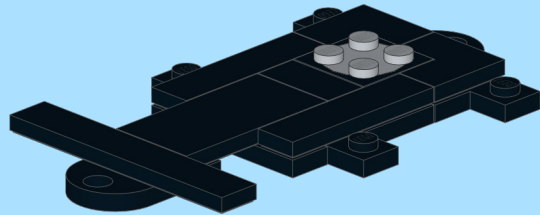
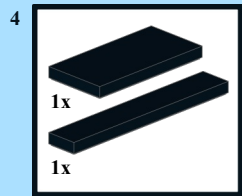
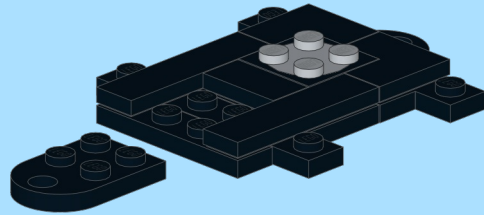
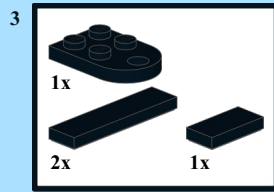
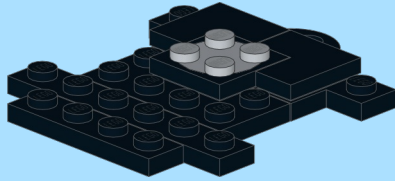
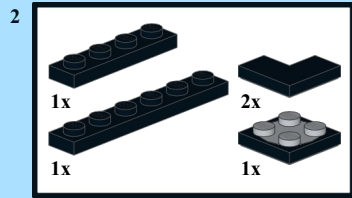
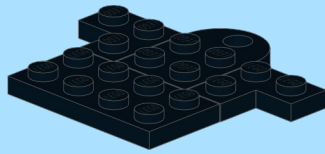
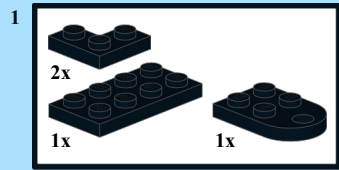

9

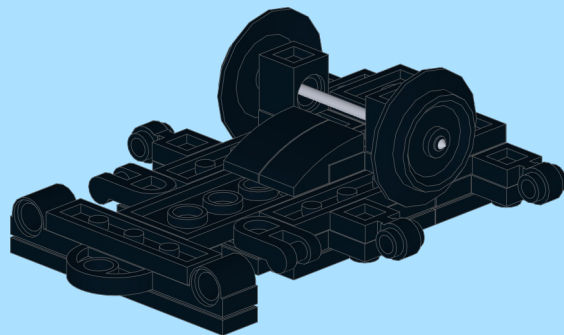
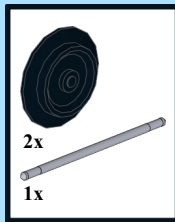

10

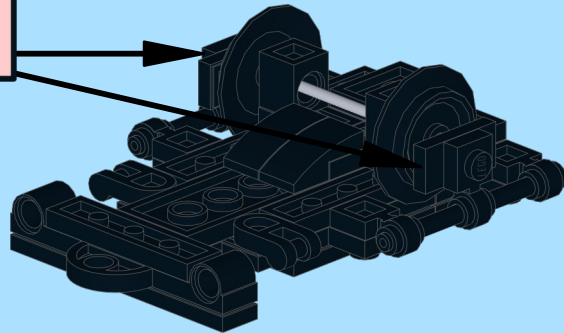
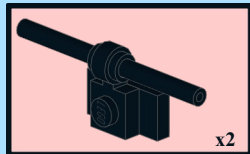
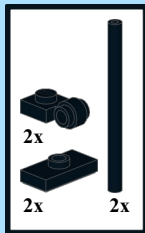

11

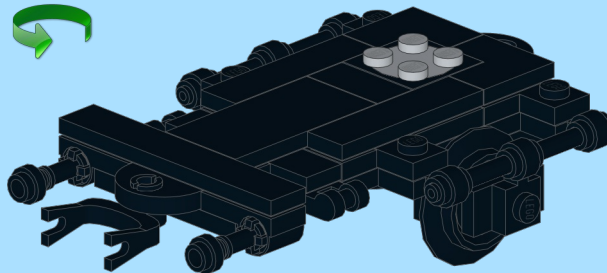
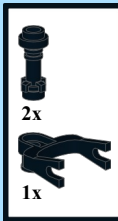

12

