

Moduverse Roadplate v5 Alternate with narrowing

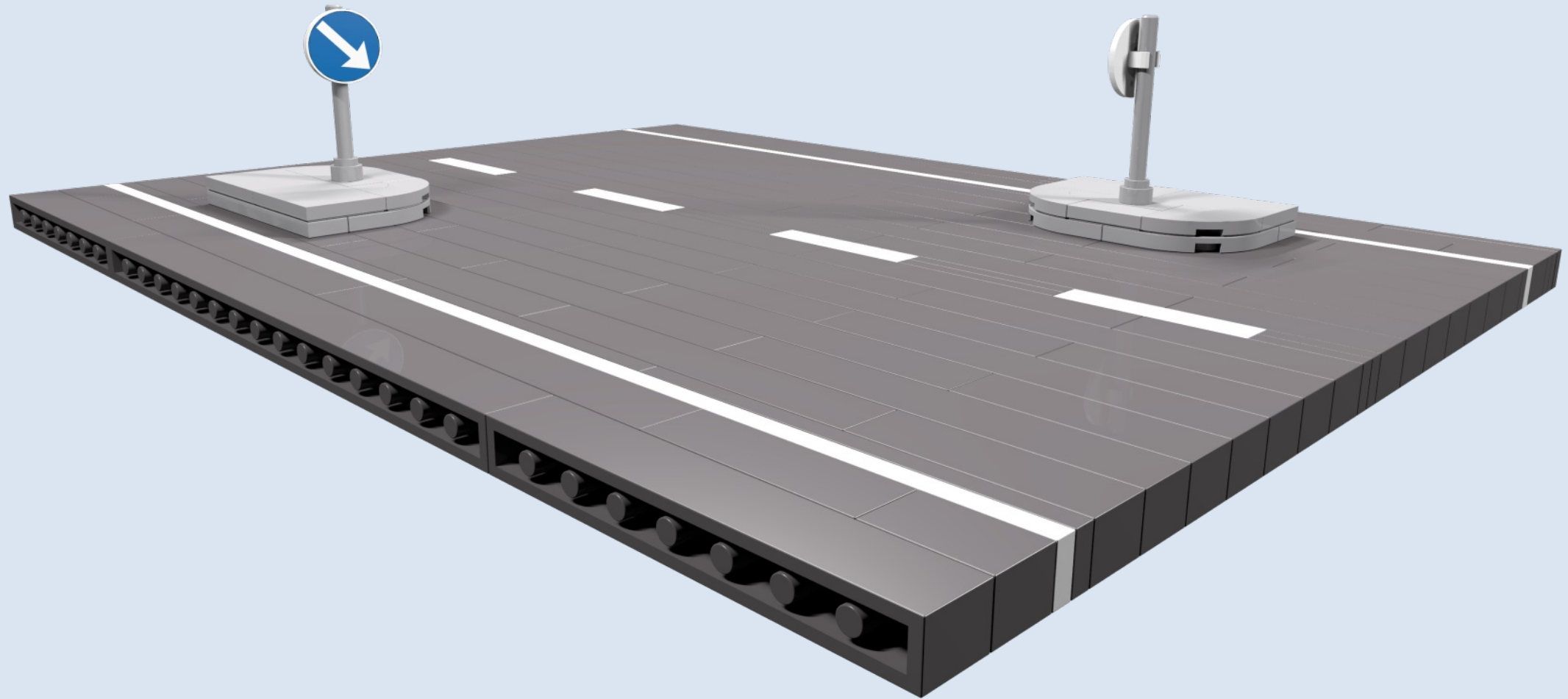

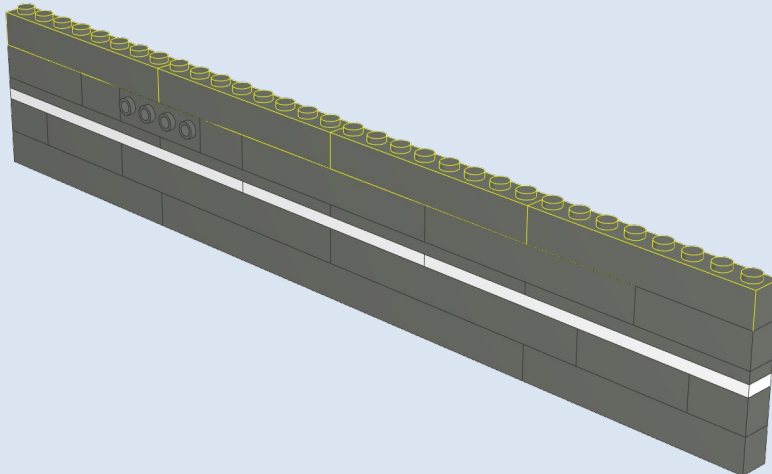

7

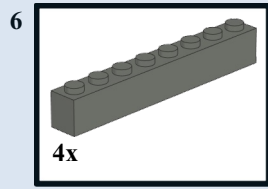
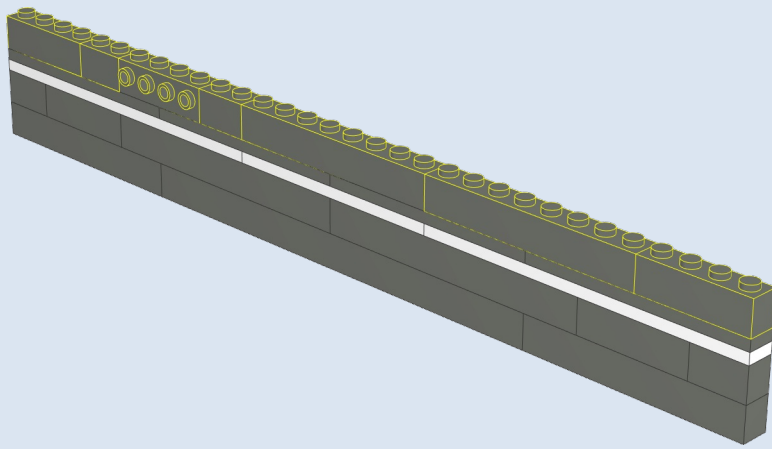
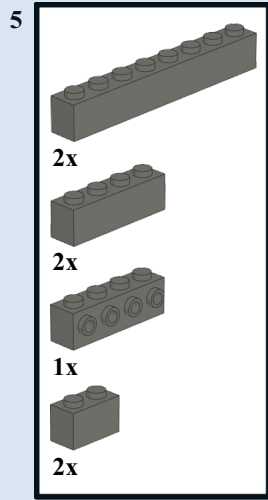
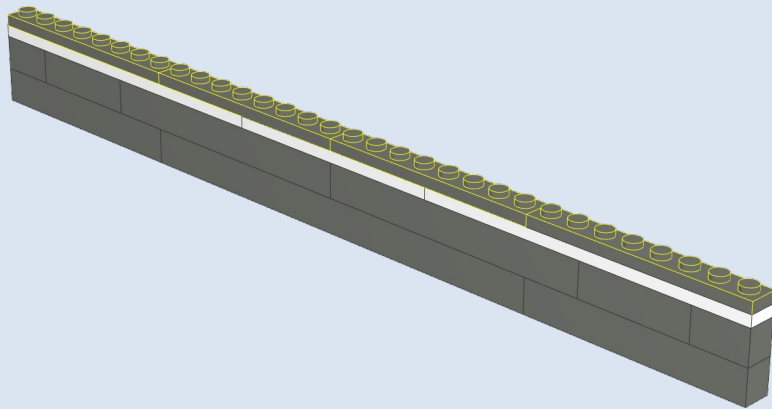
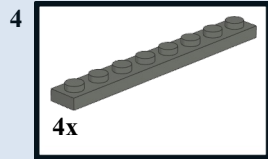
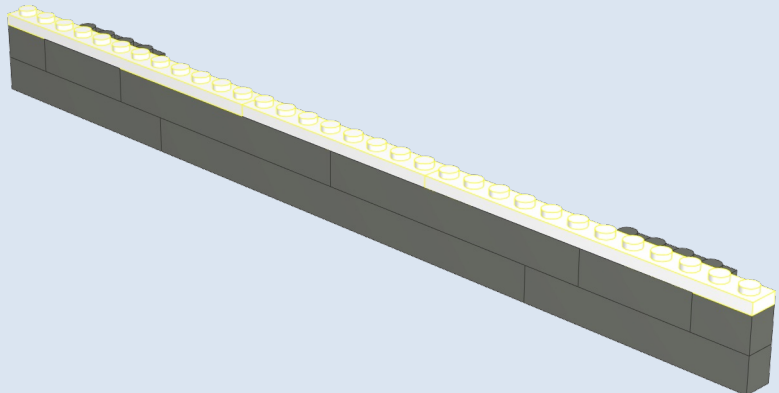
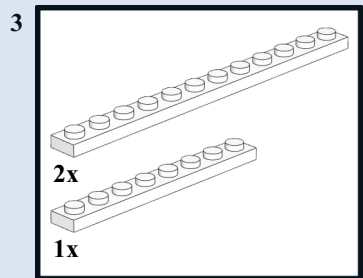
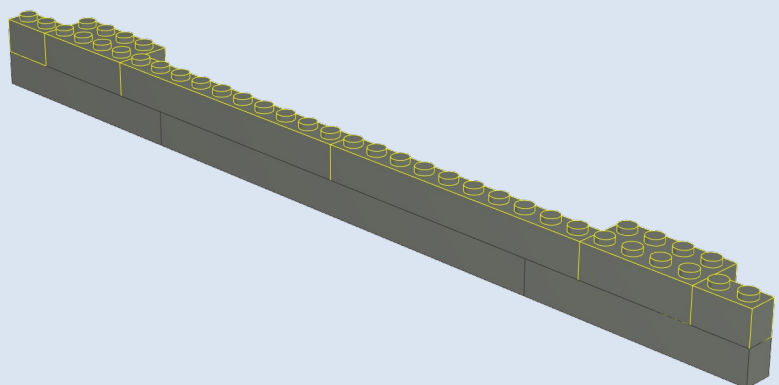
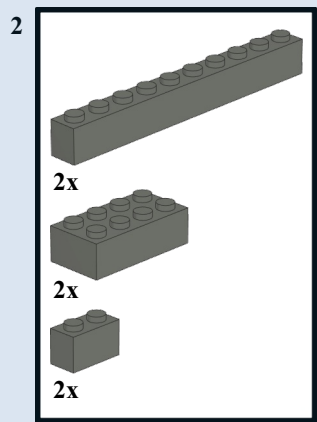
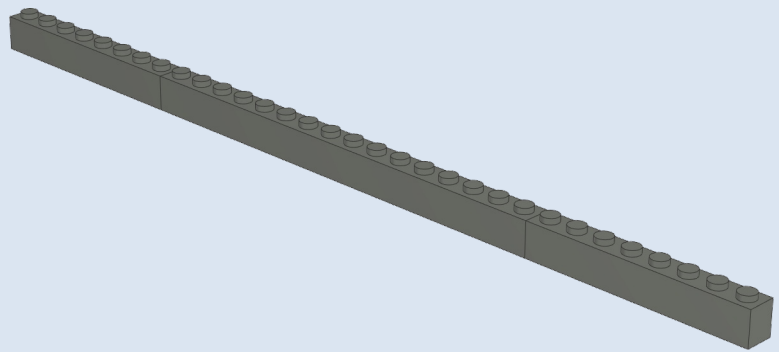
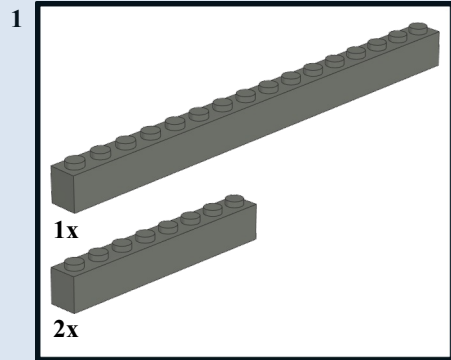
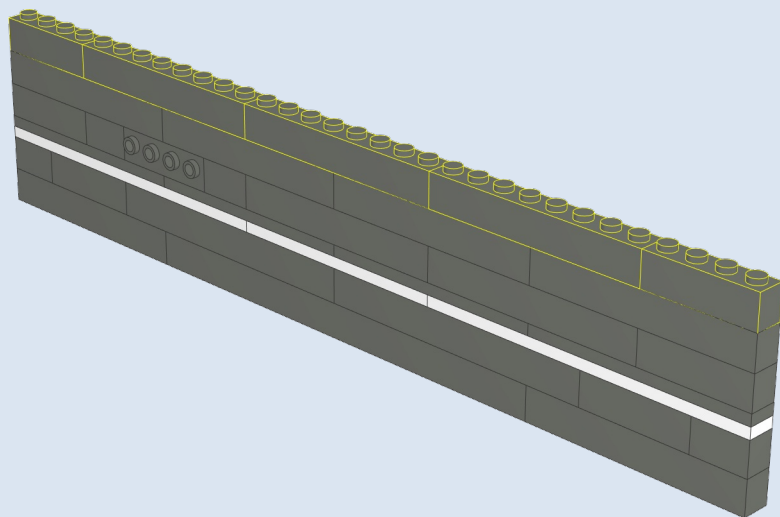
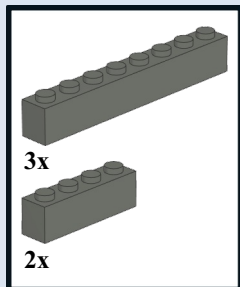

8

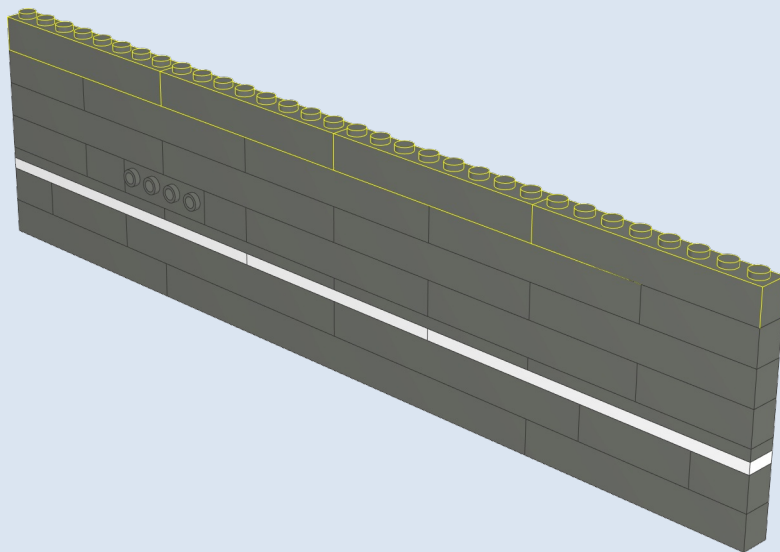
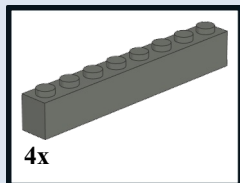

9

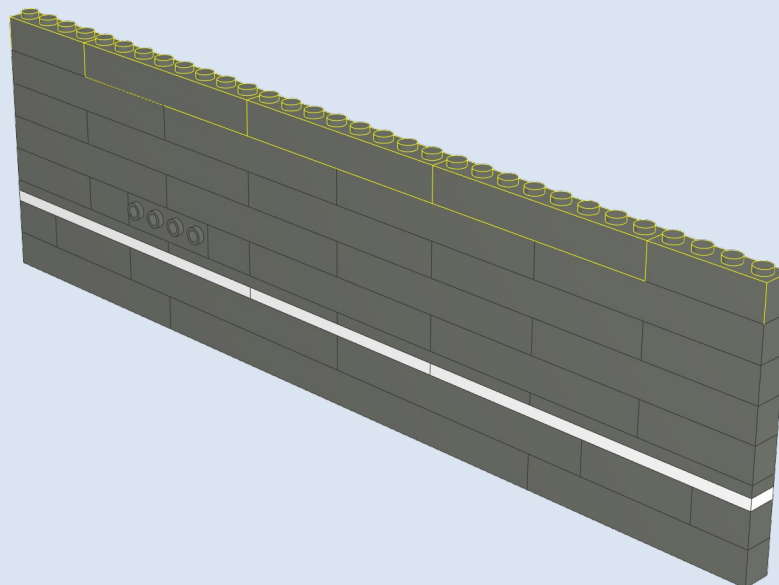
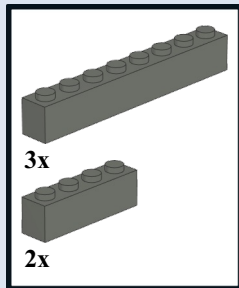

10

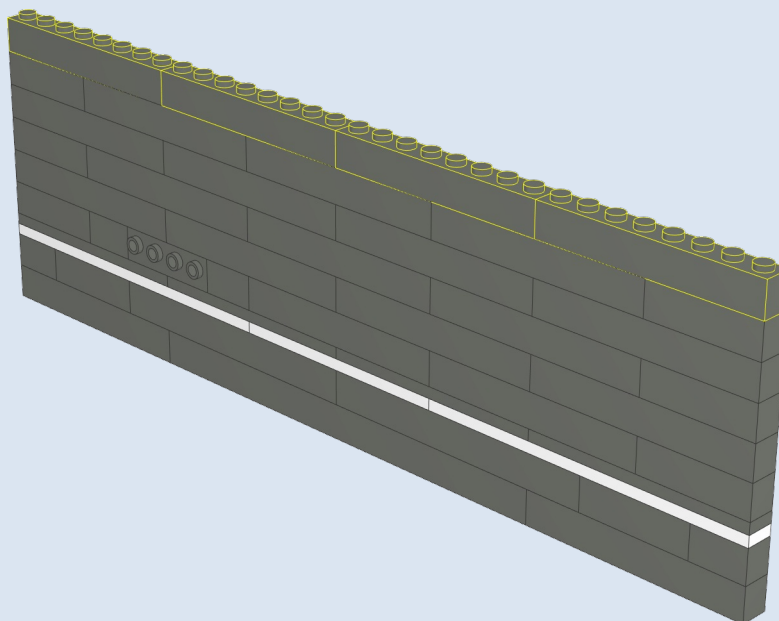
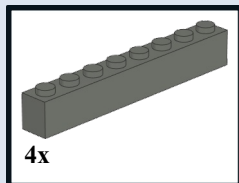

11

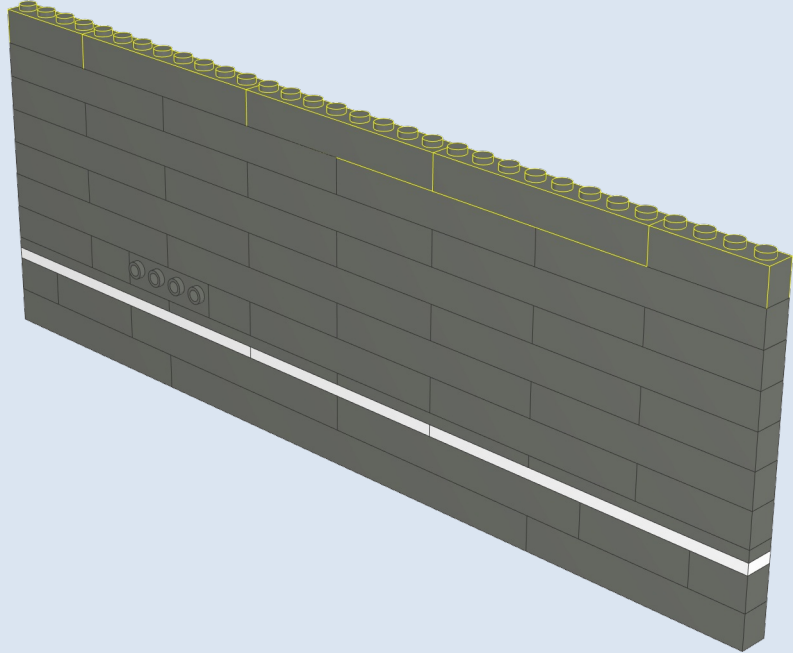
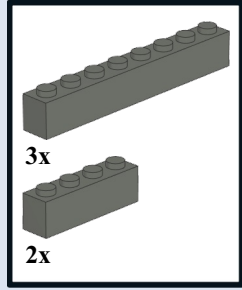

13

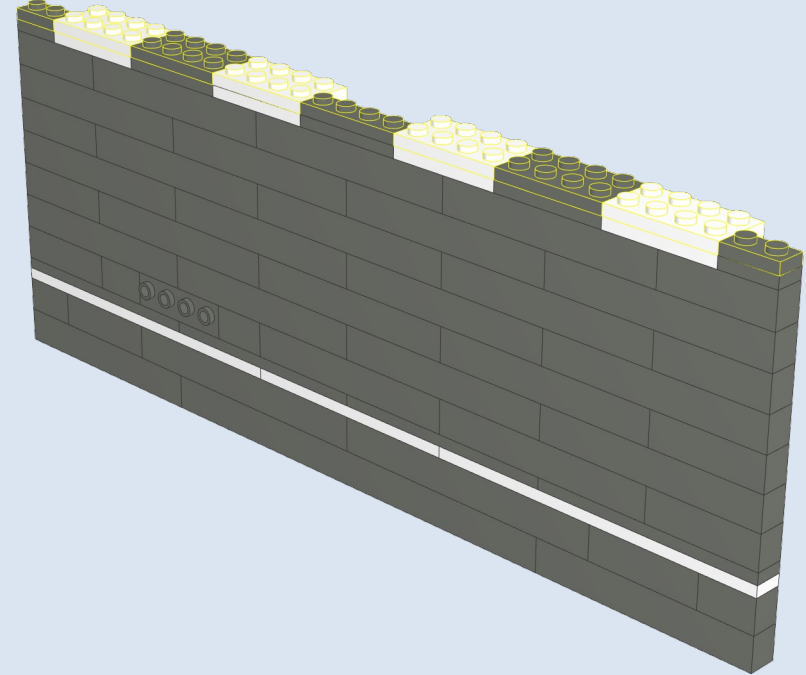
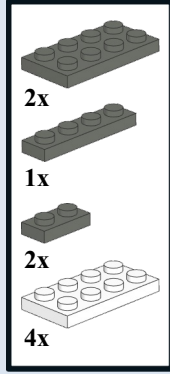

12

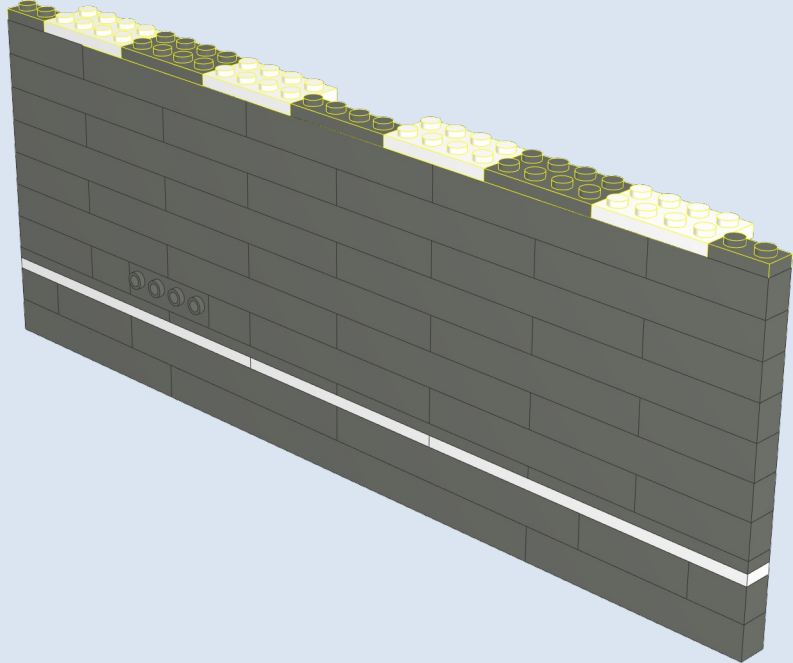
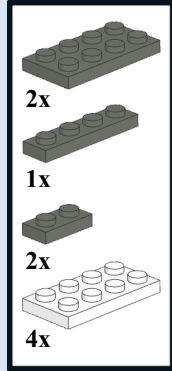

14

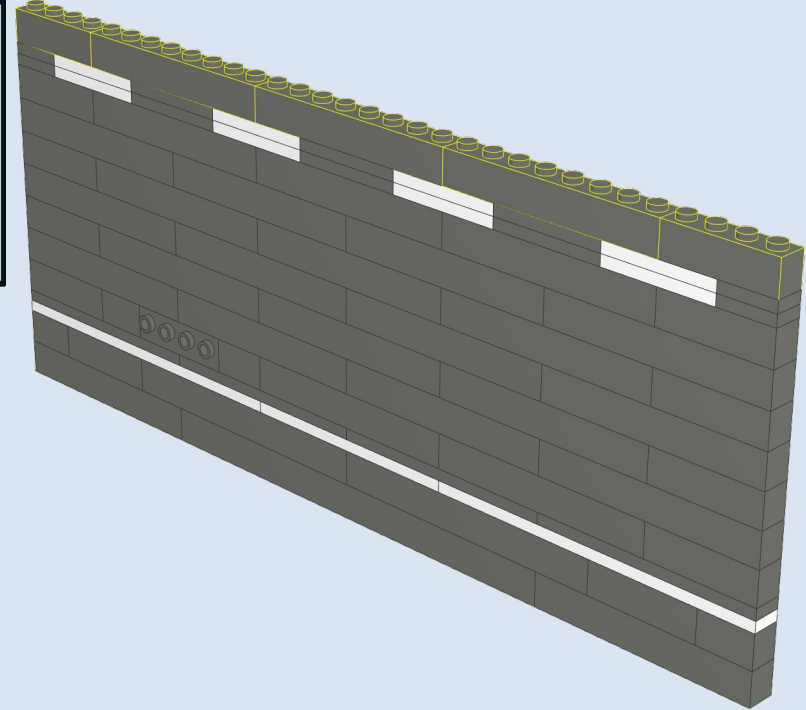
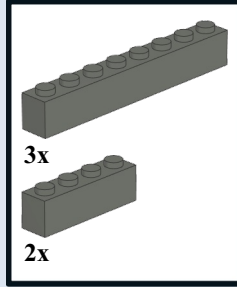

15

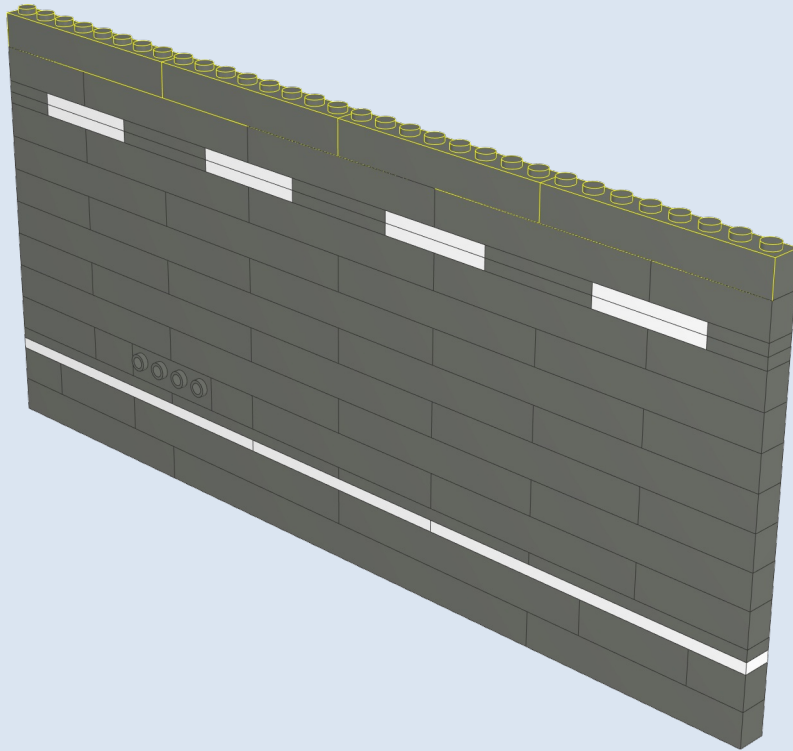
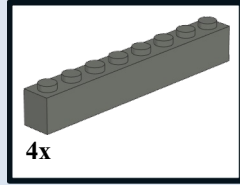

16

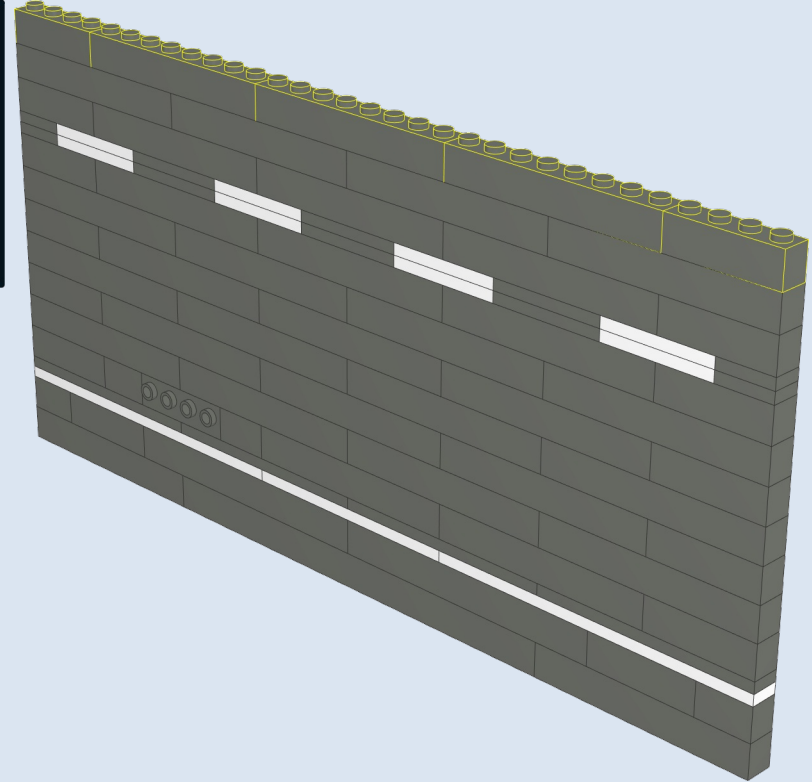
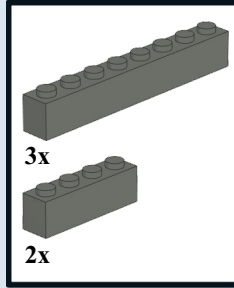

17

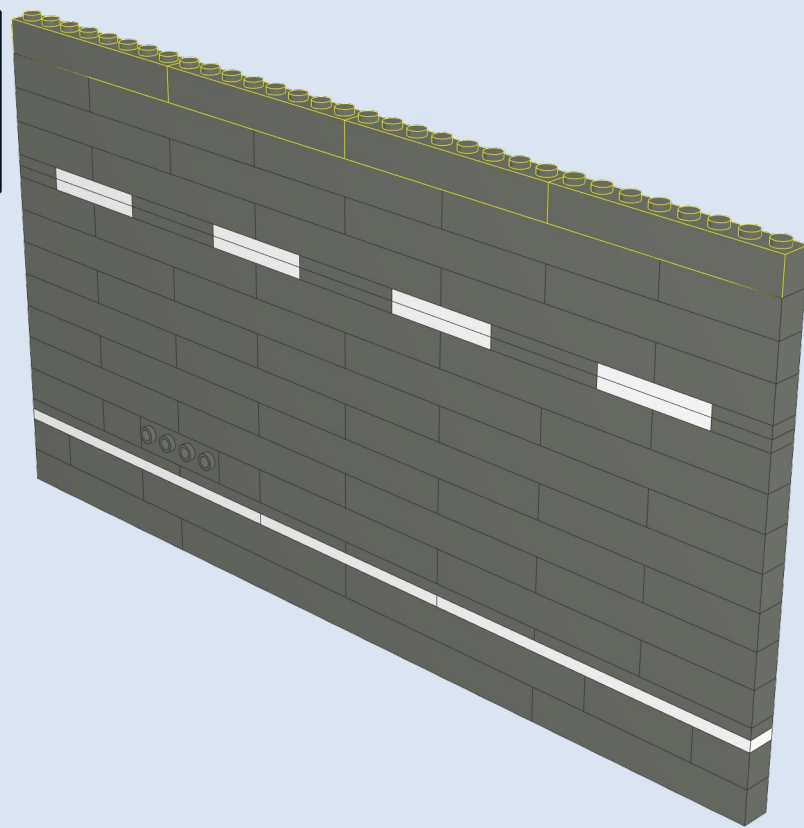
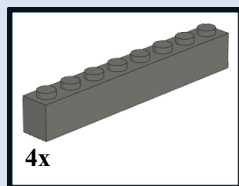

18

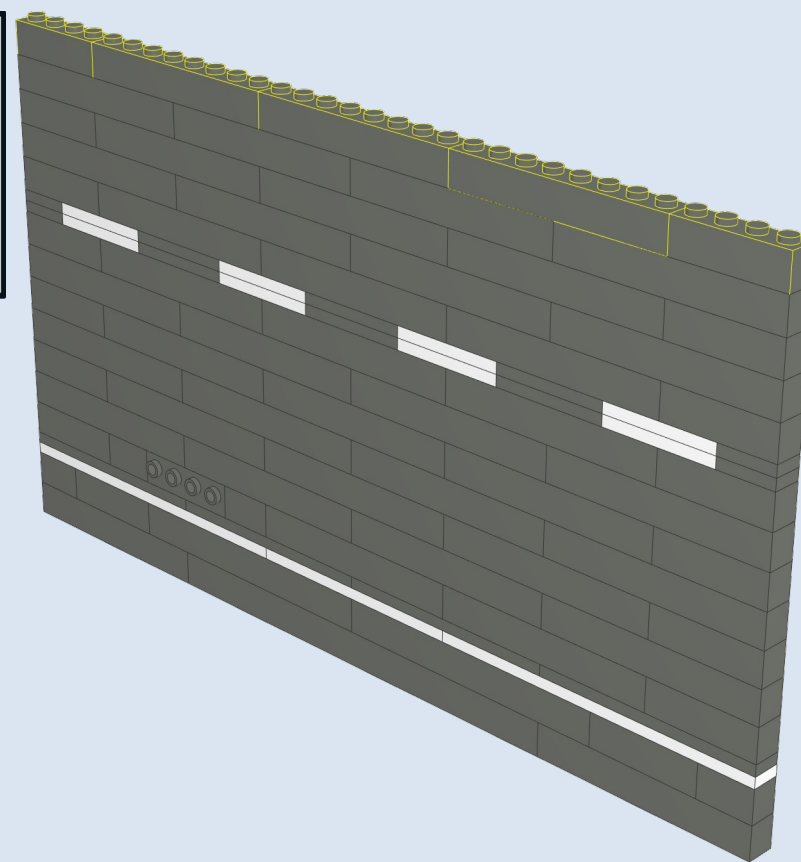
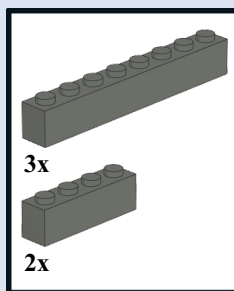

19

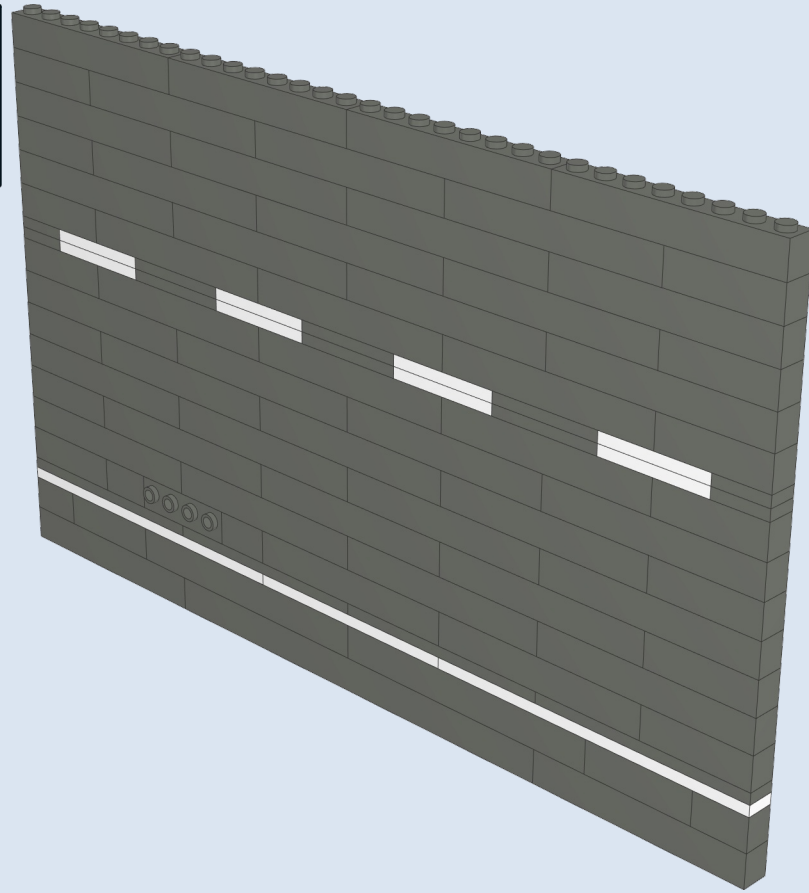
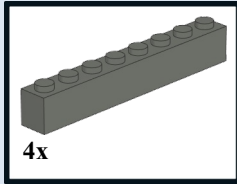

20

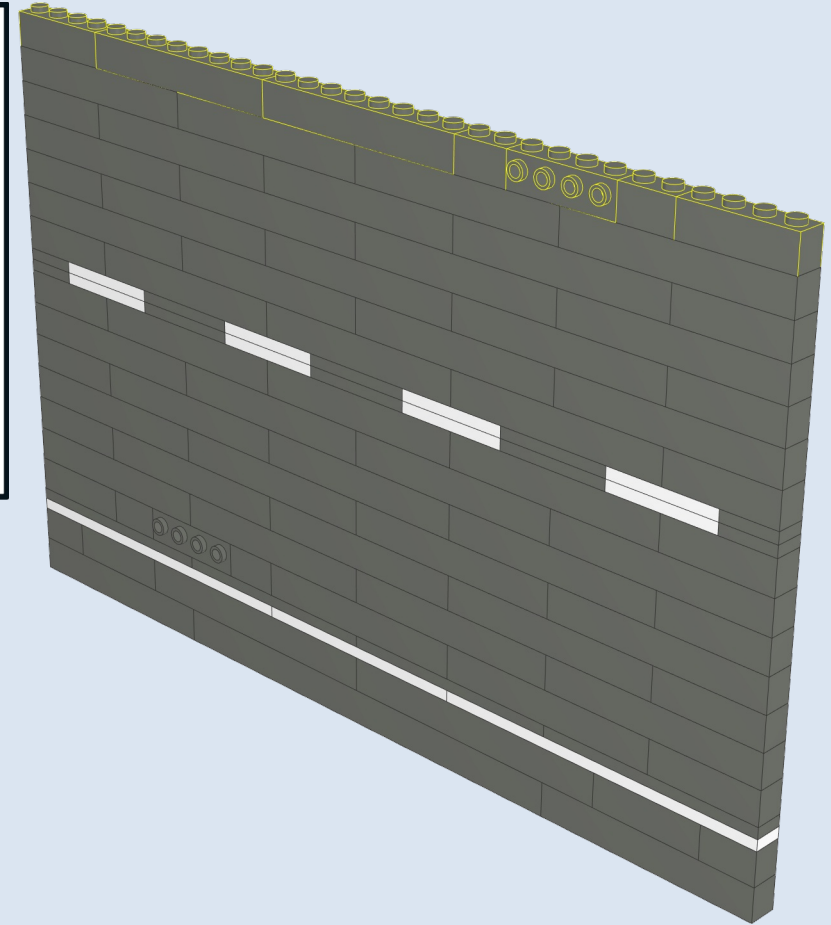
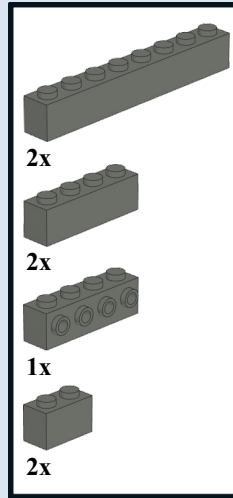

21

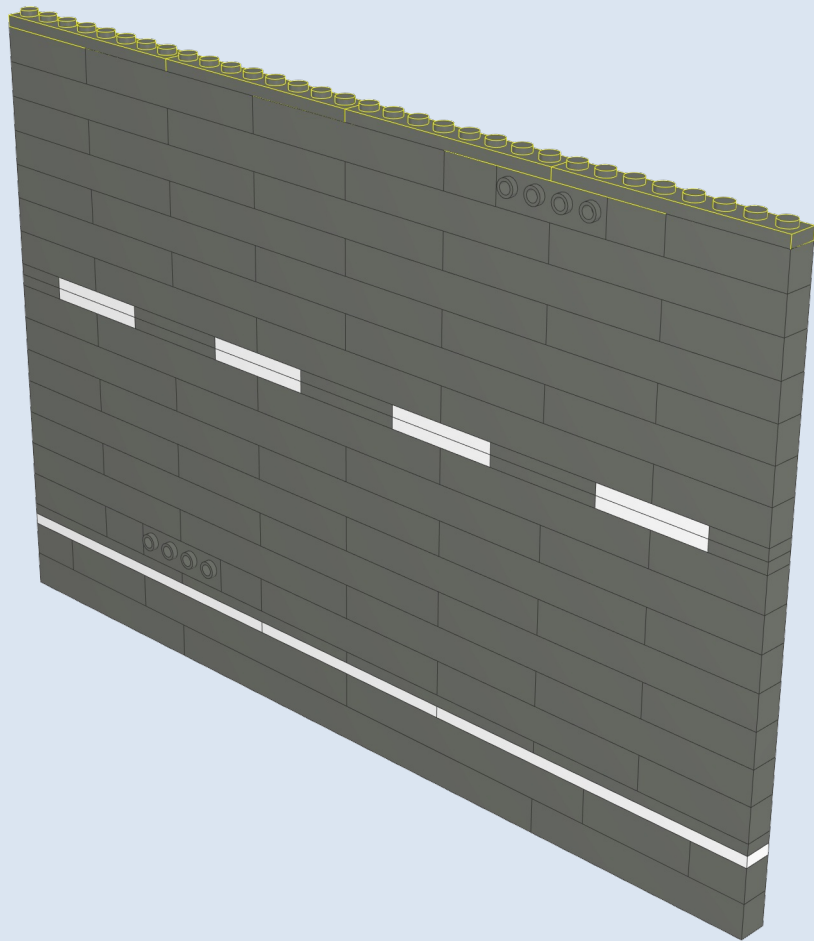
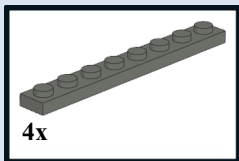

22

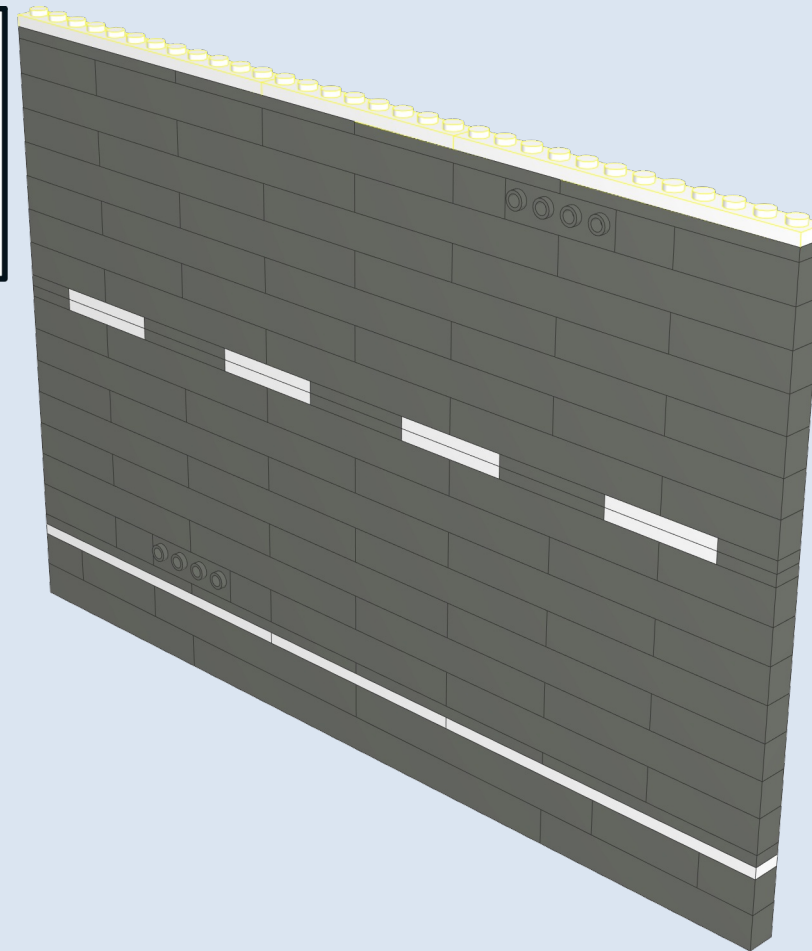
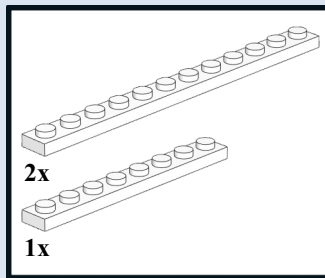

23

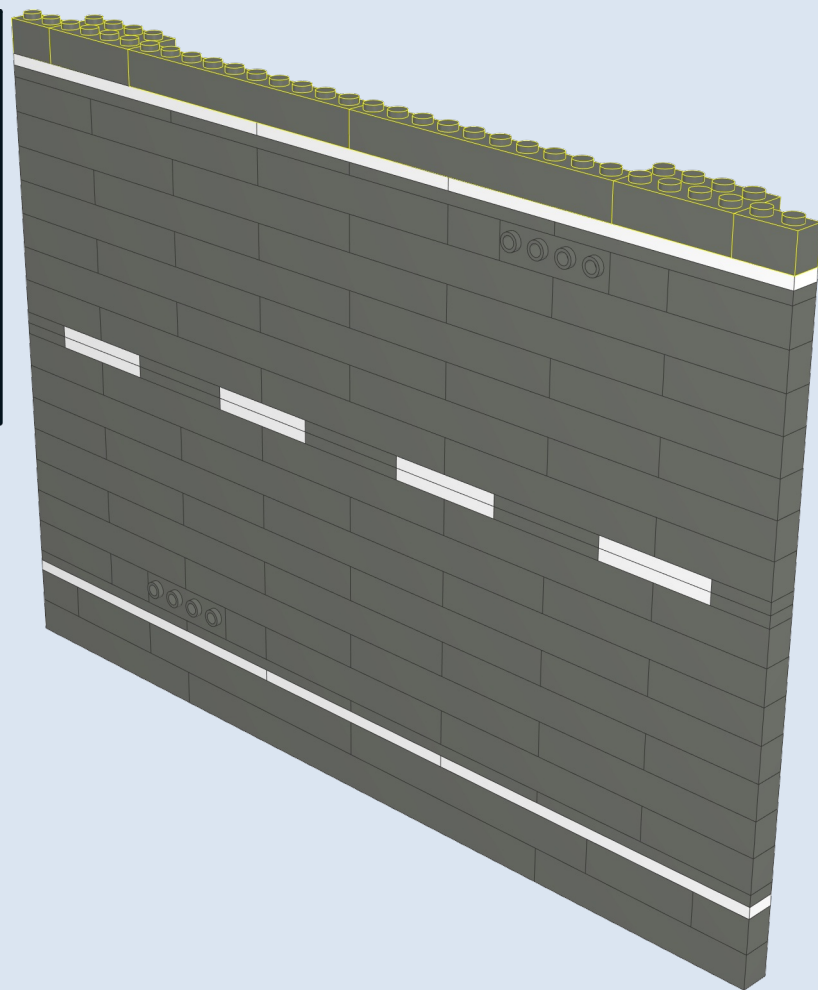
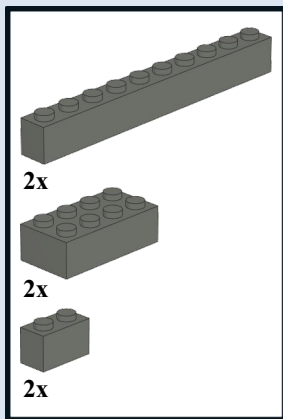

24

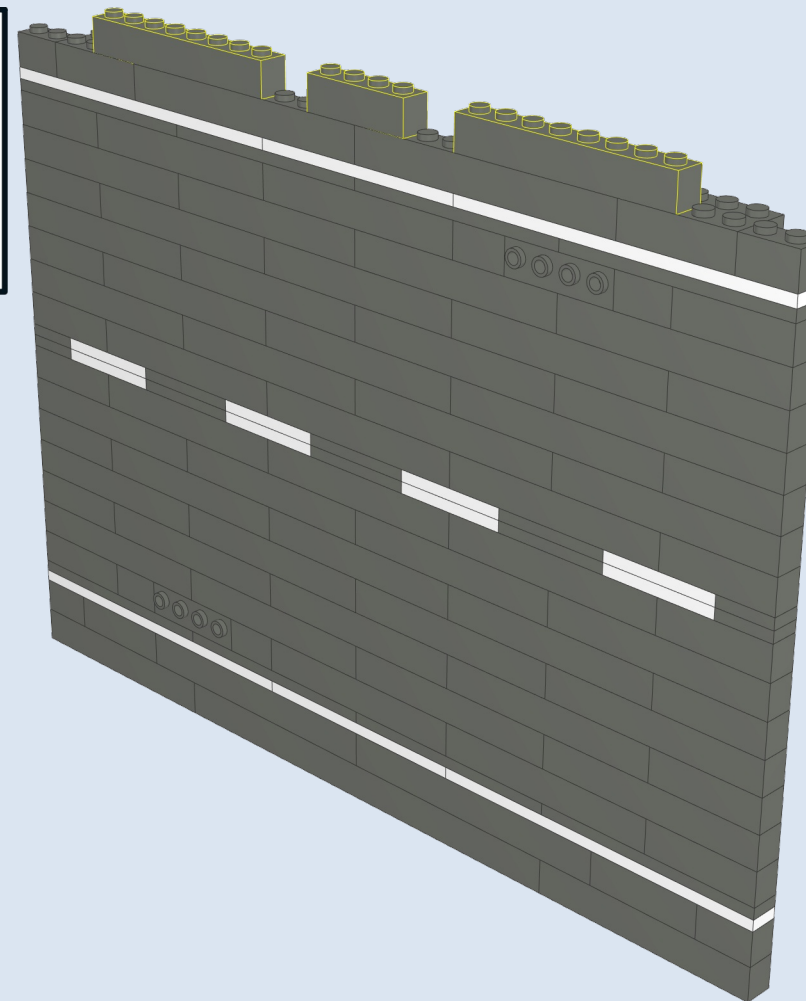
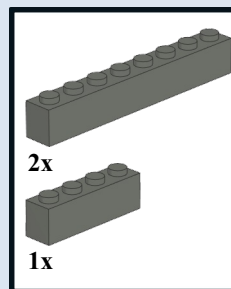

25

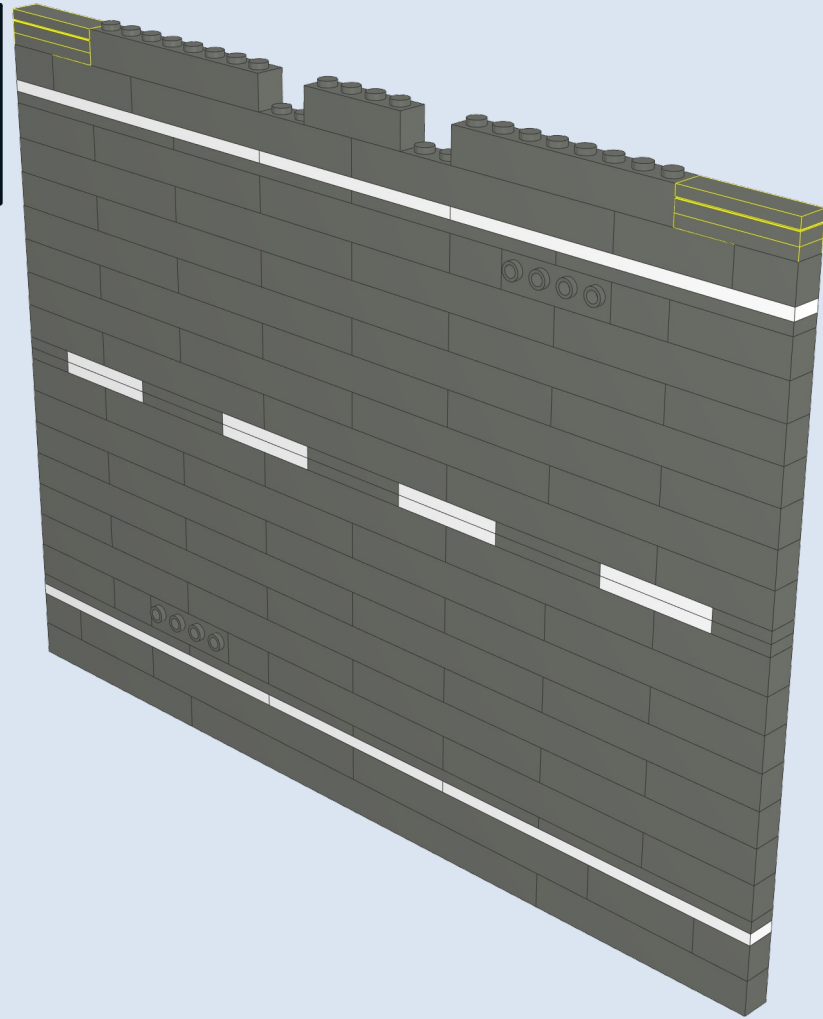
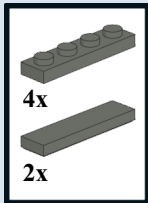

26

