

Bricklays Bank

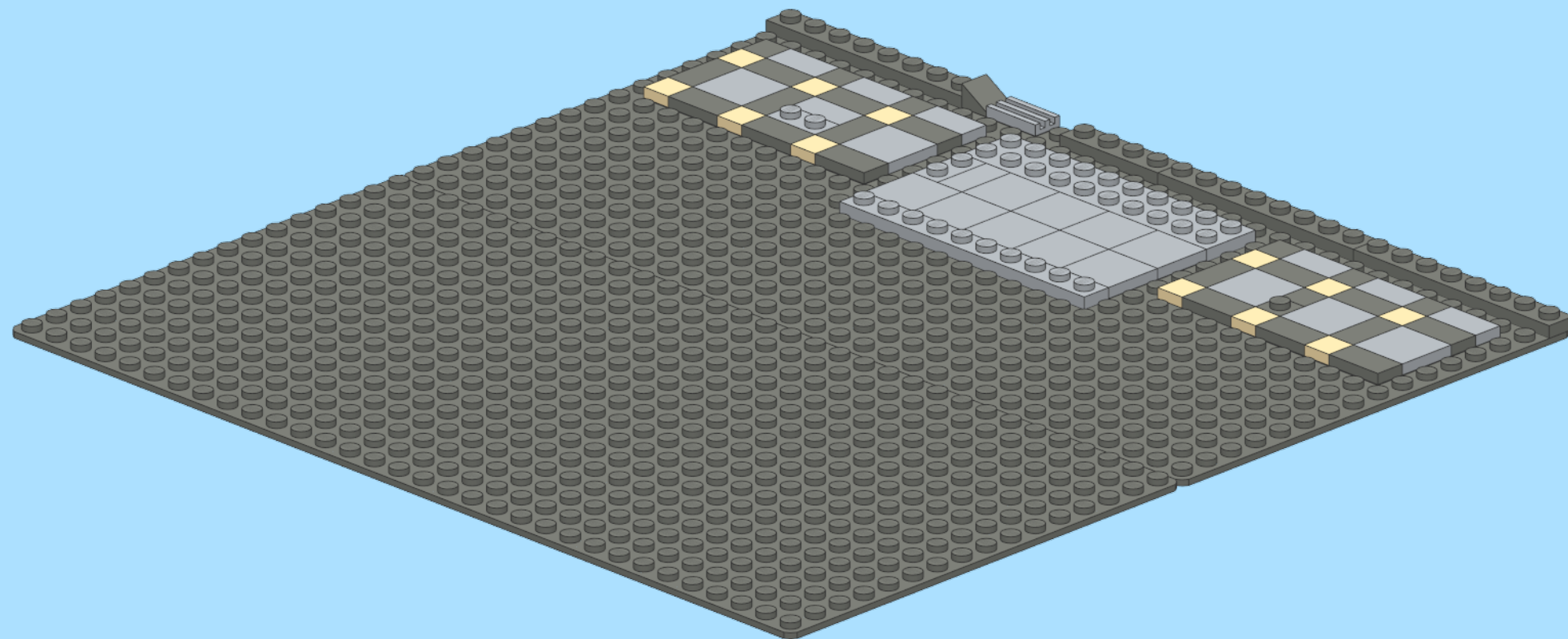

Design By Ryan Taggart

INSTRUCTION BY
KNUD ALBRECHTSEN
www.snakebyte.dk/lego

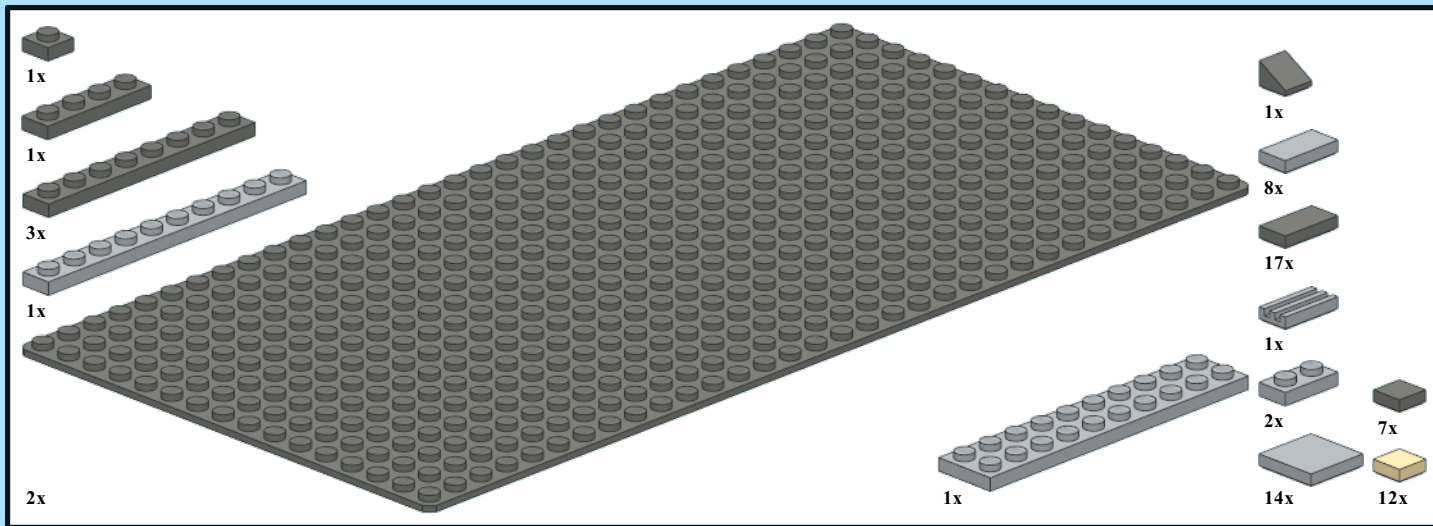

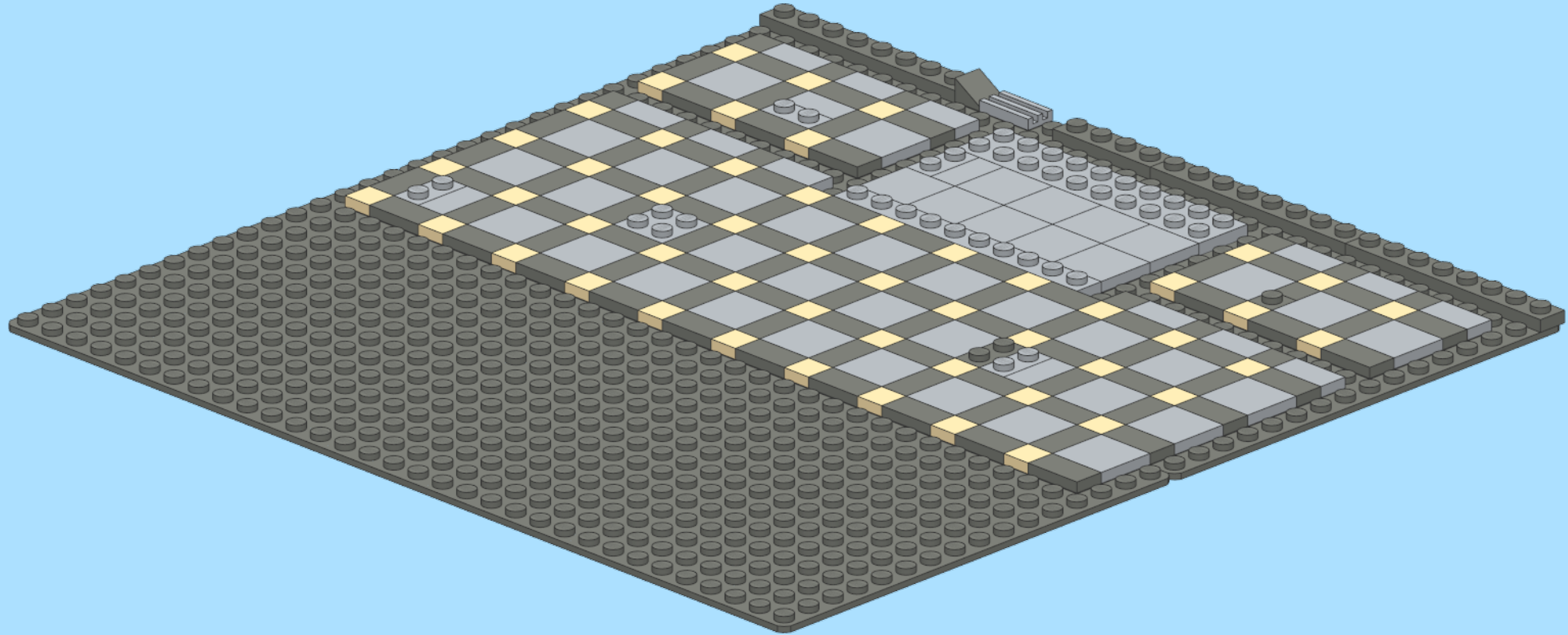
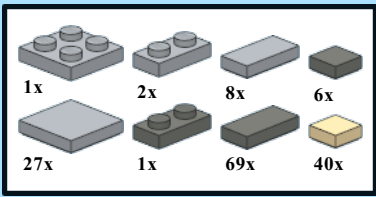

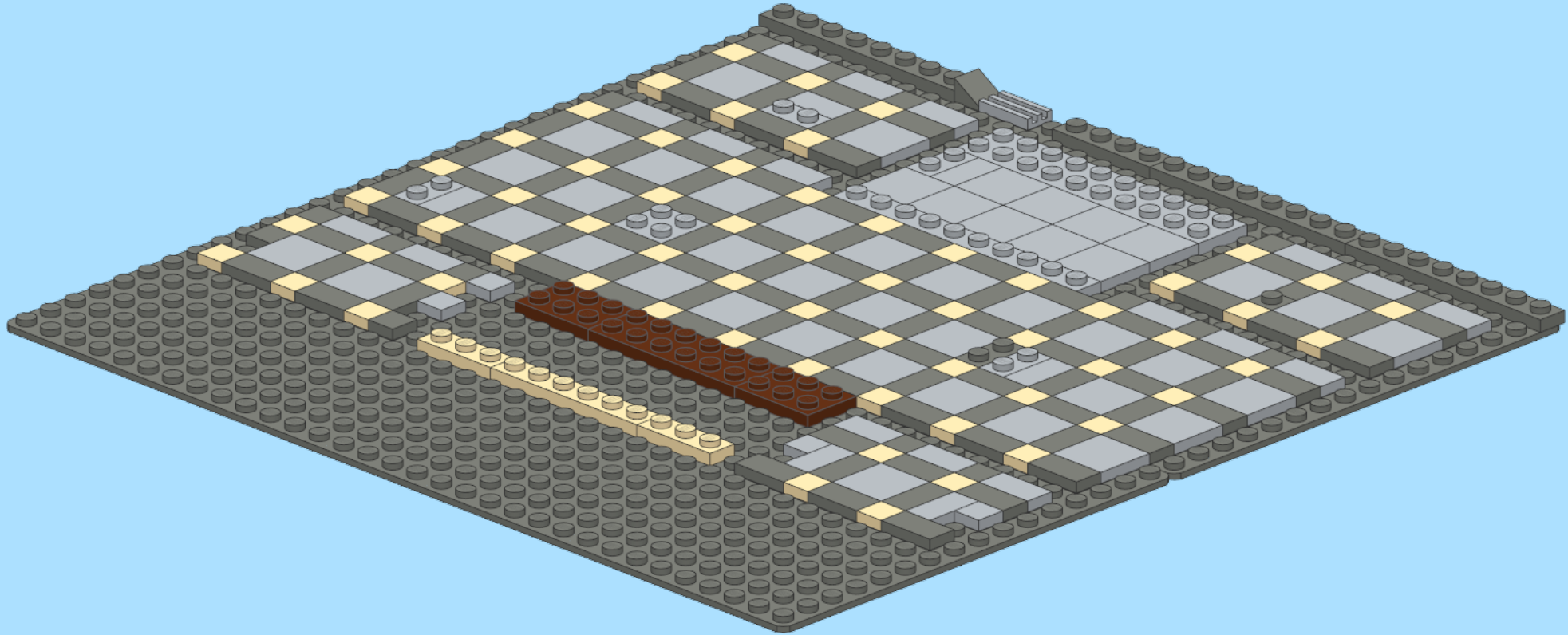
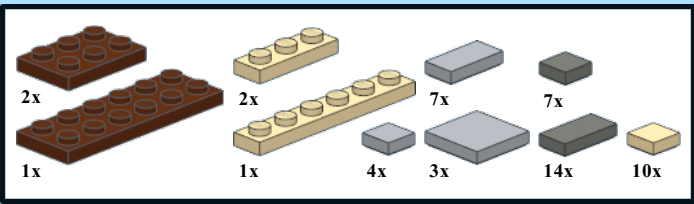

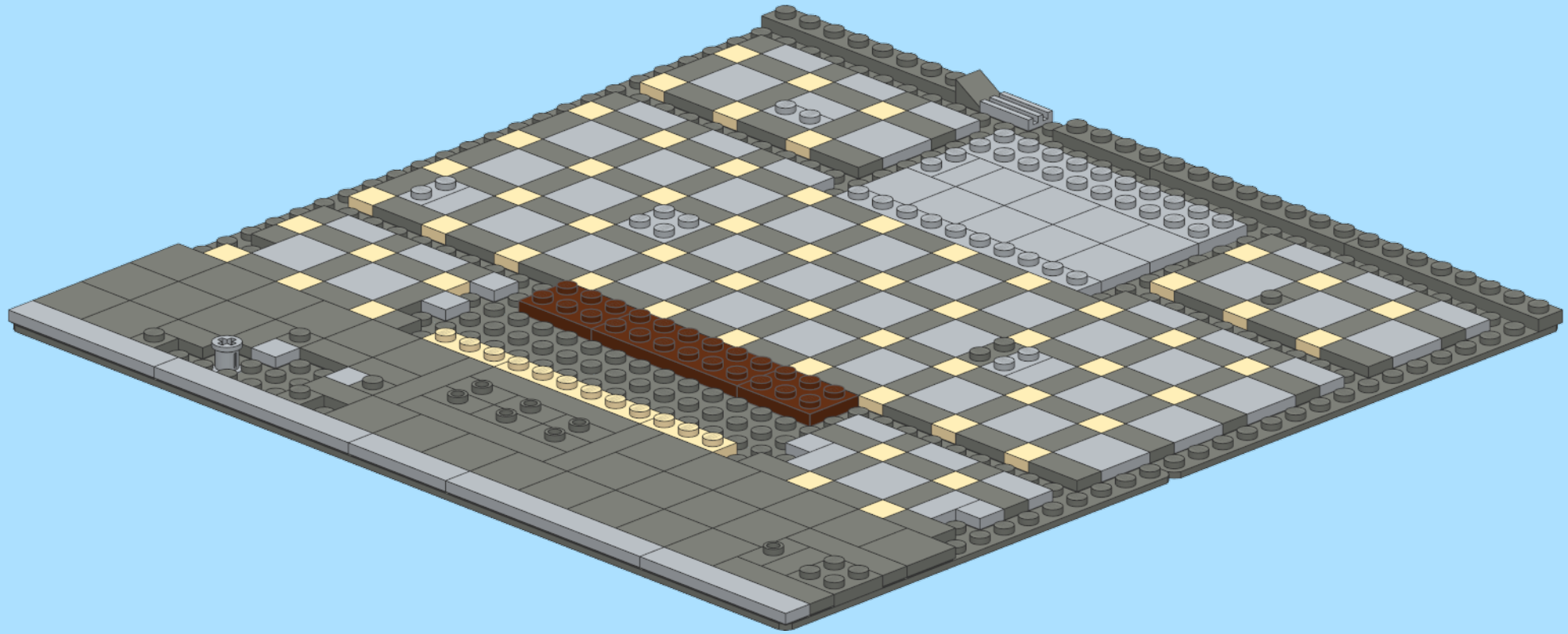
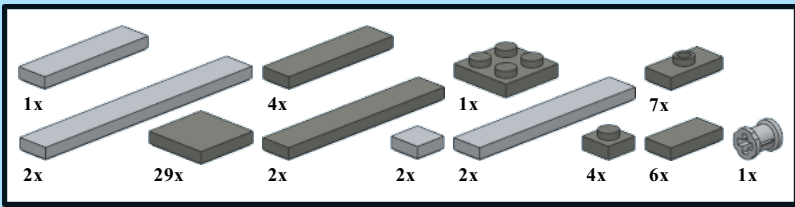

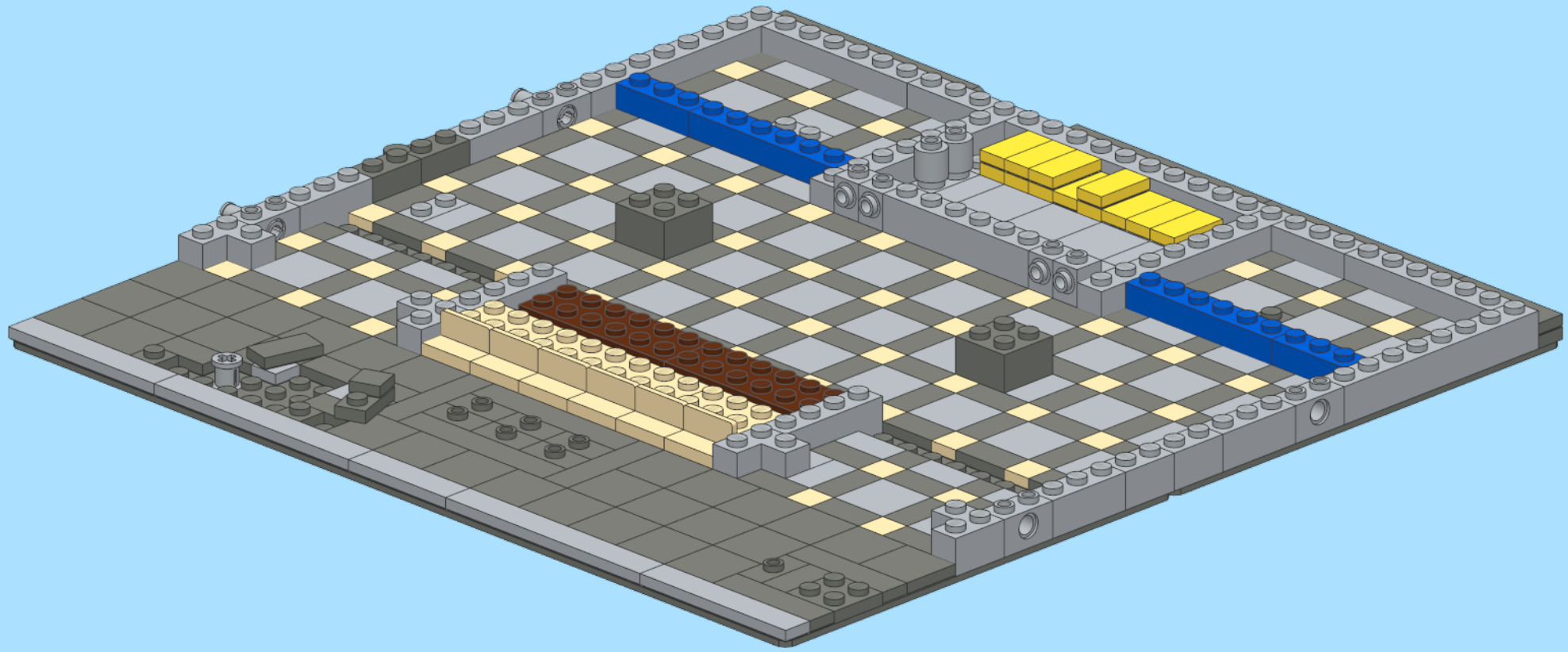
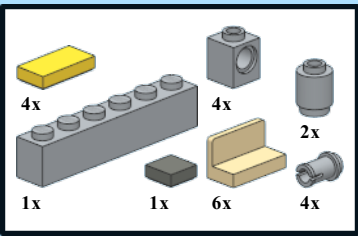

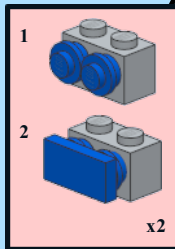
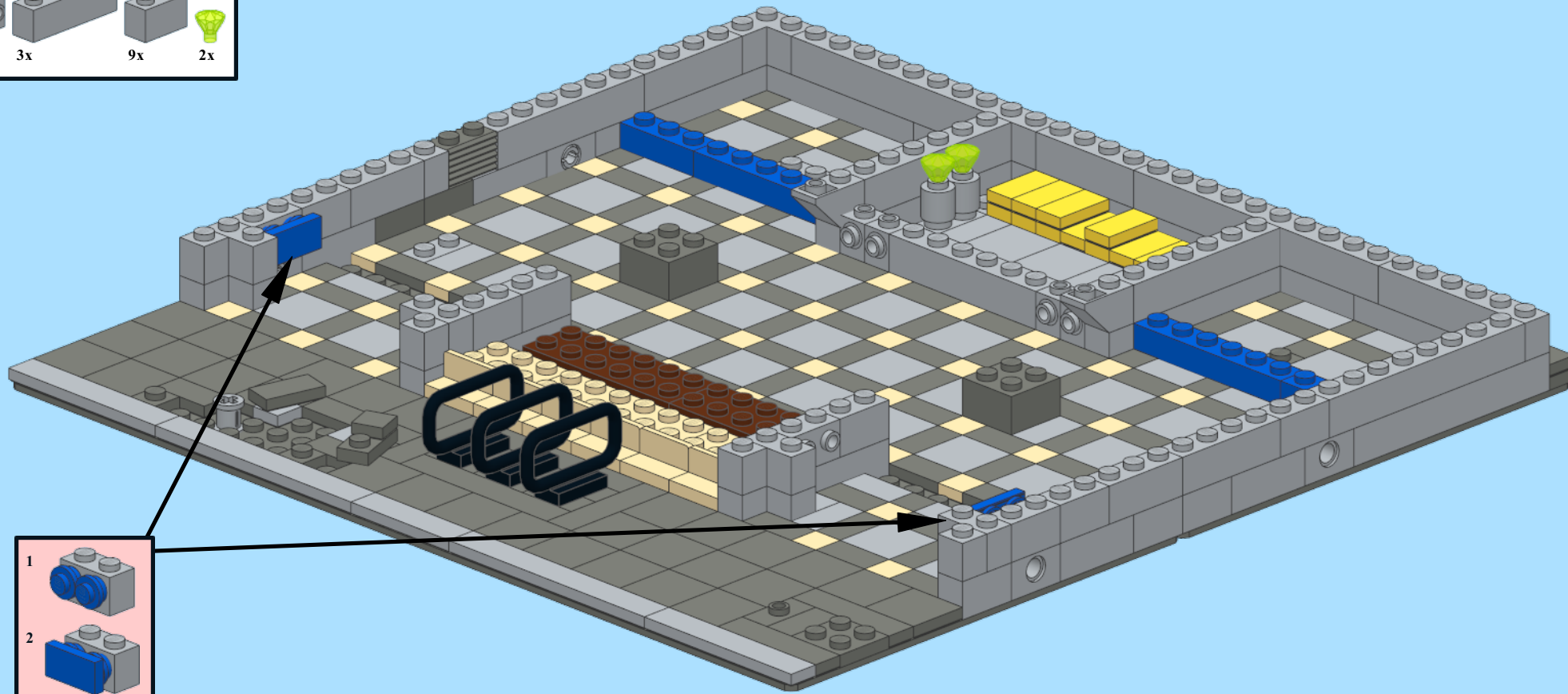
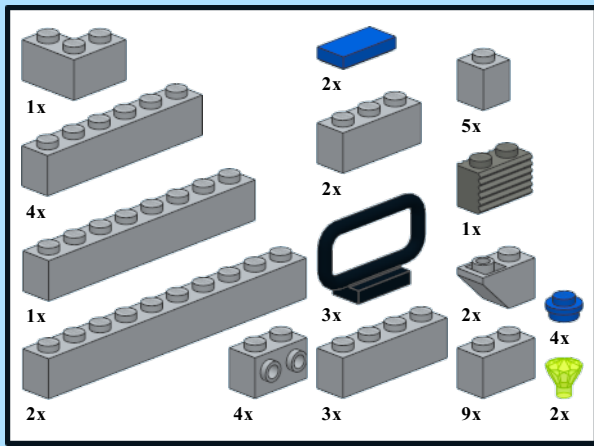

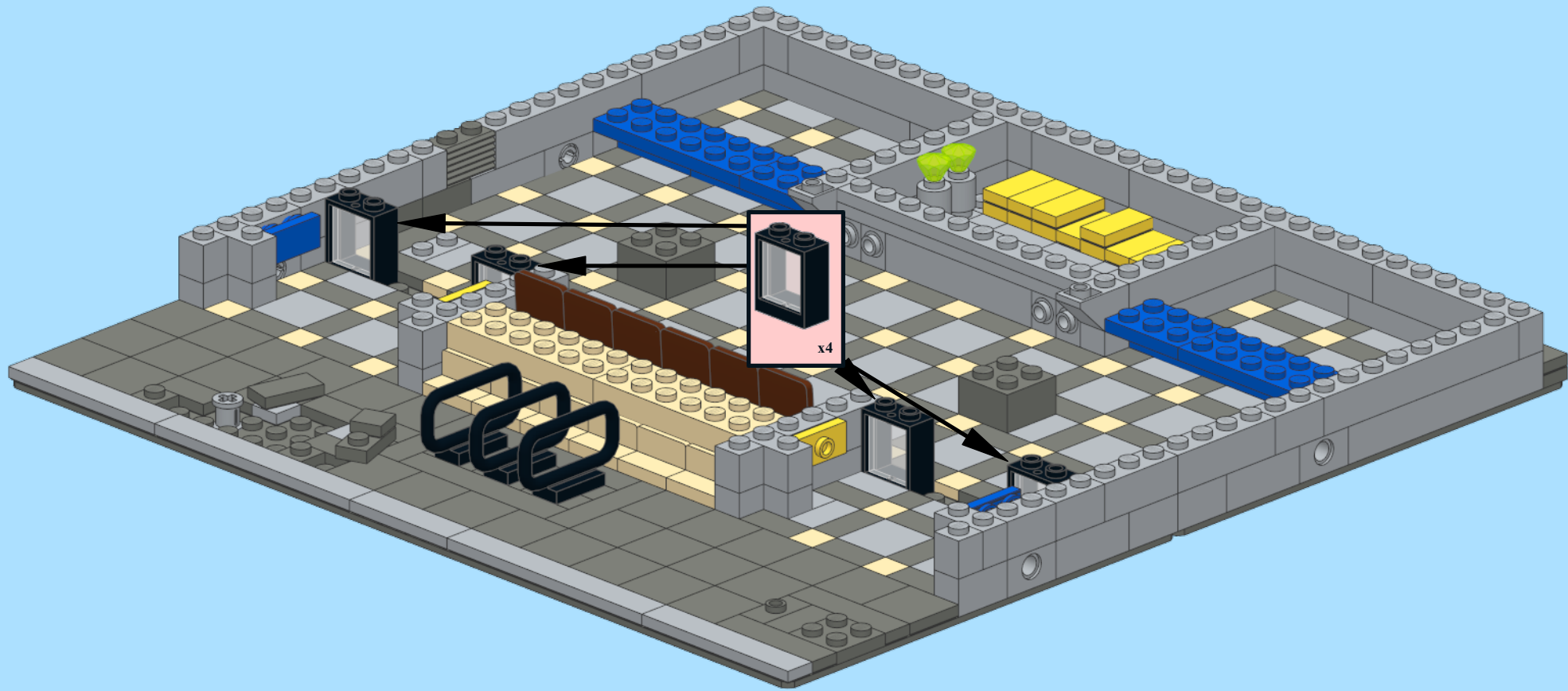
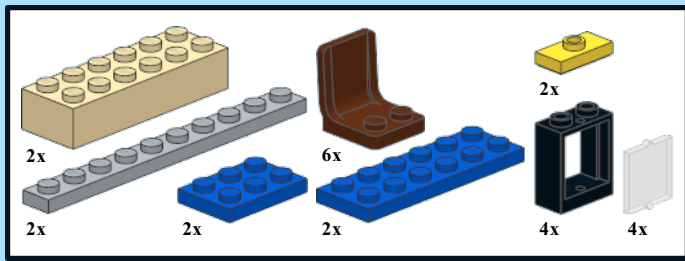

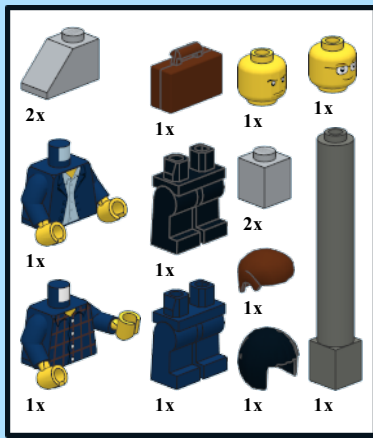

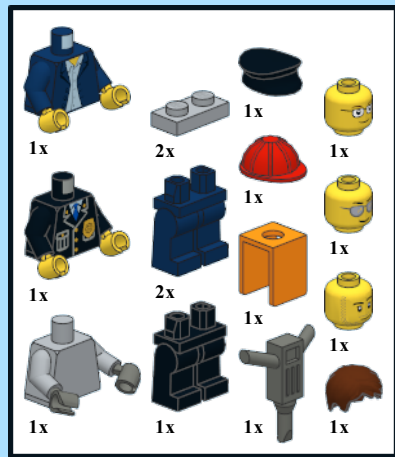

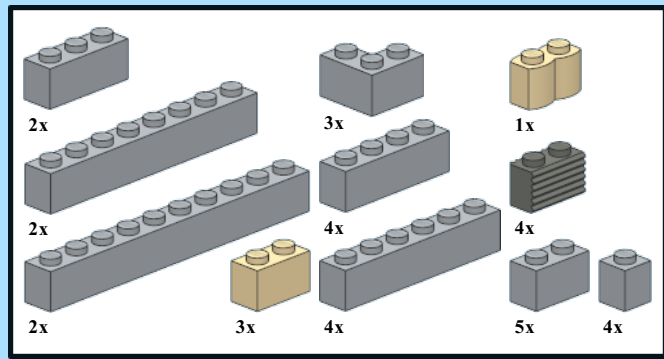

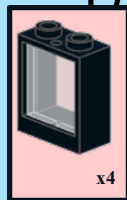
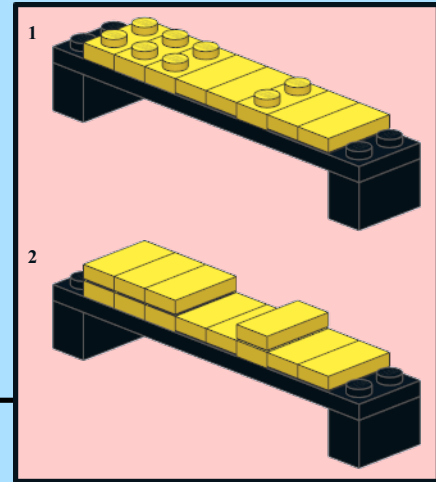
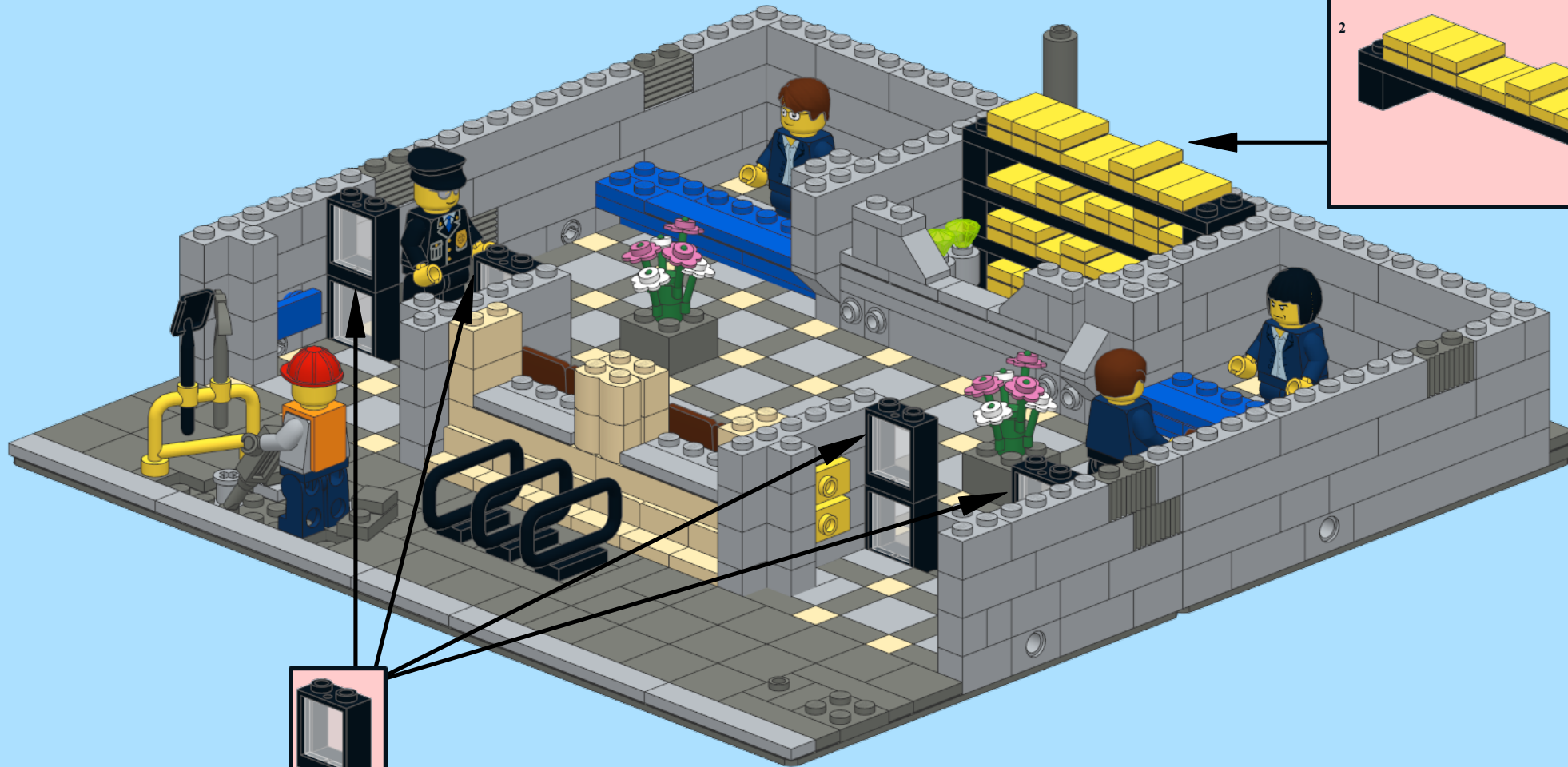
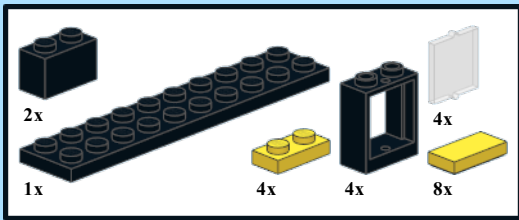

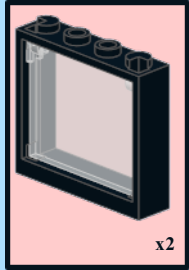
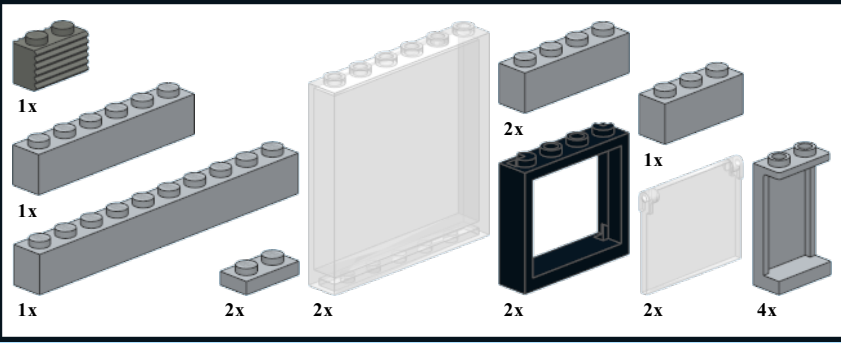

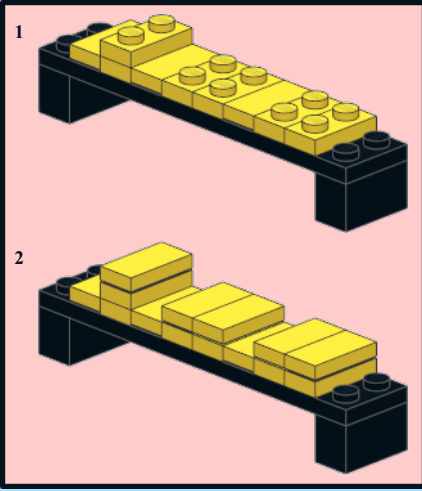
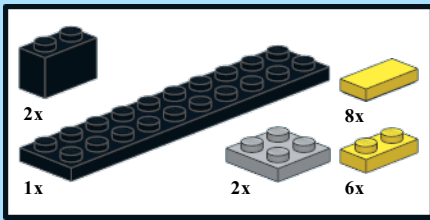

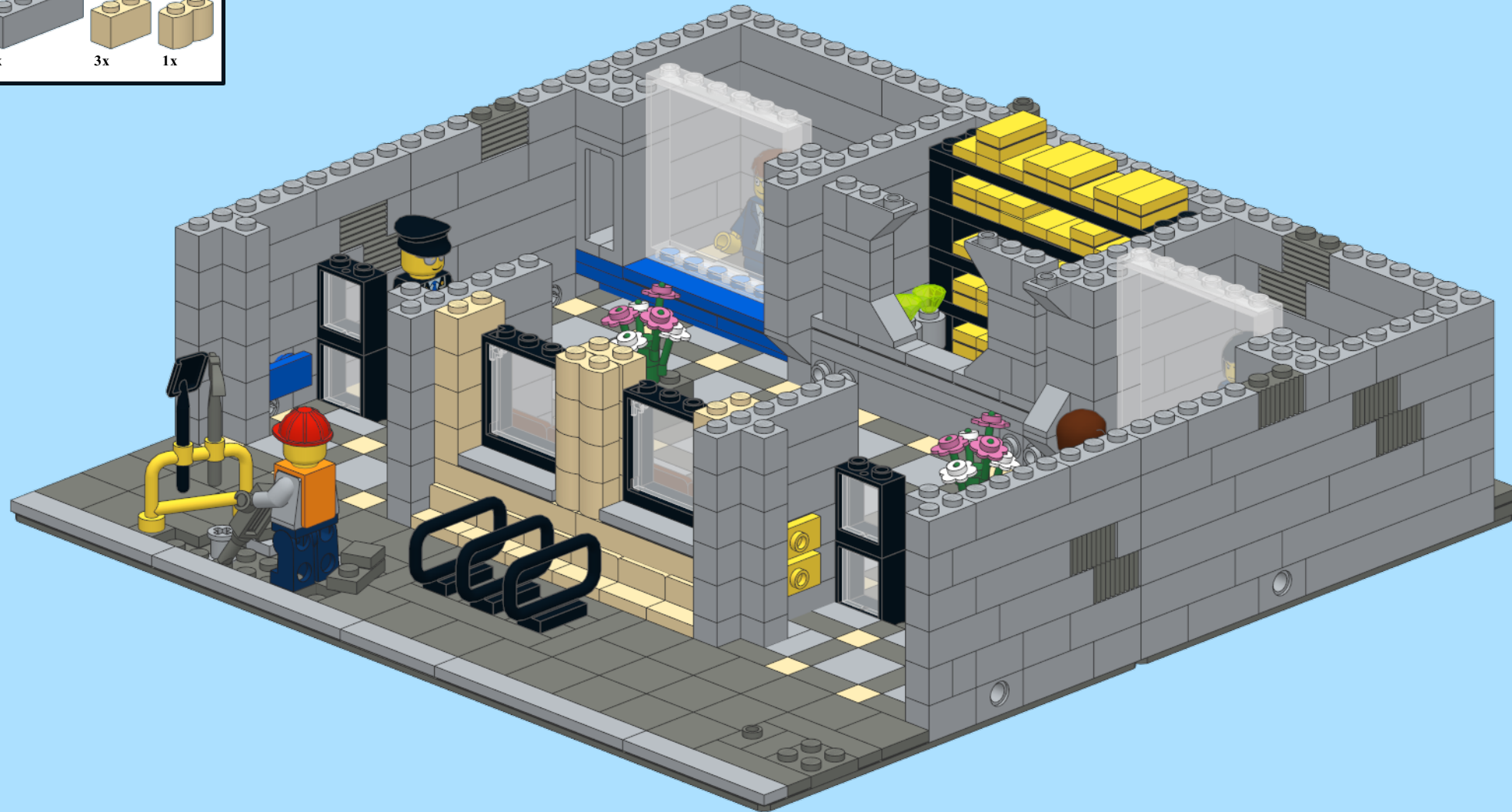
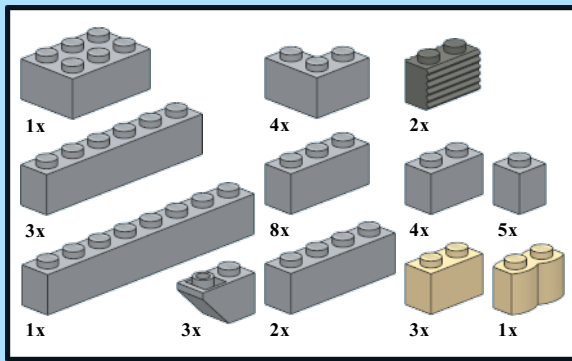

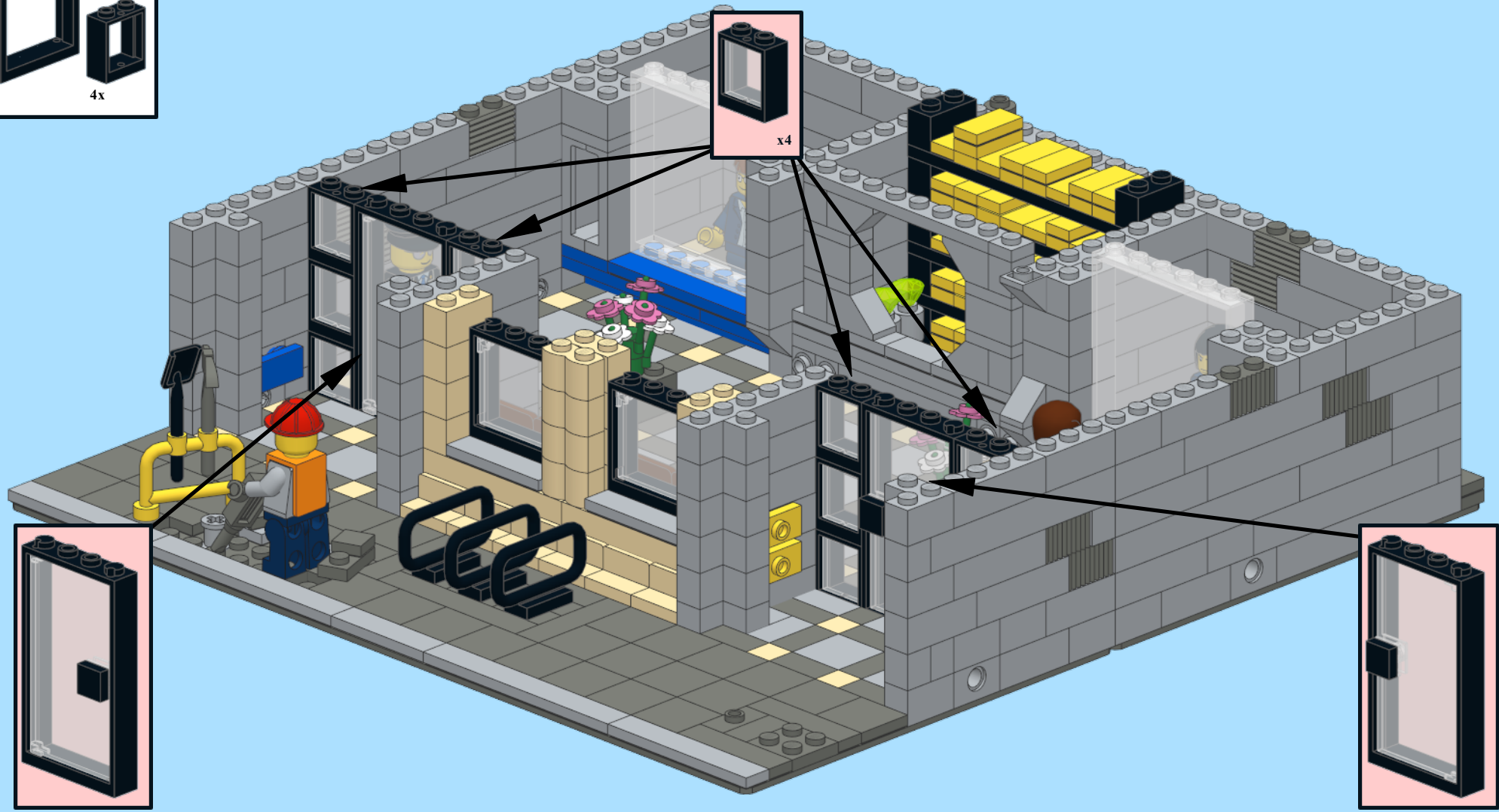
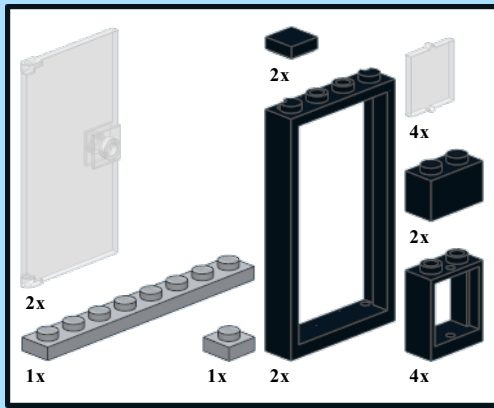

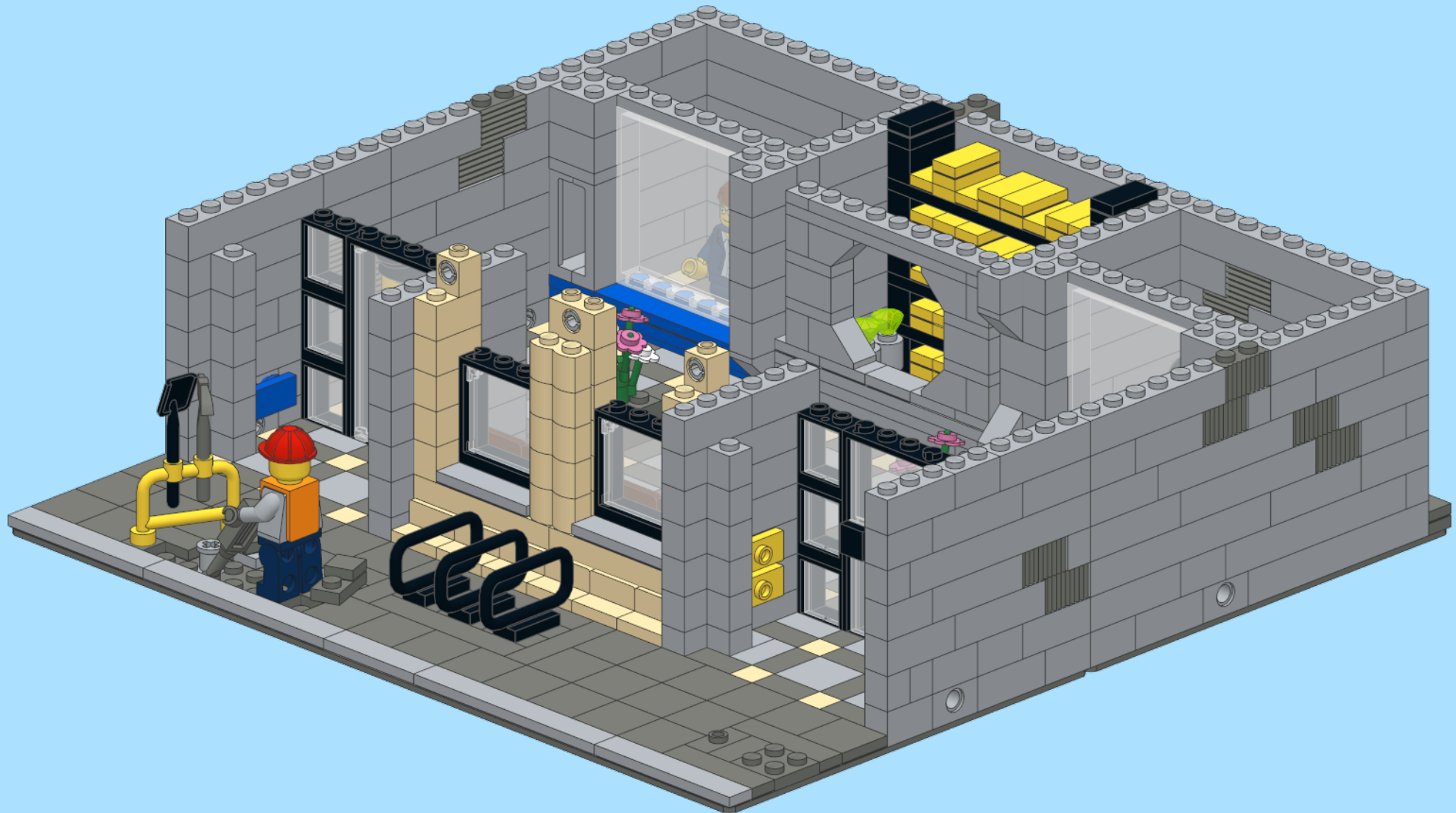
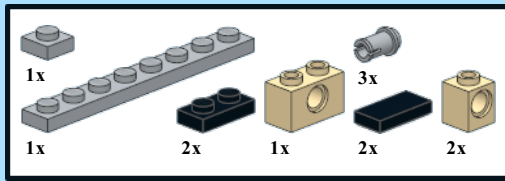

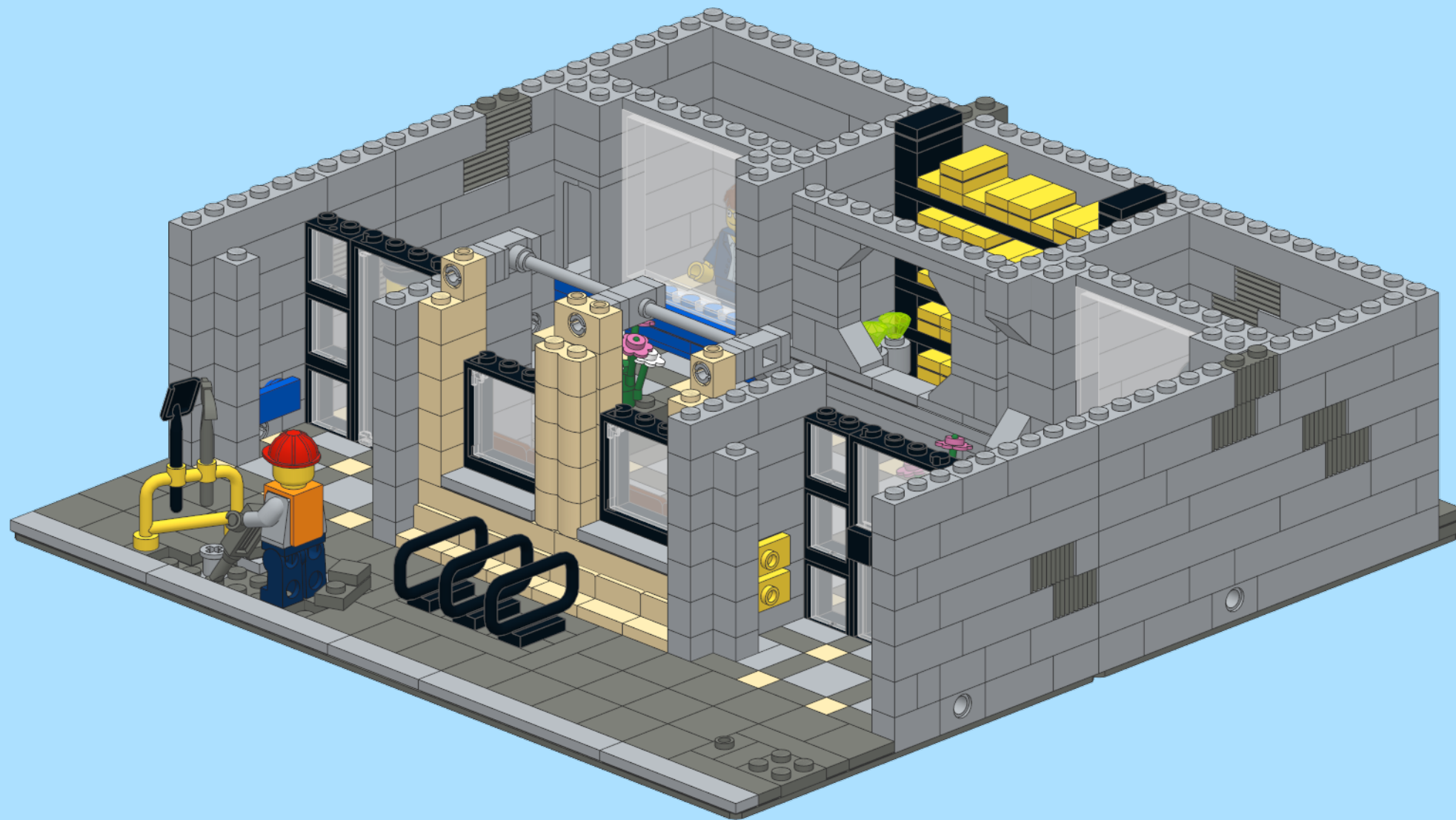
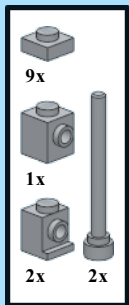

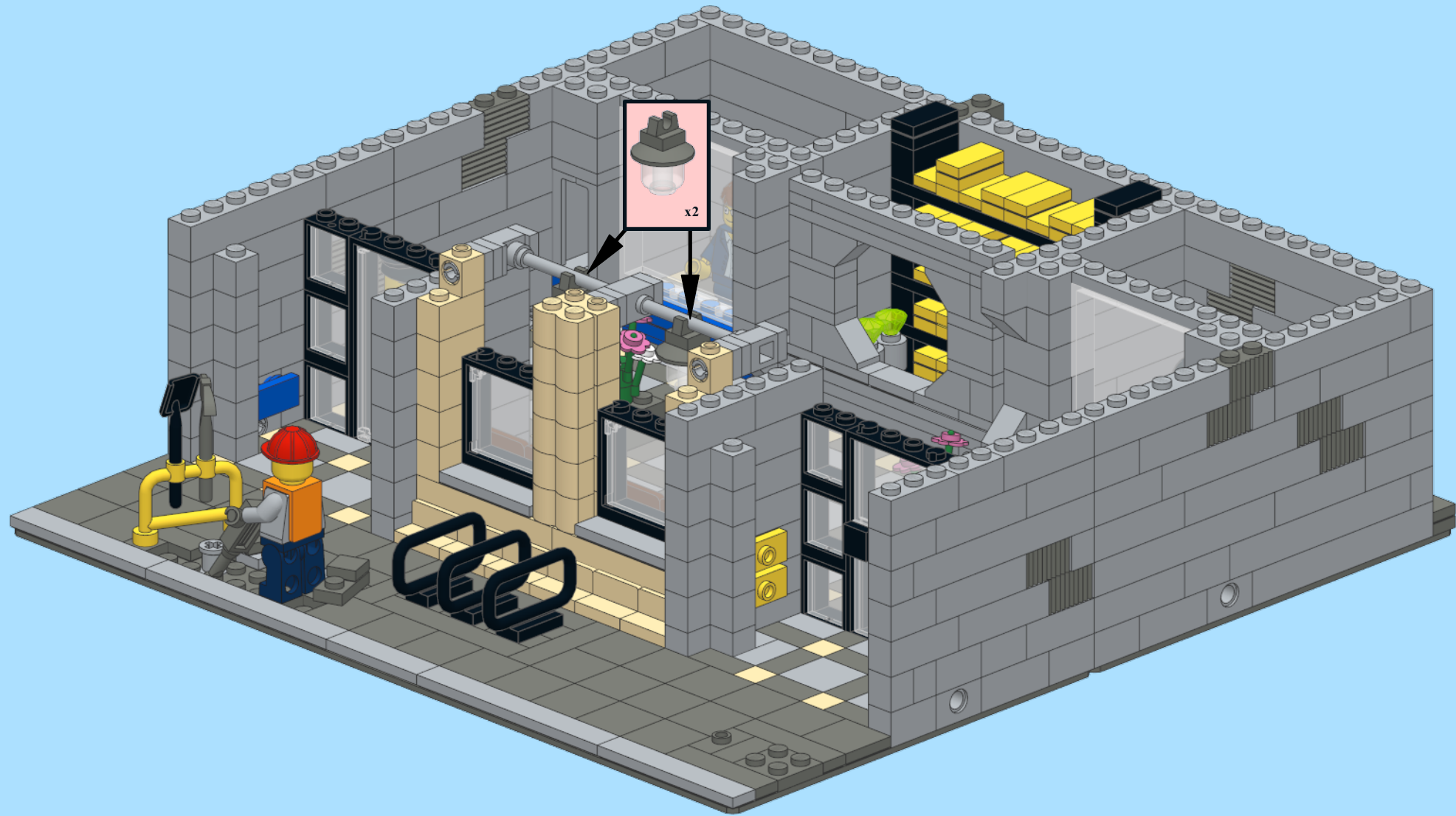
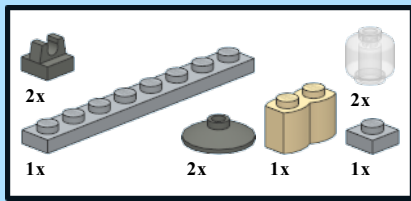

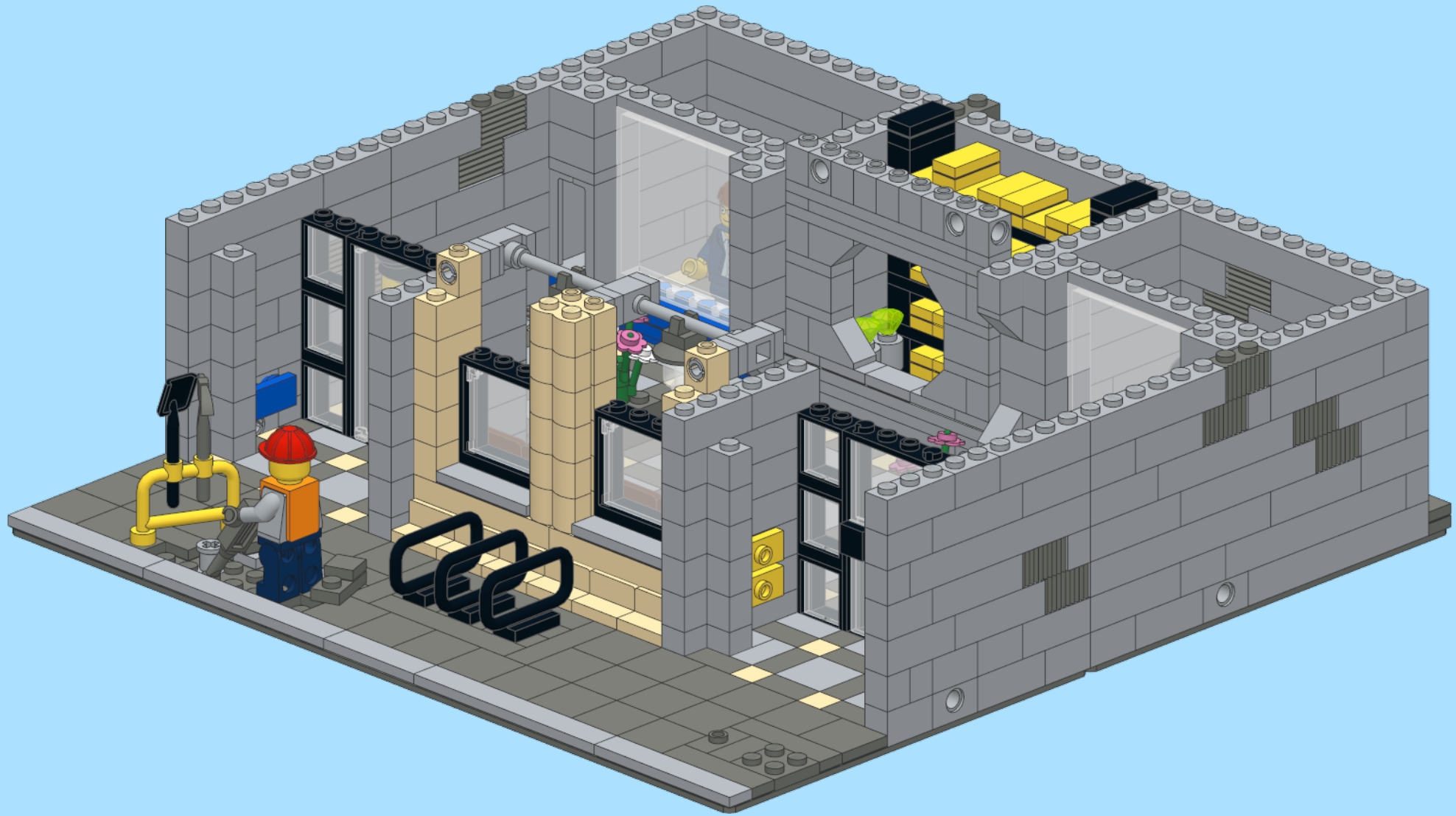
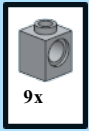

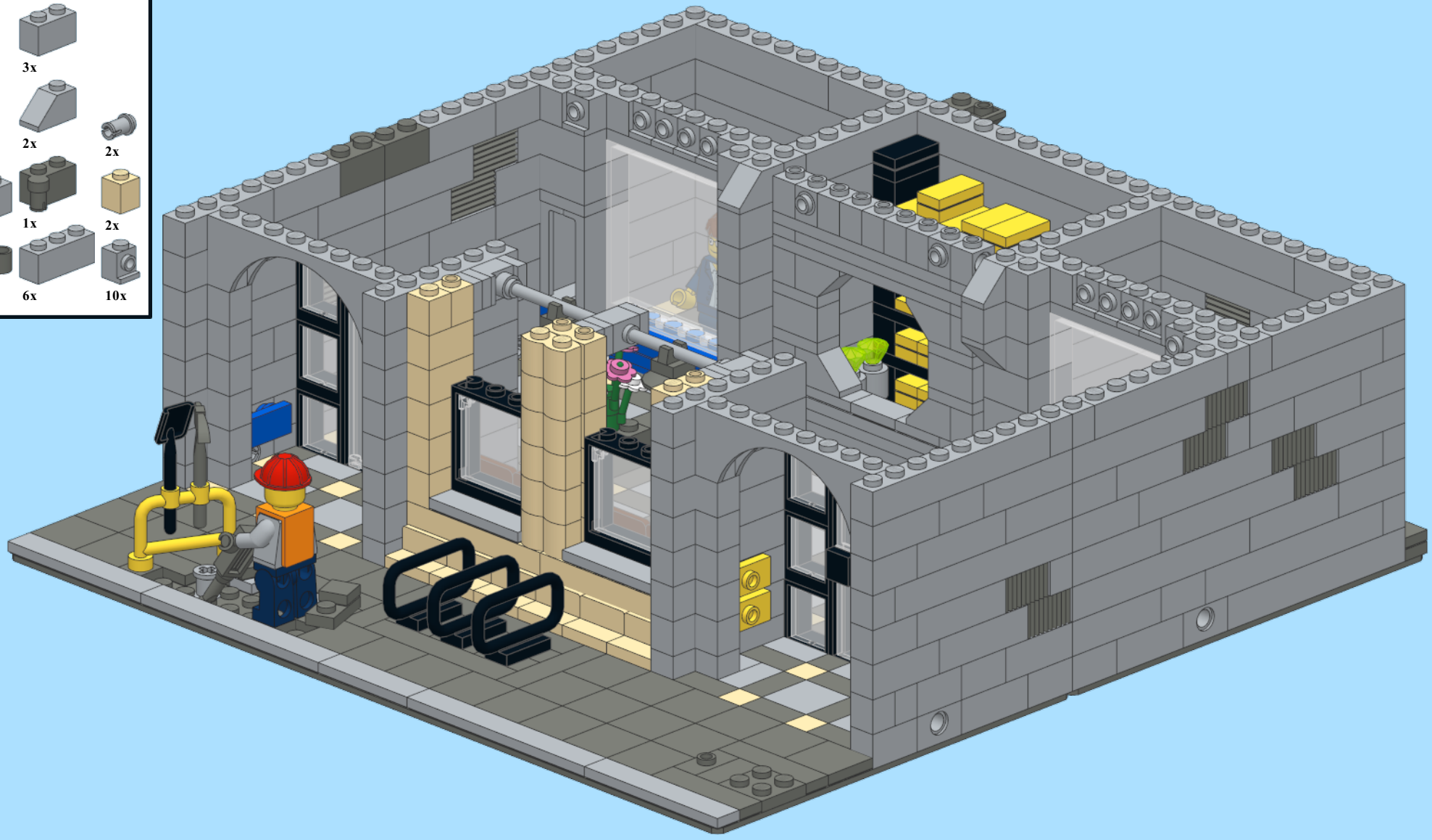
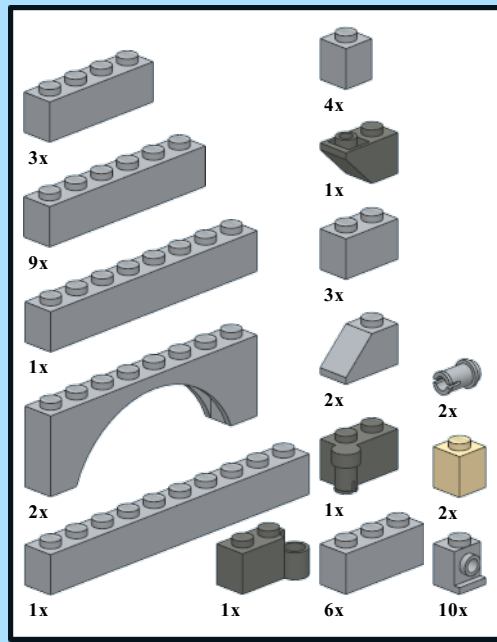

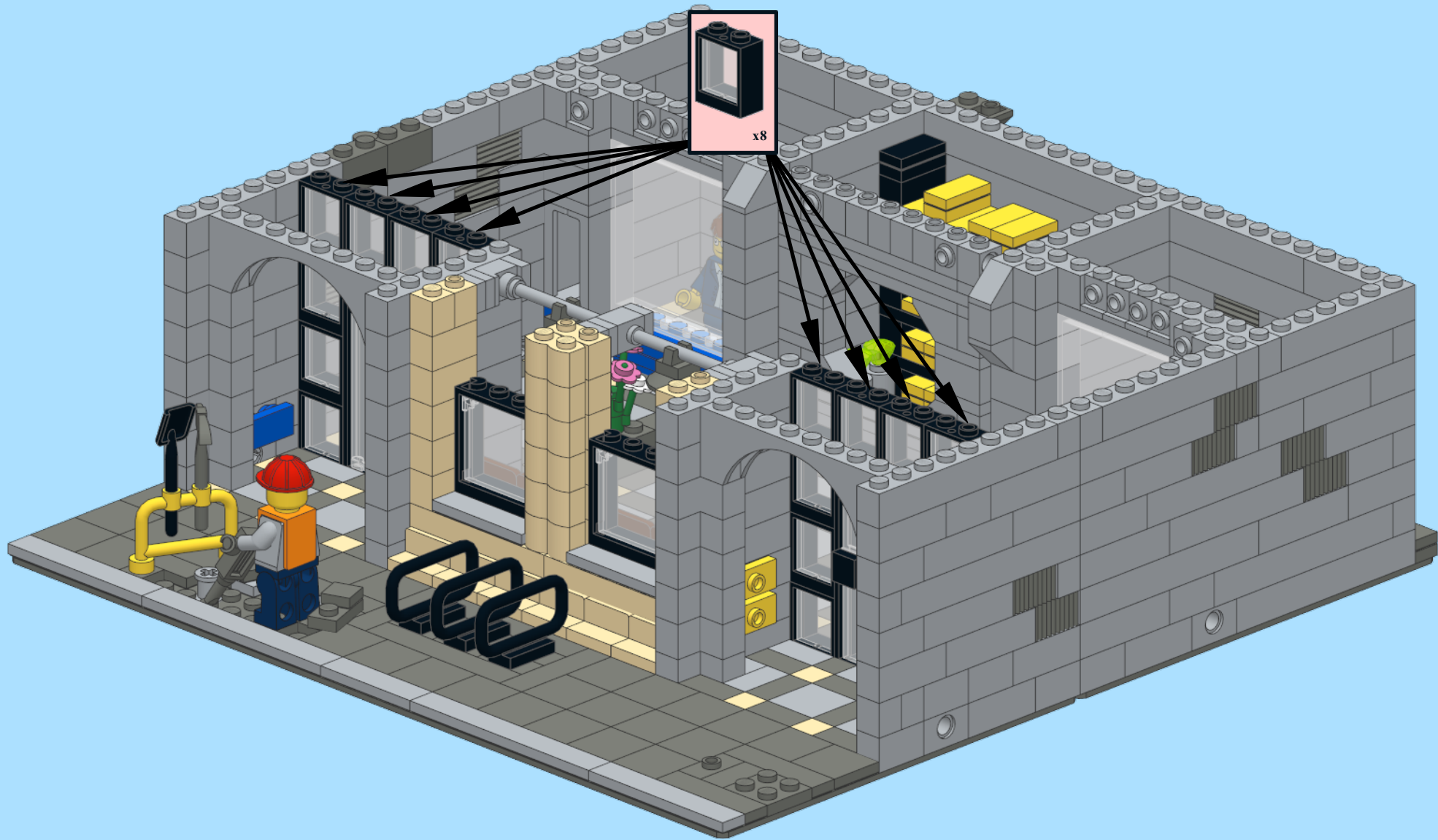
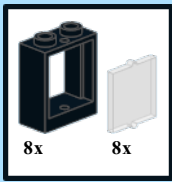

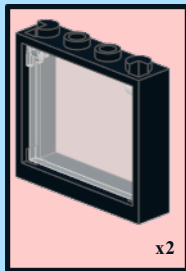
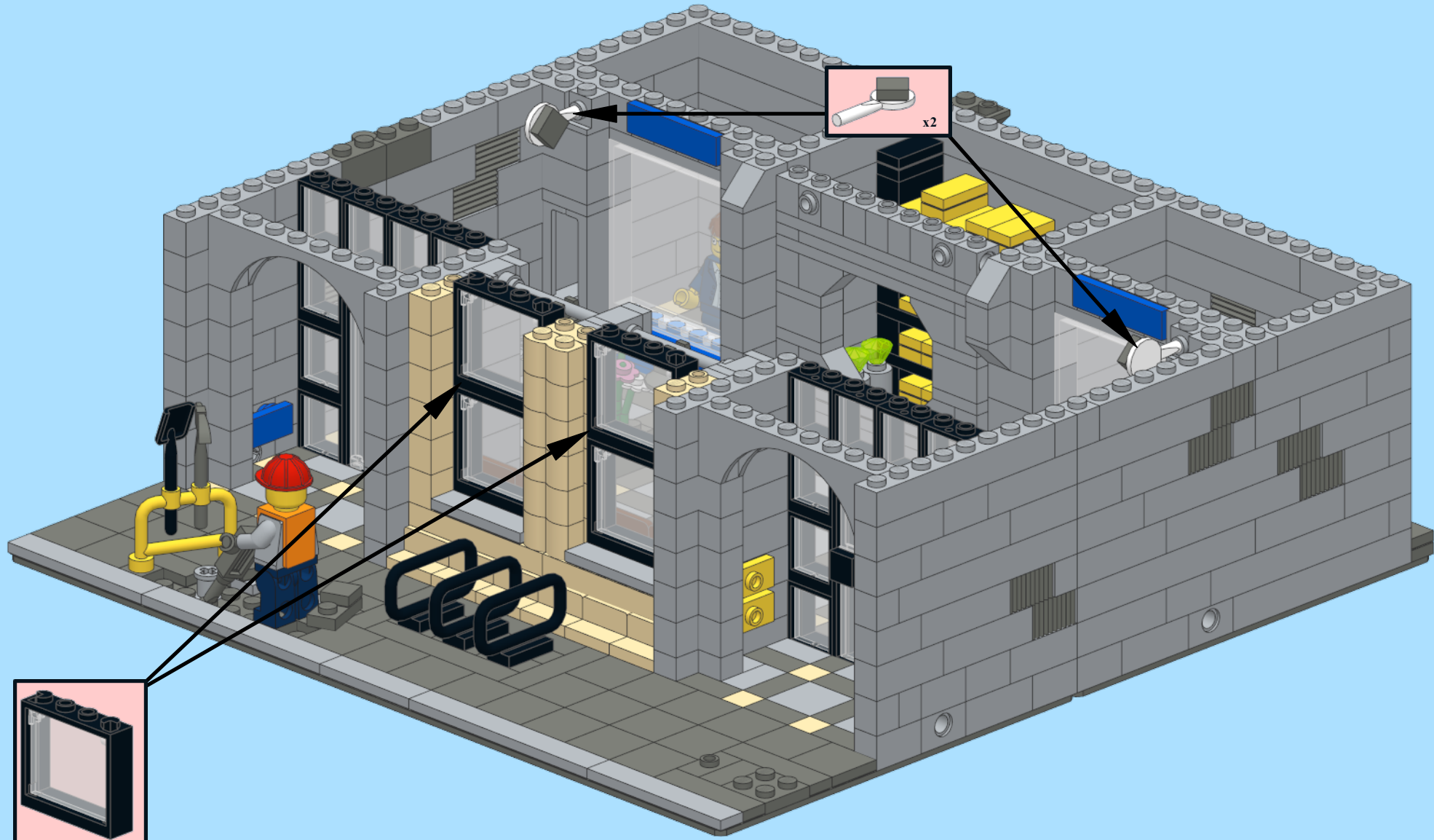
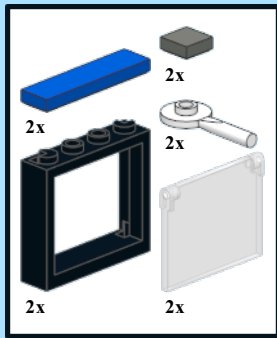

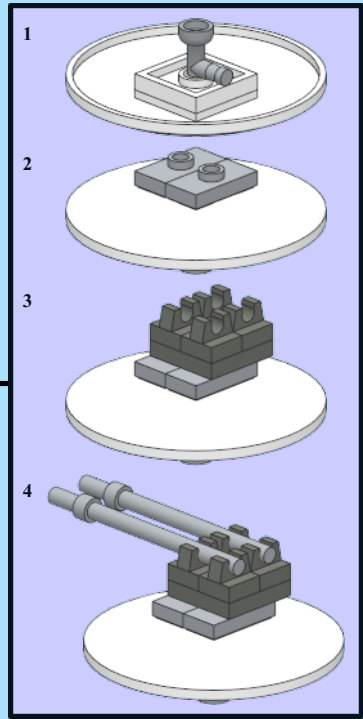
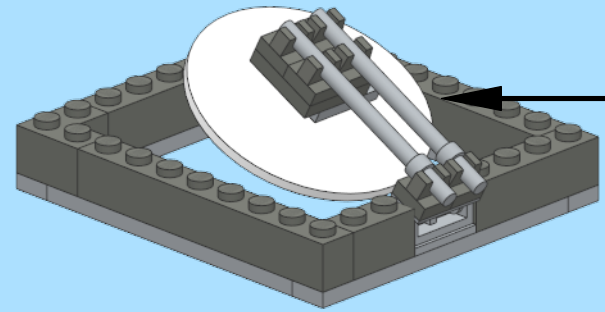
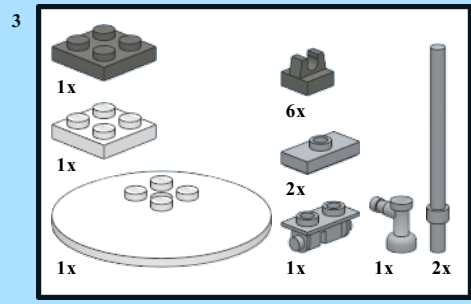
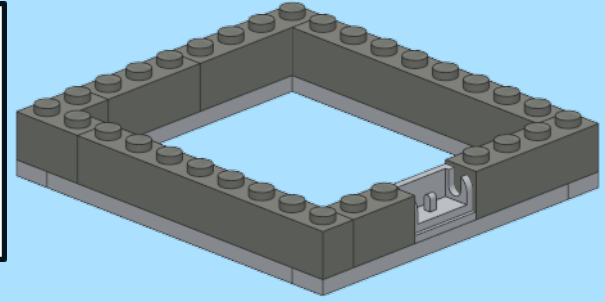
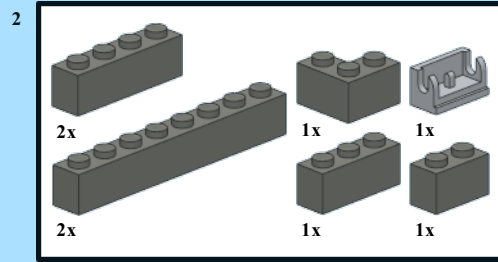
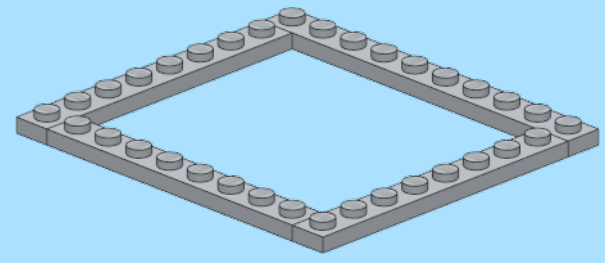
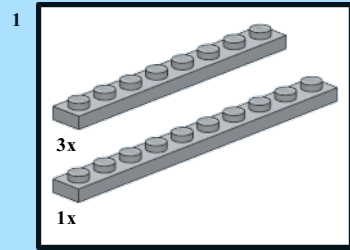

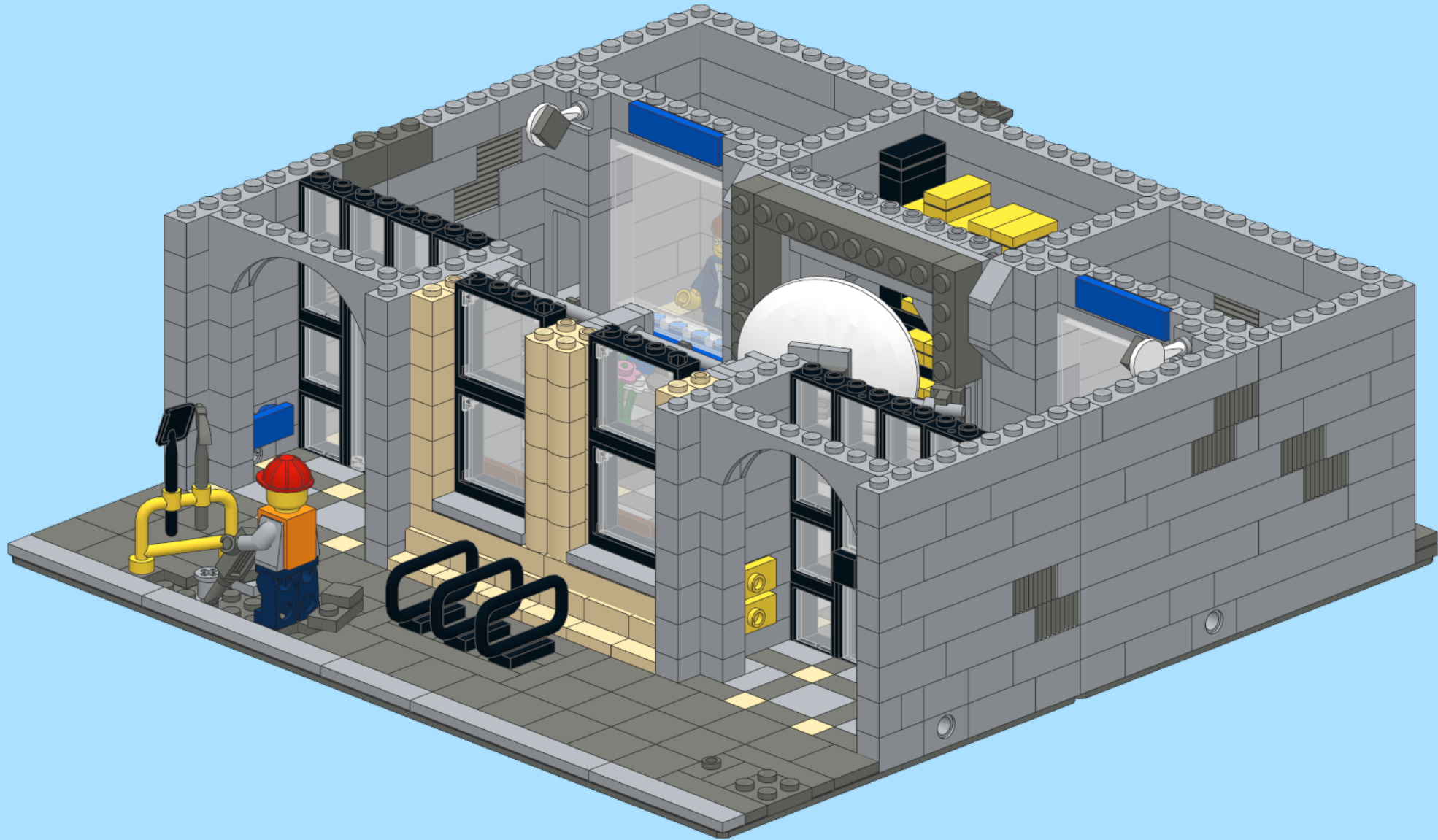

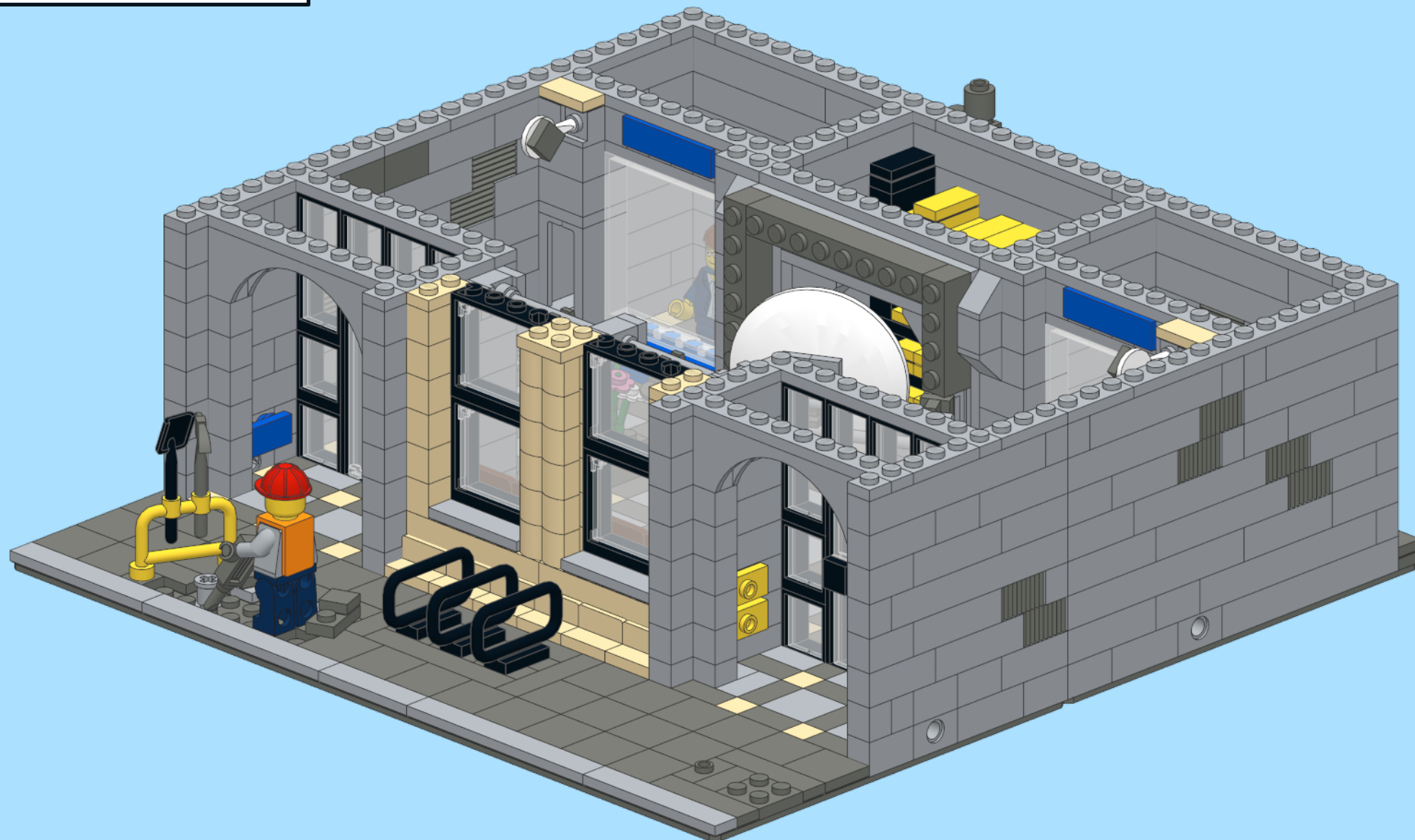
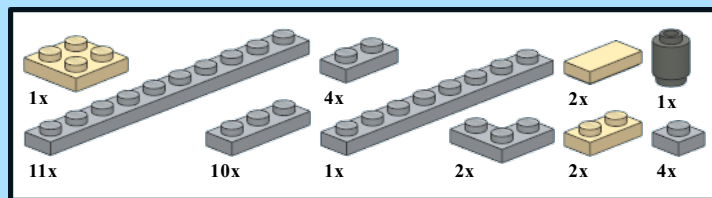

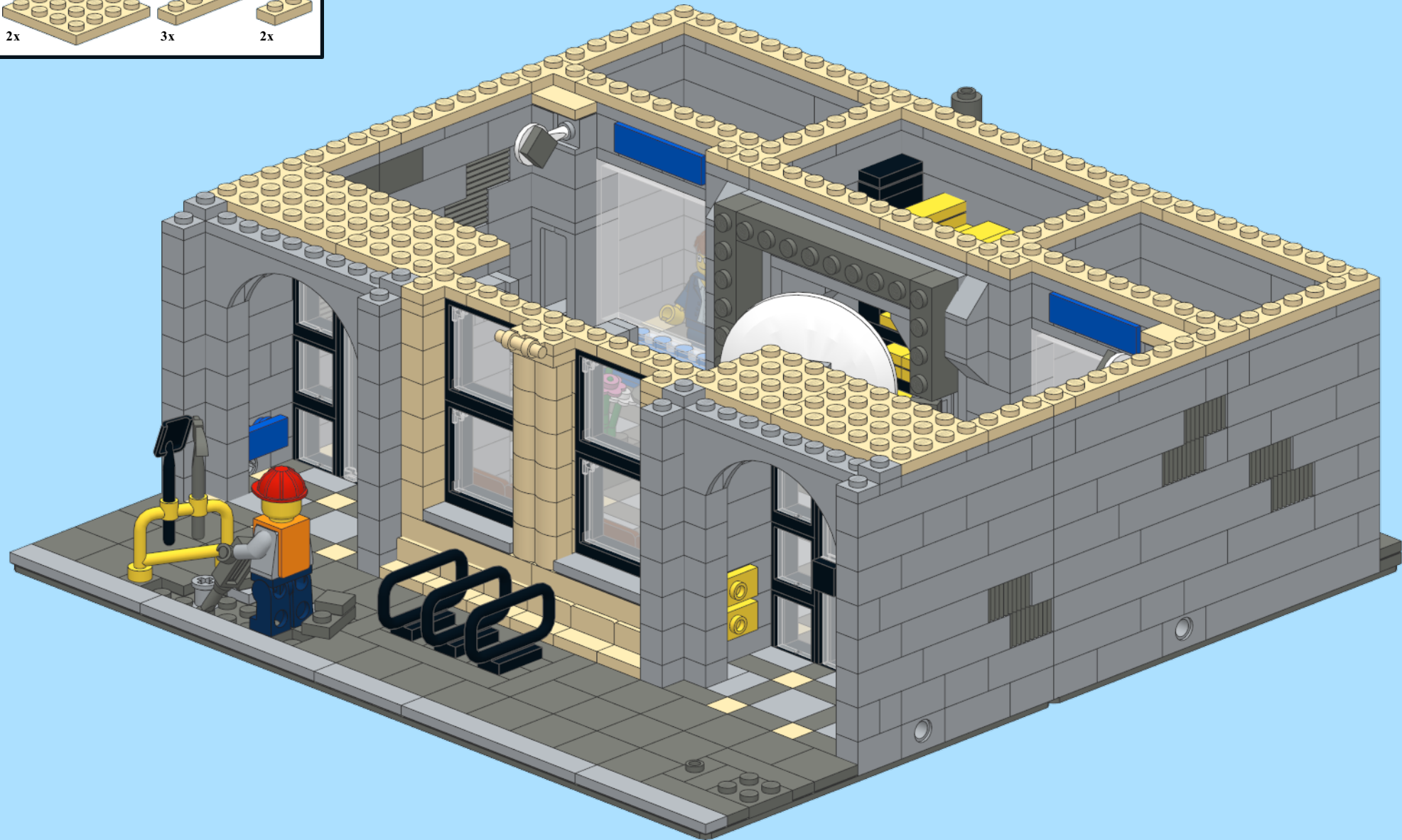
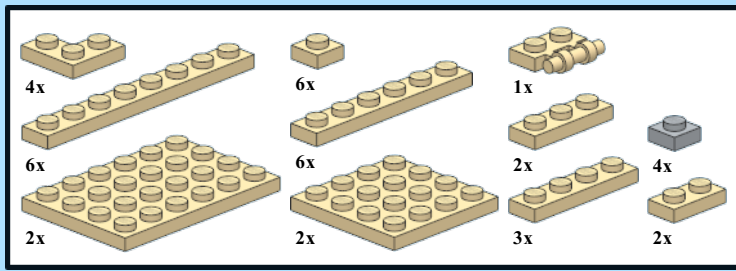

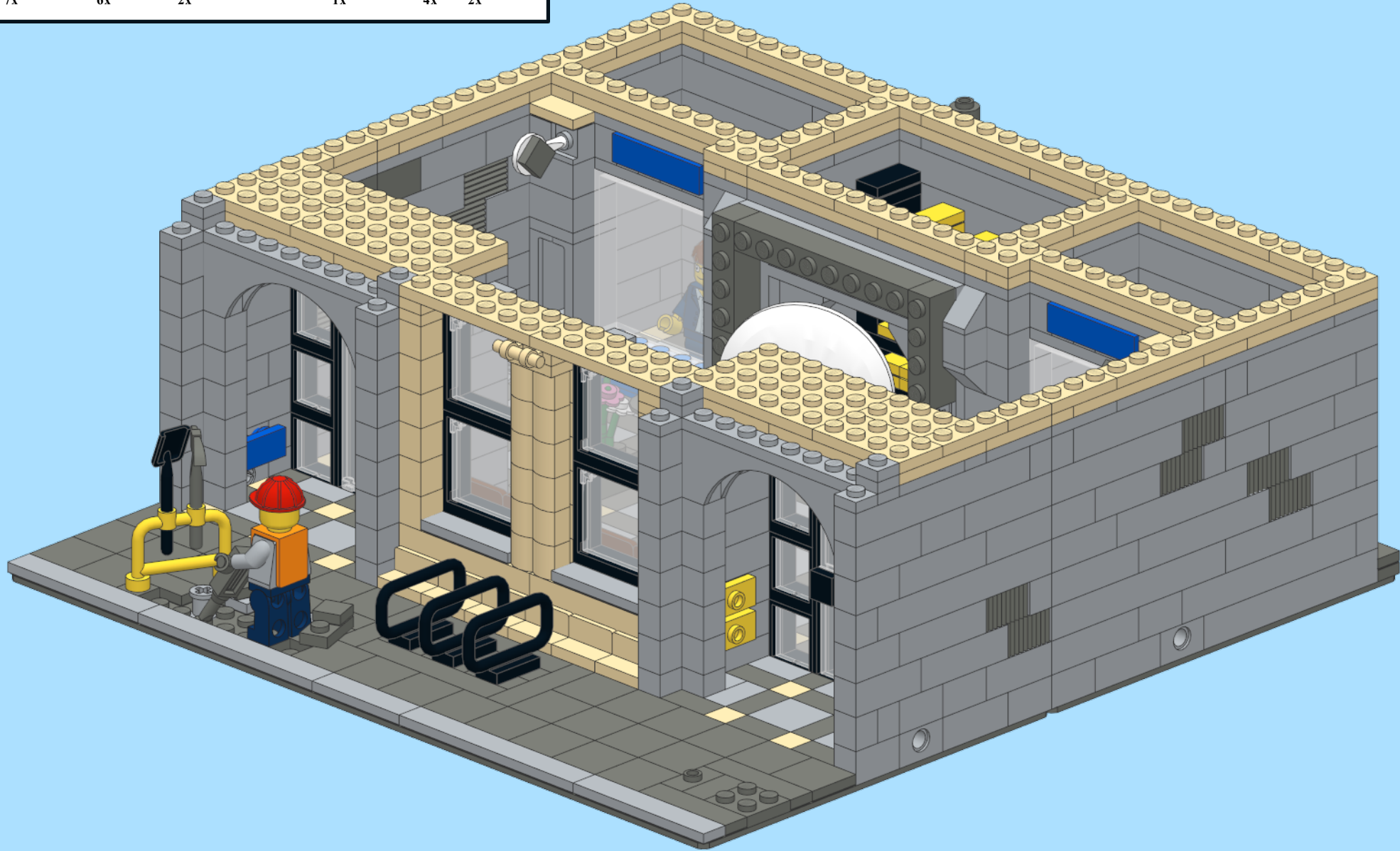
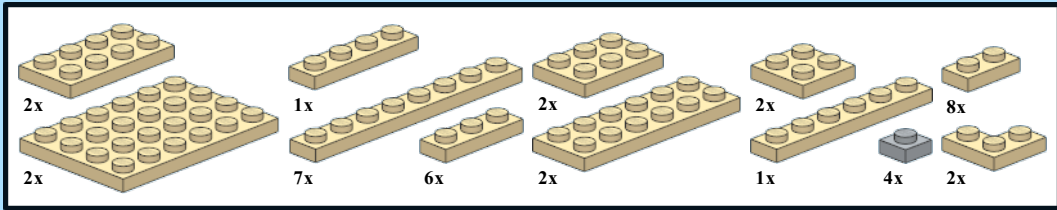

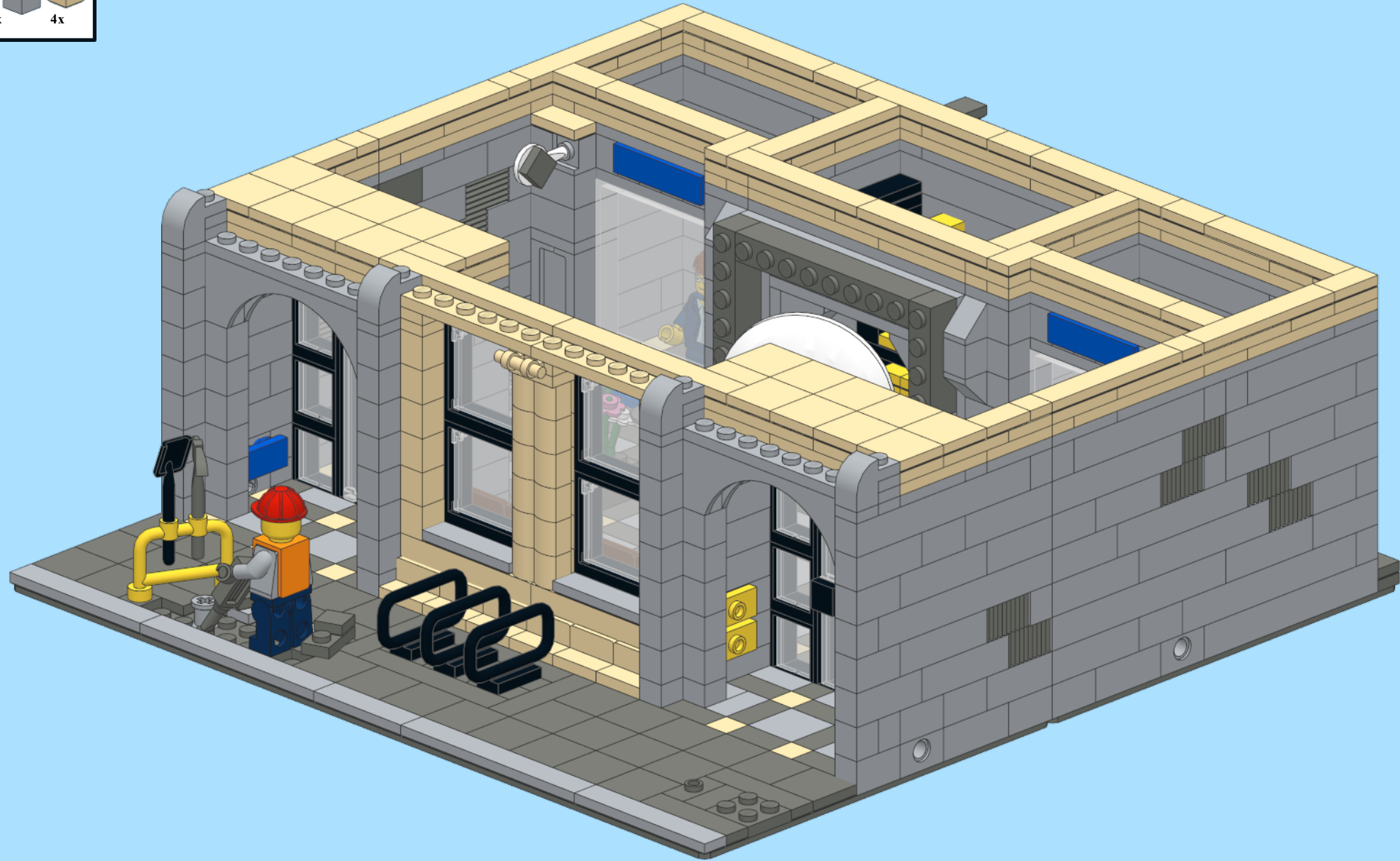
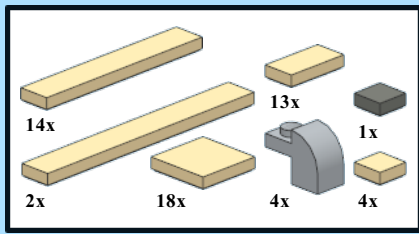

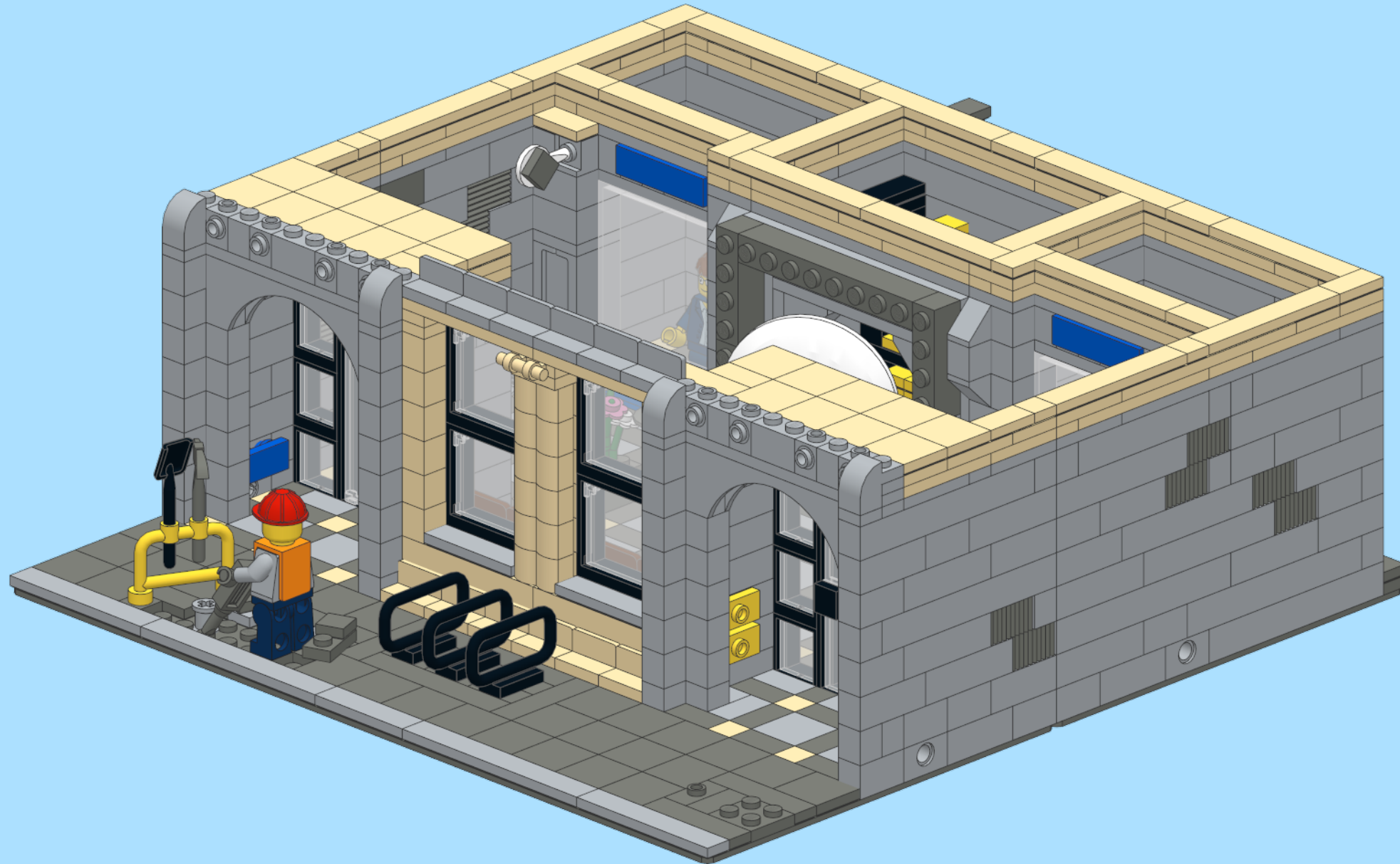
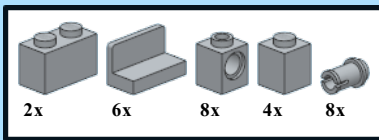

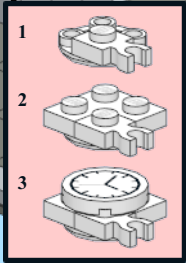
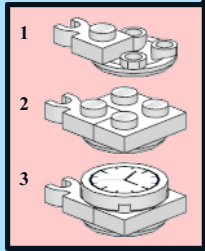
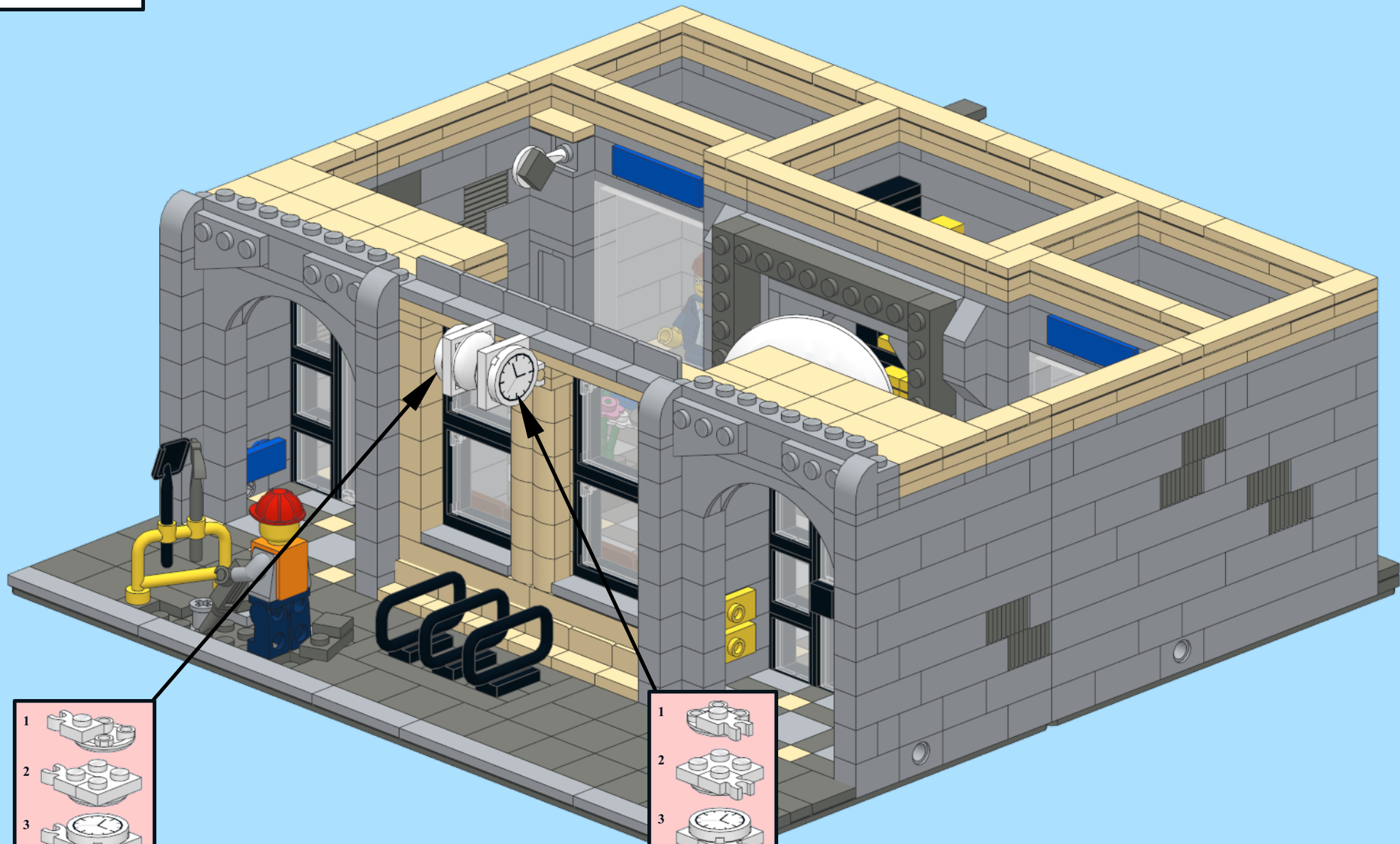
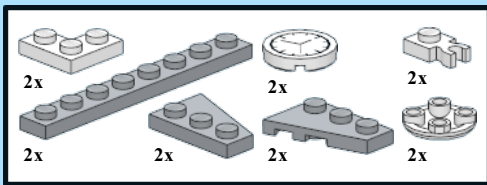

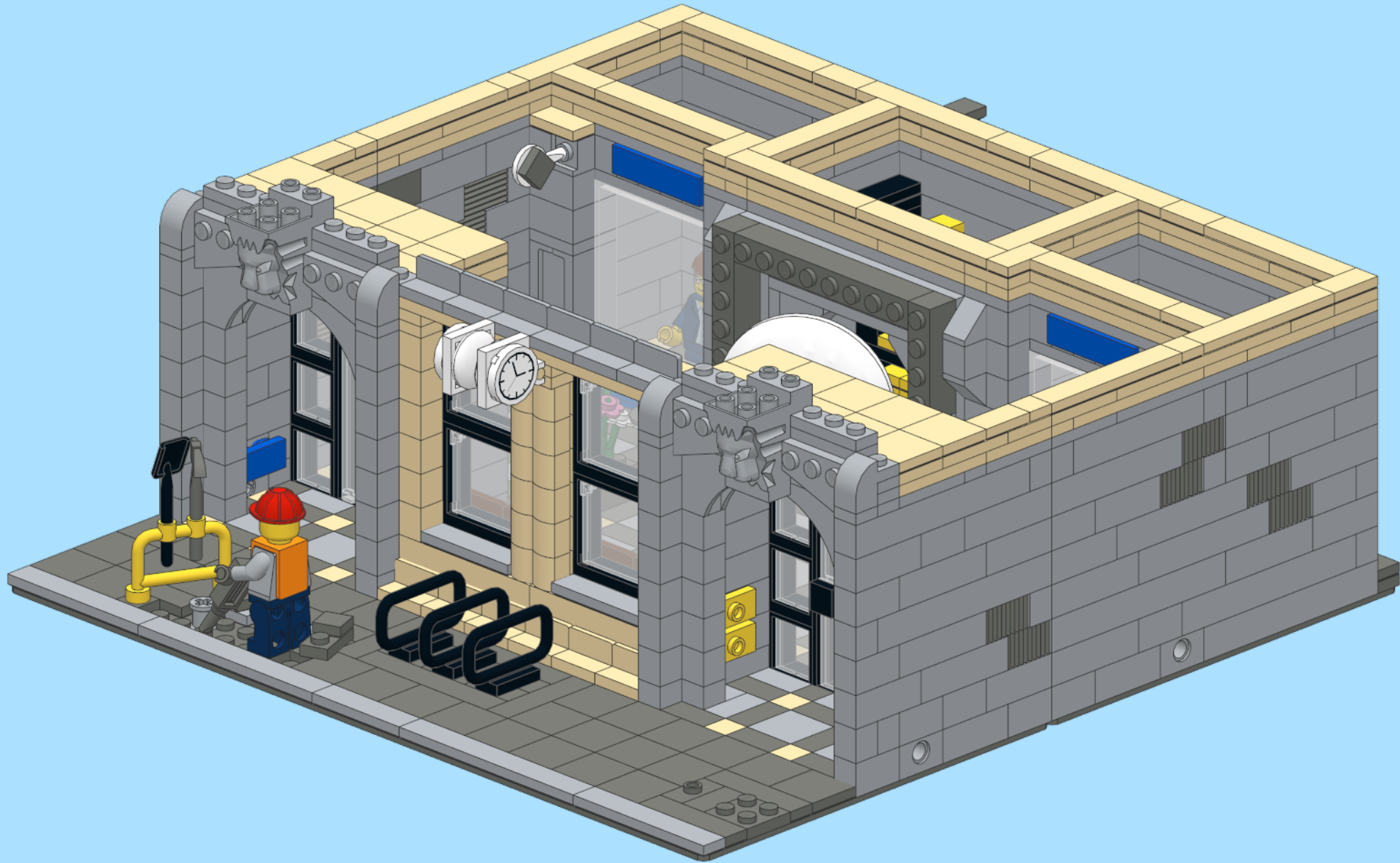
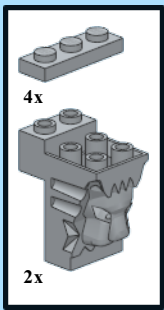

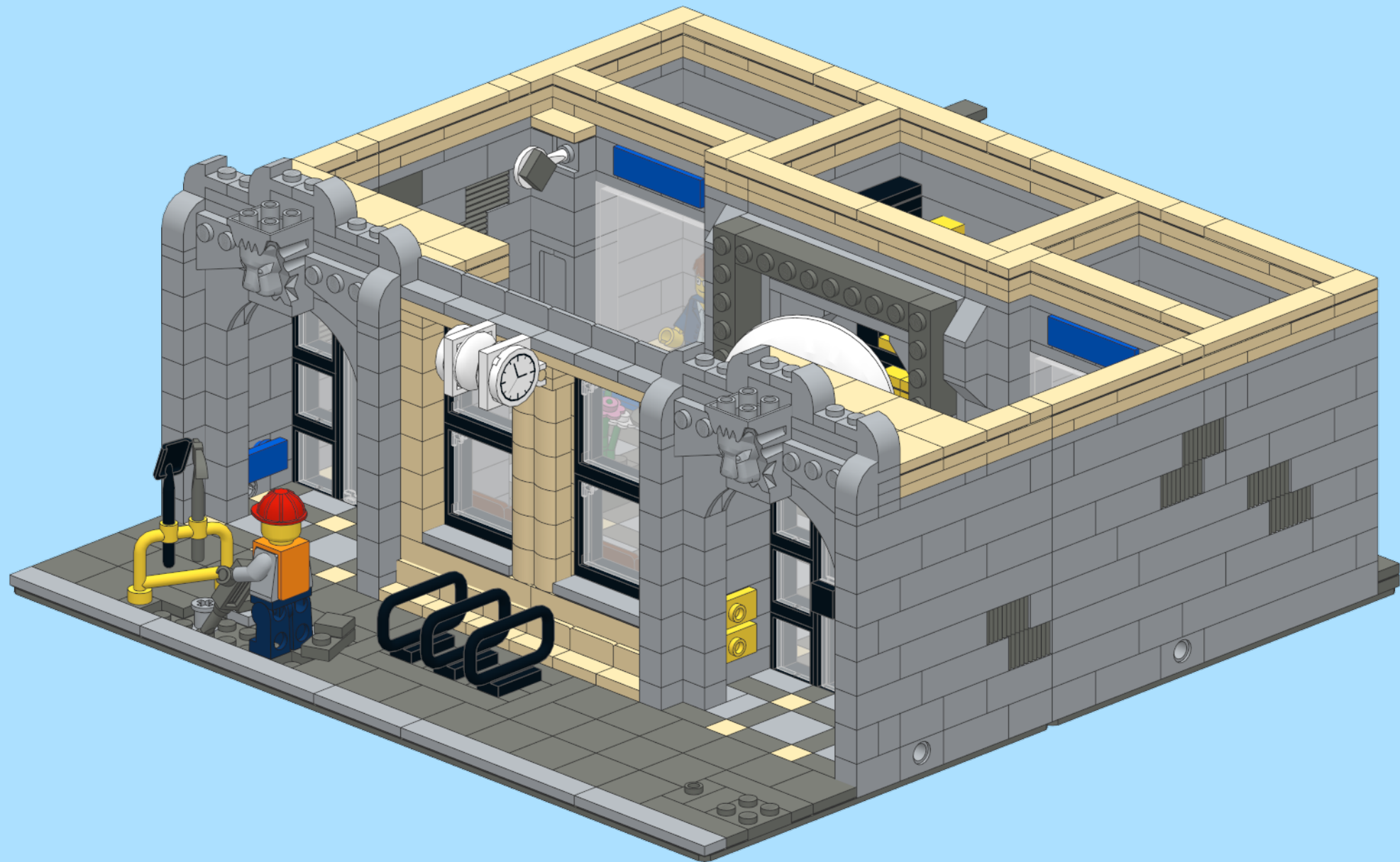
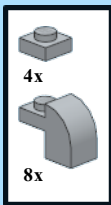

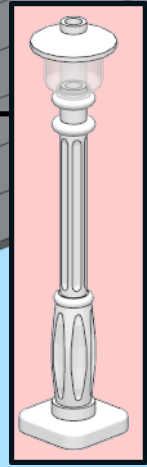
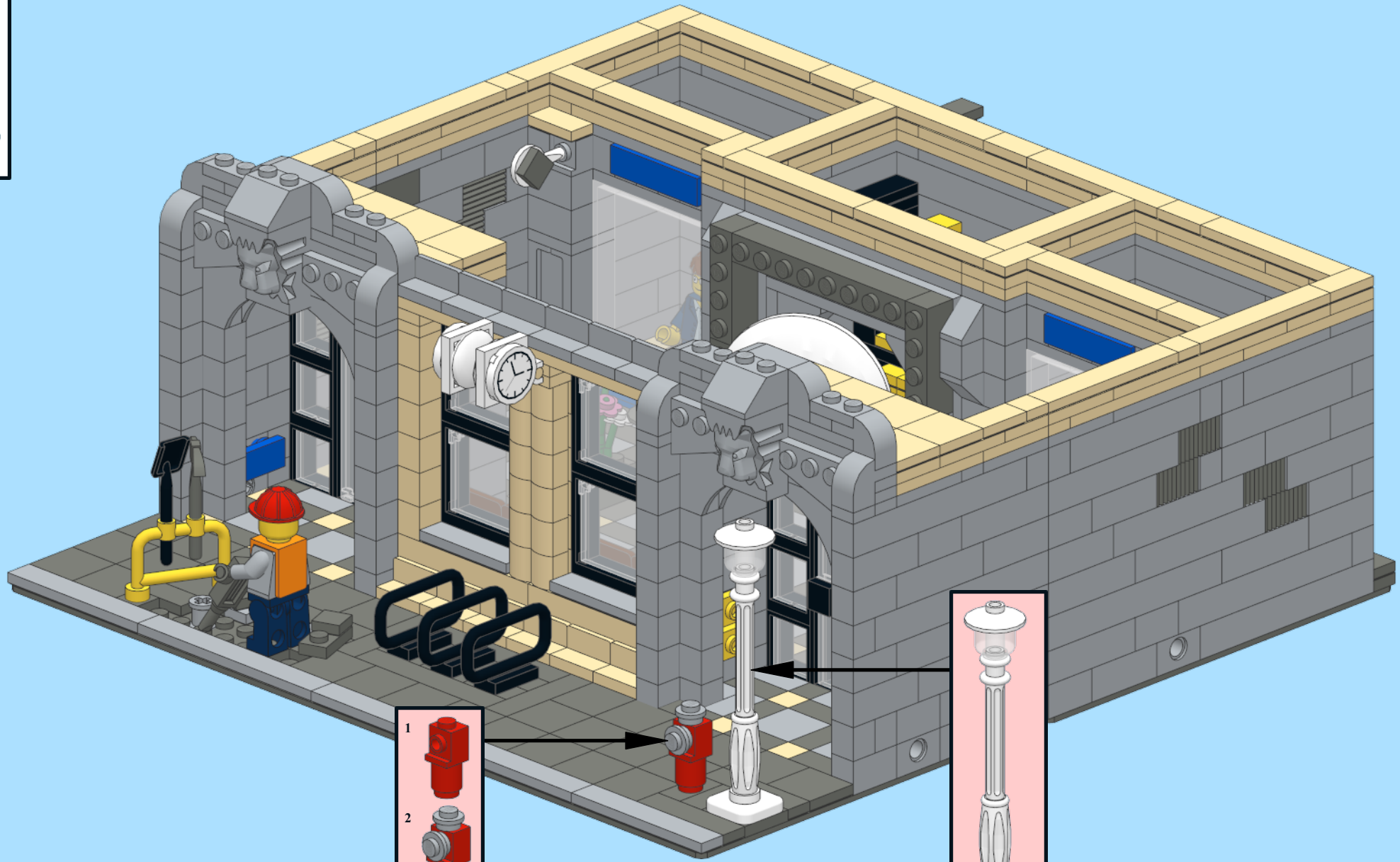
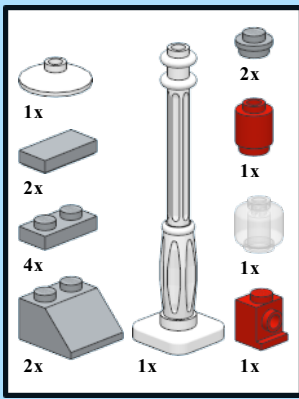

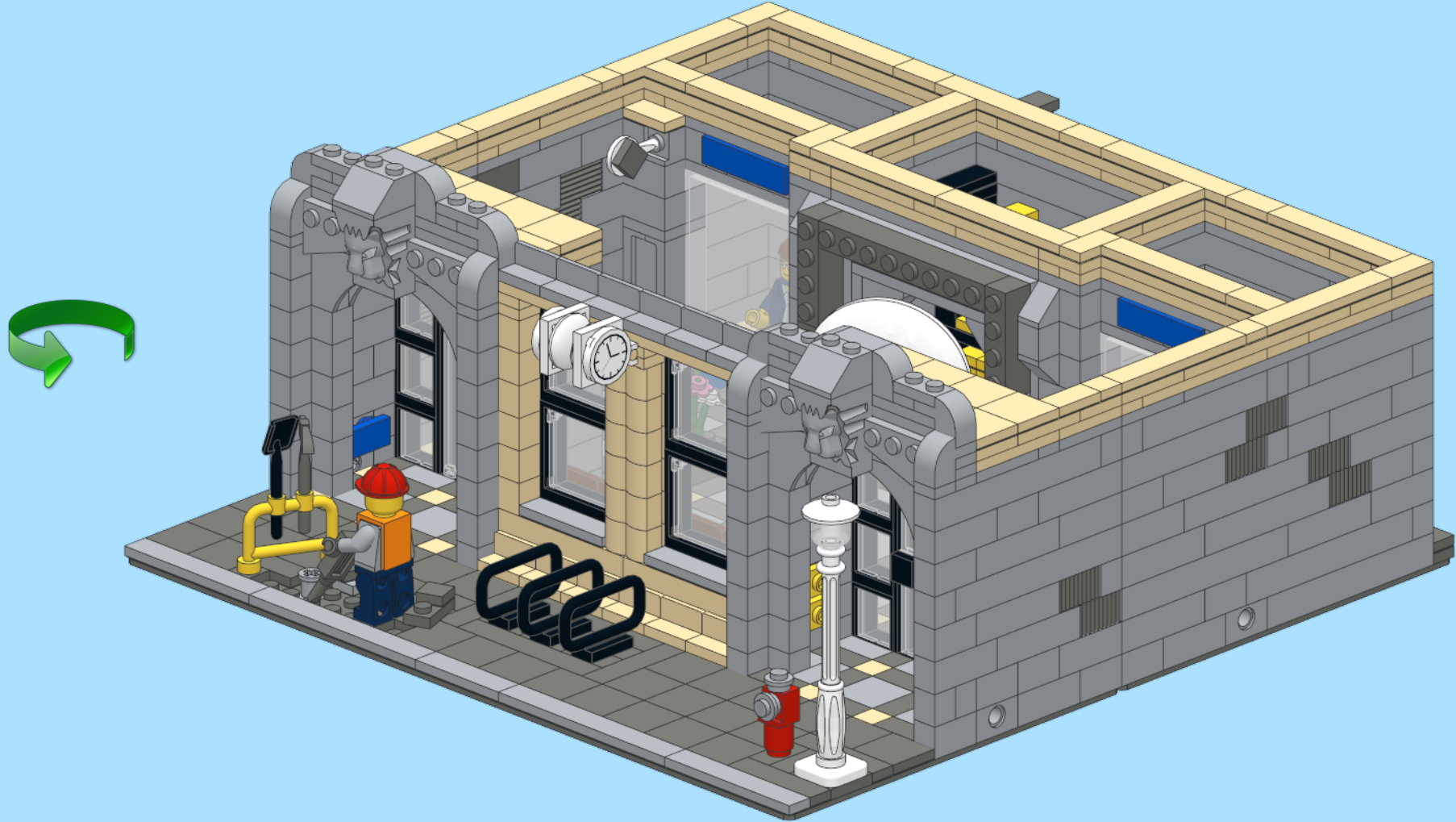

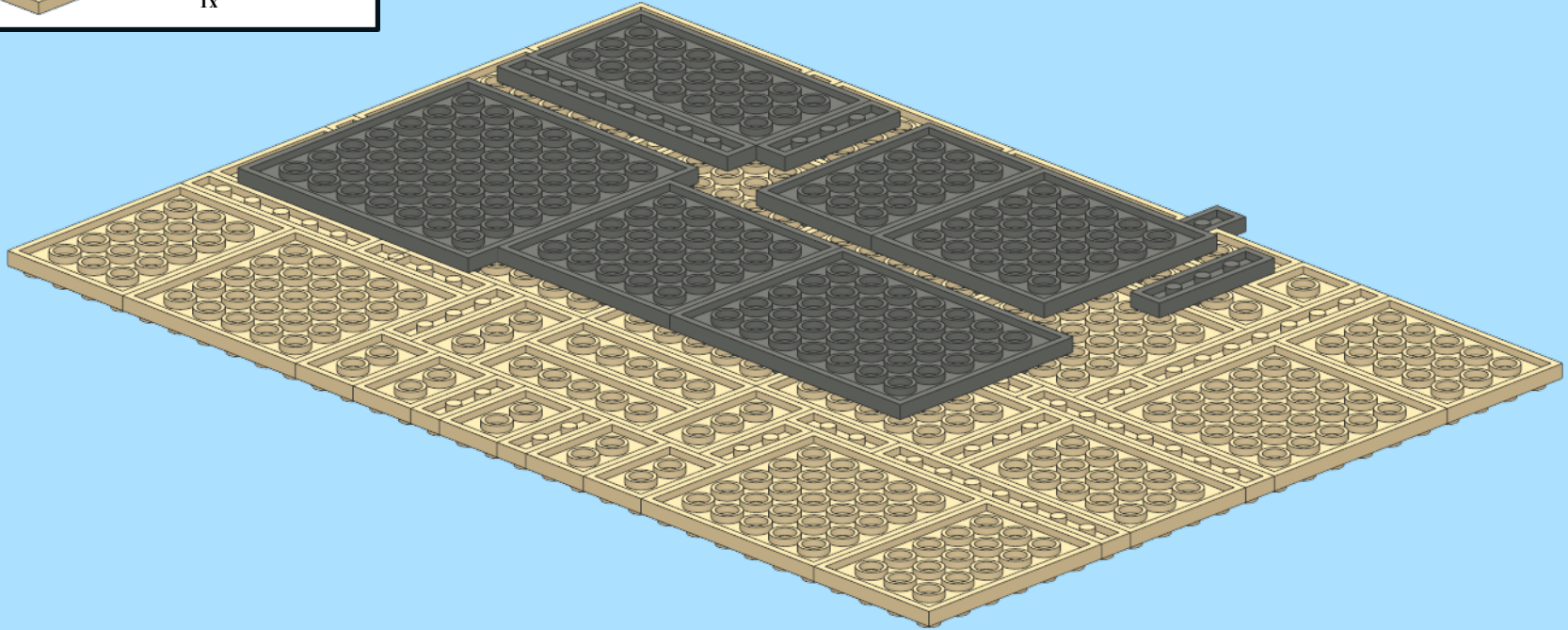
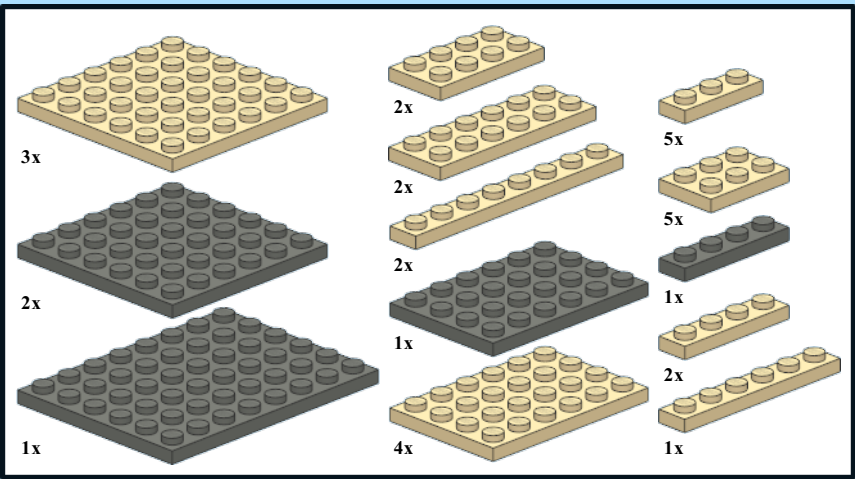

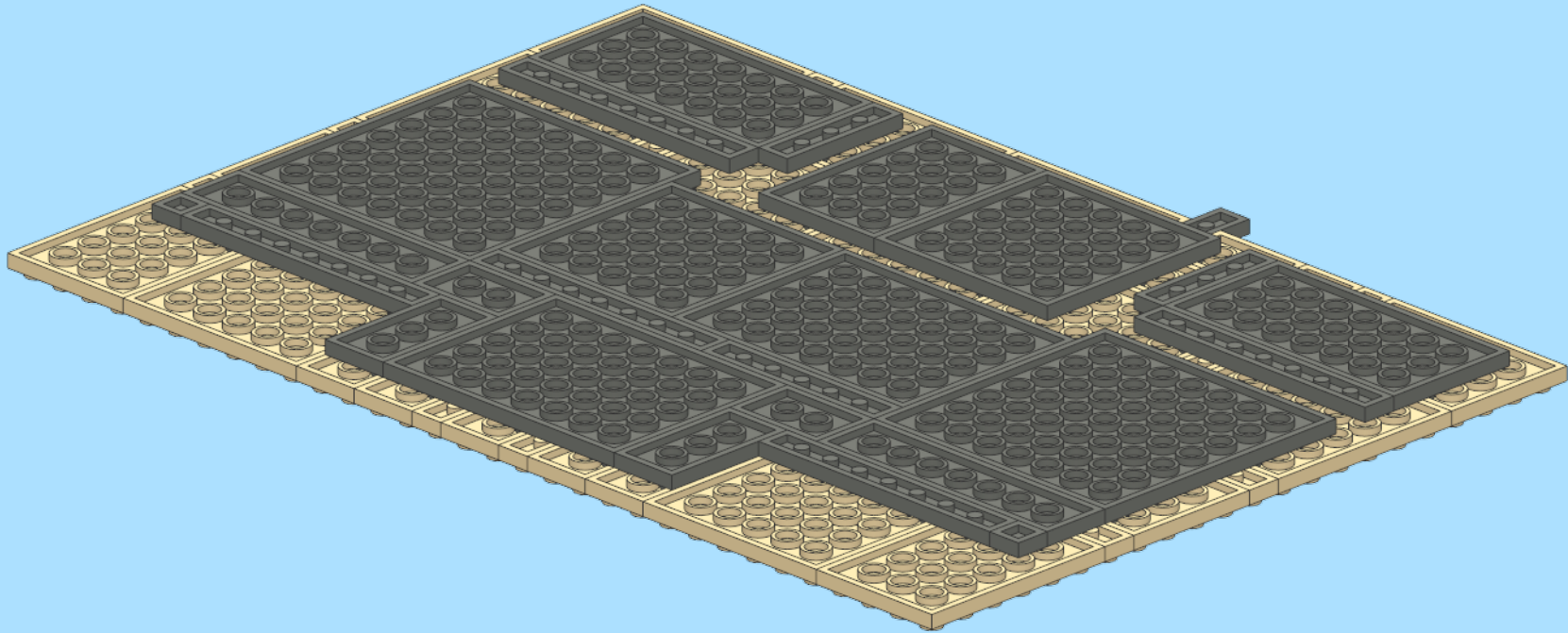
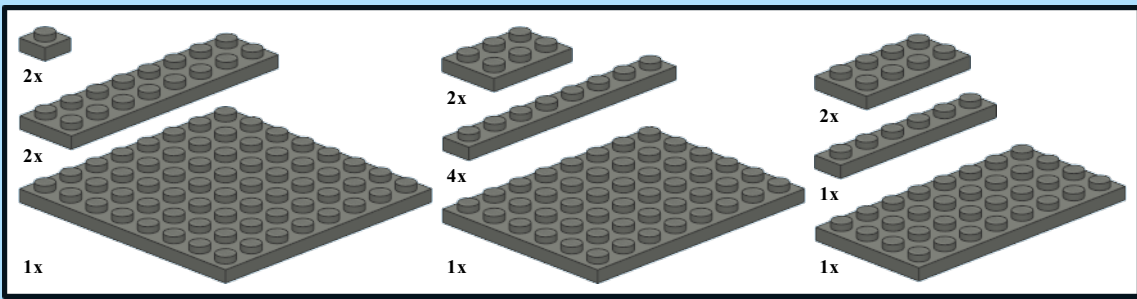

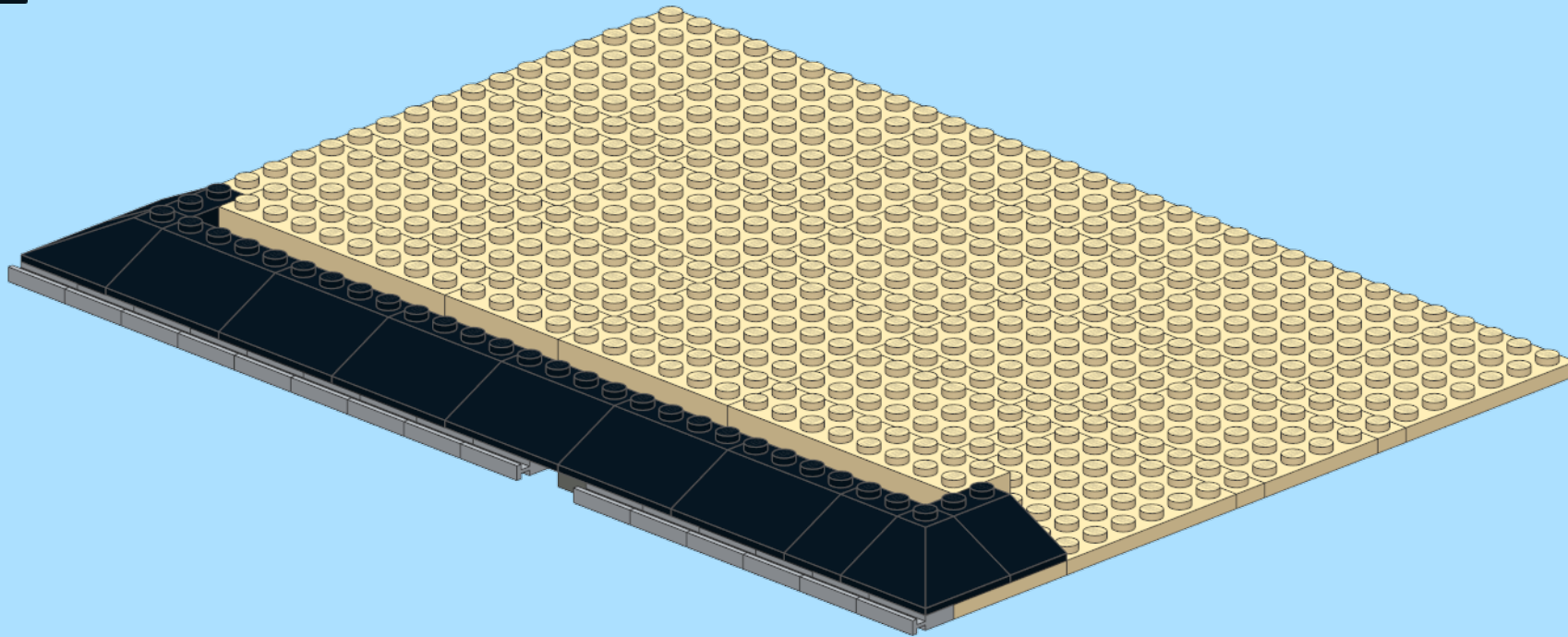
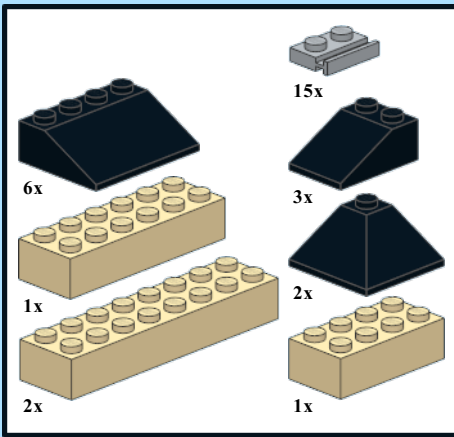

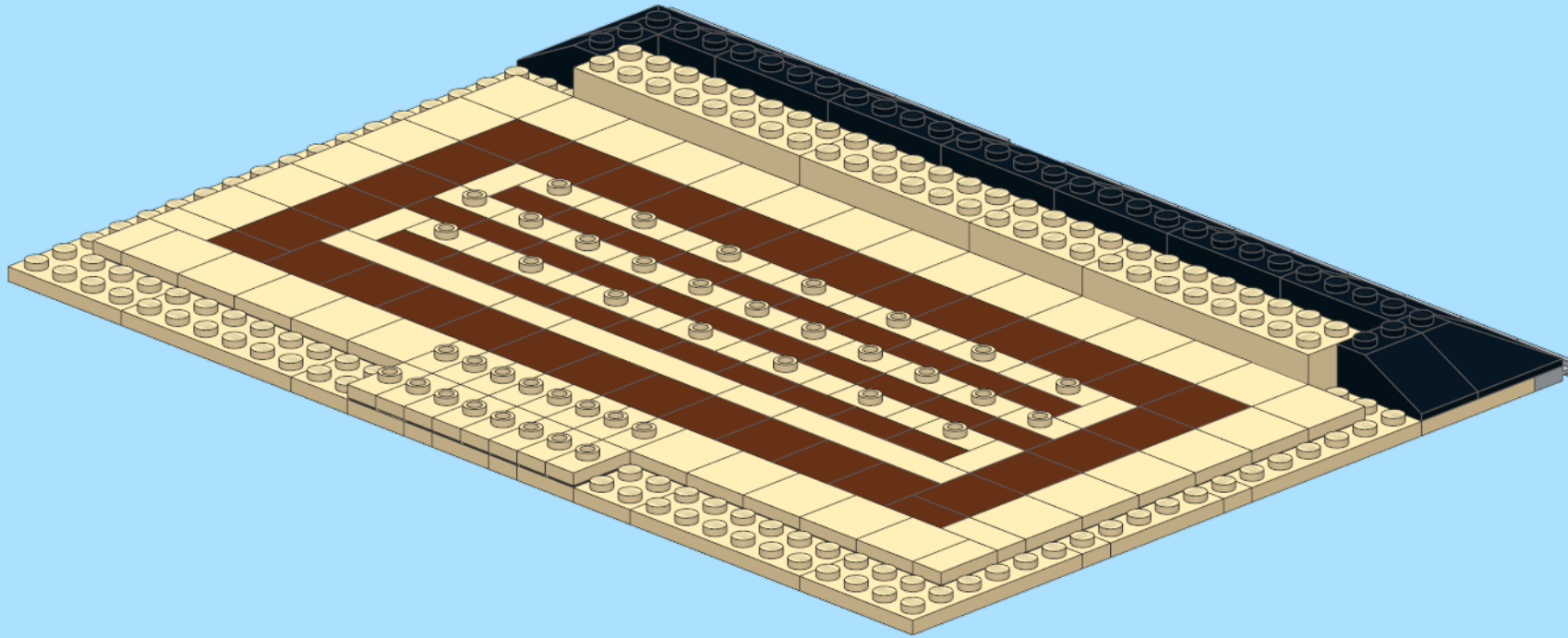
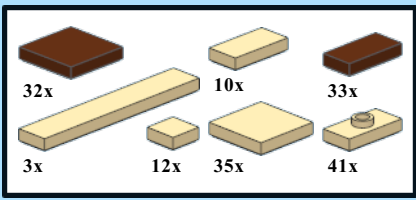

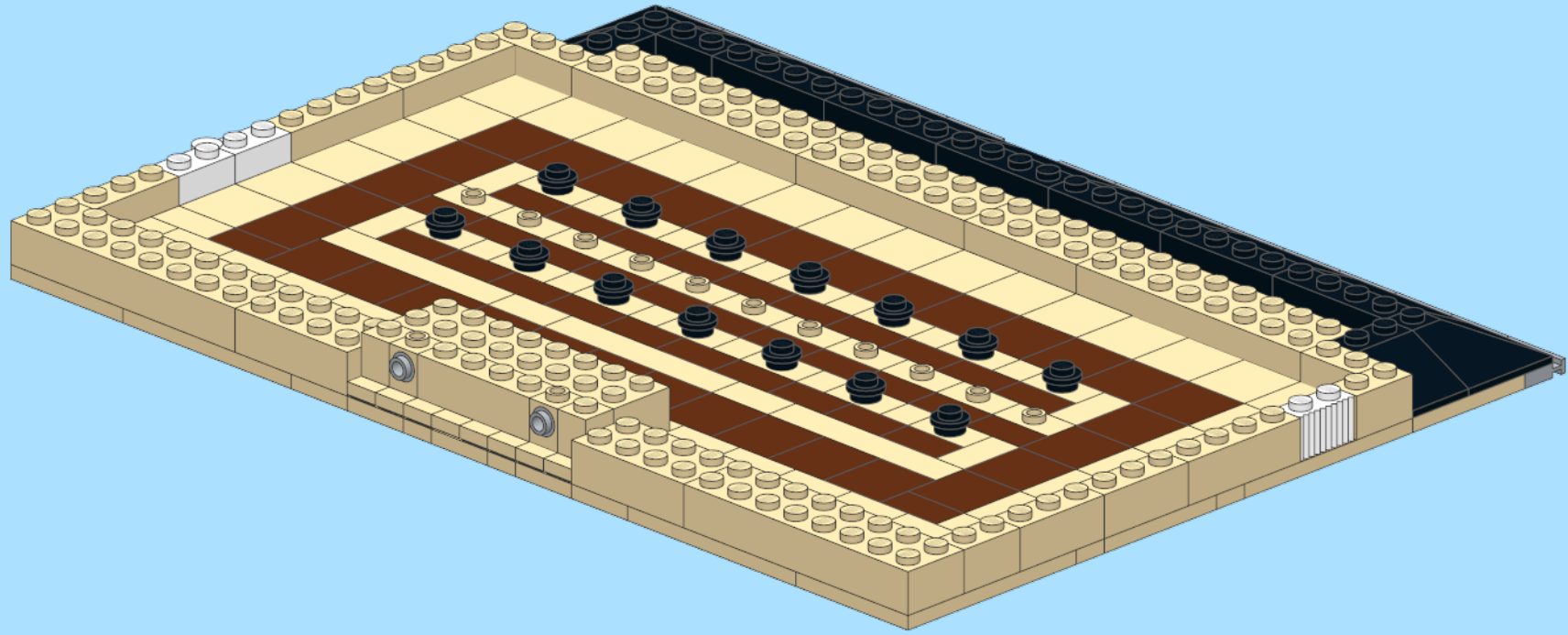
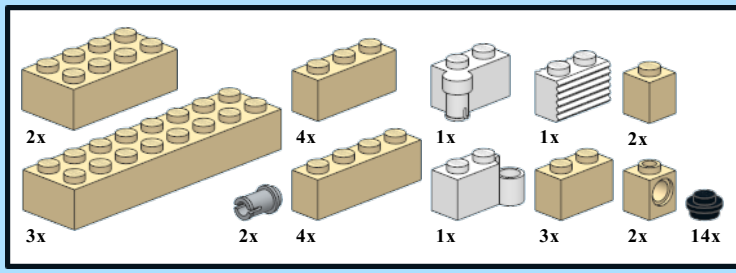

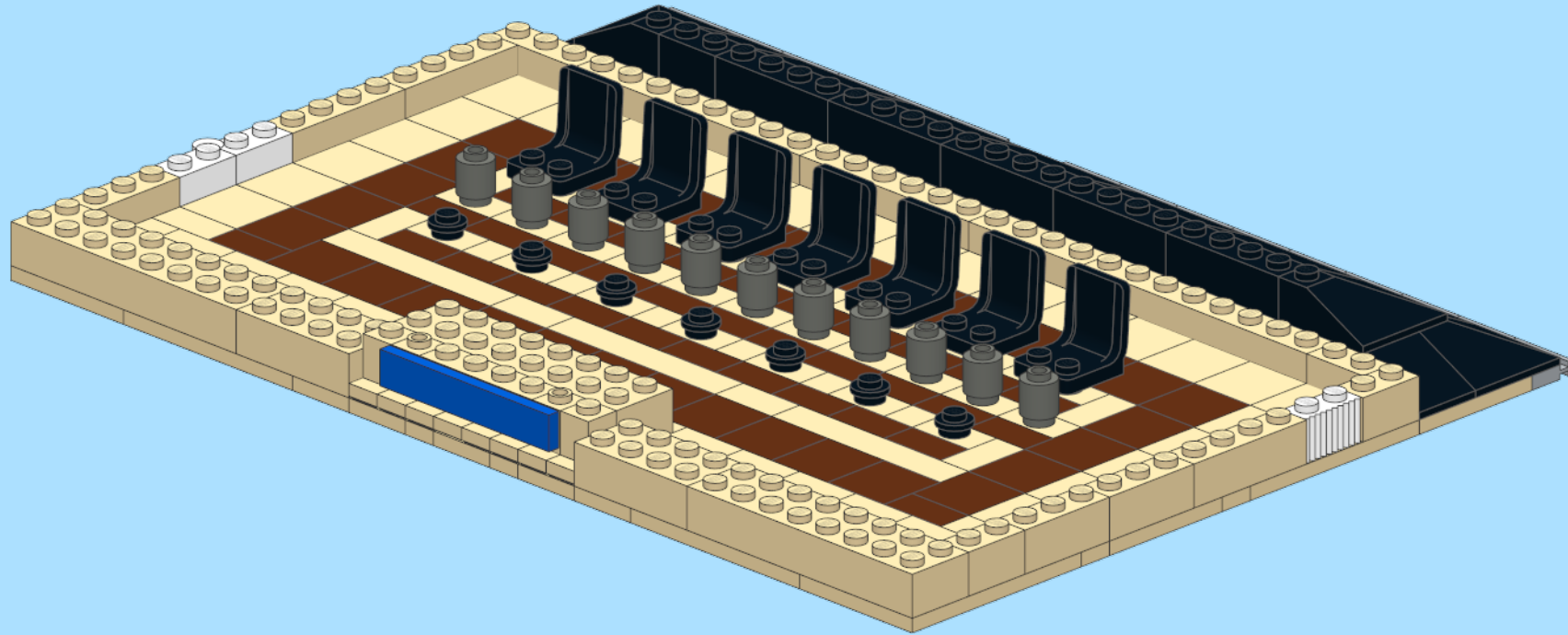
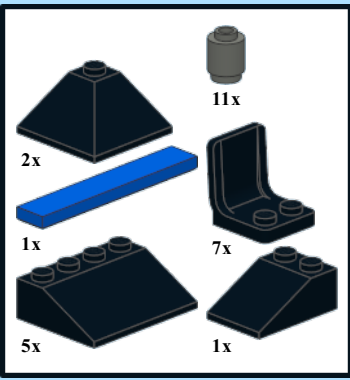

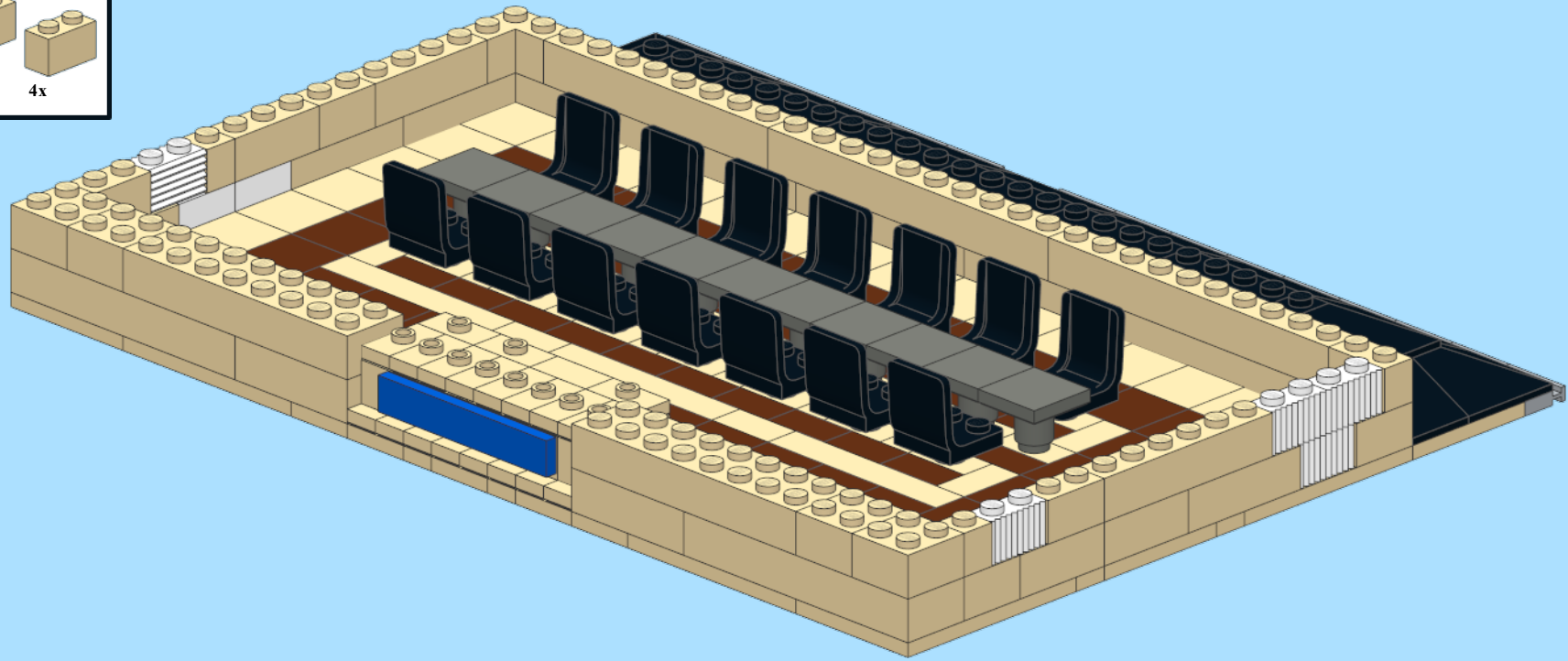
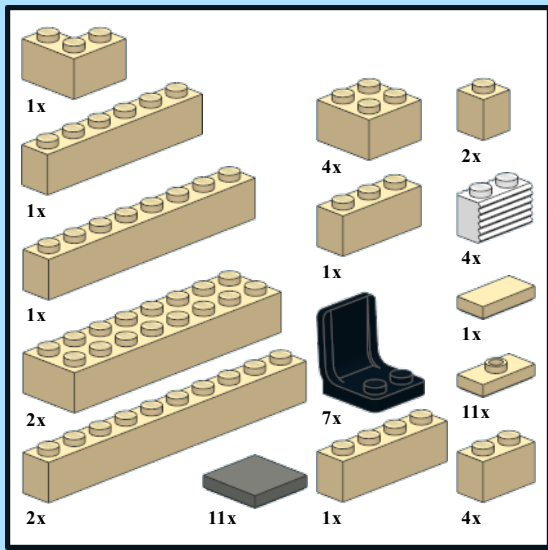

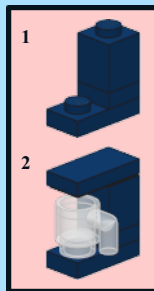
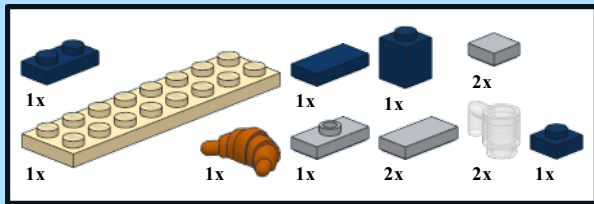

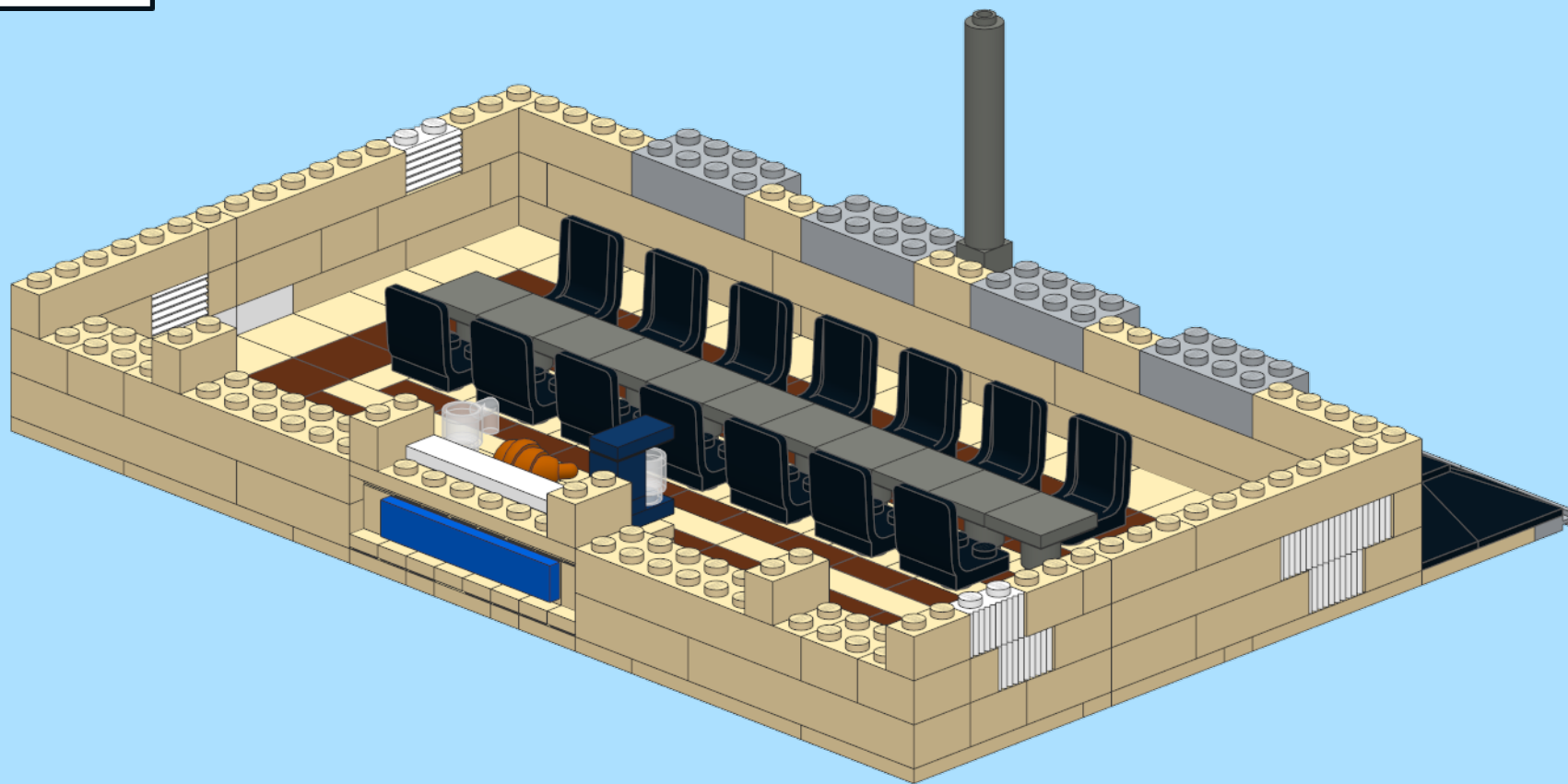
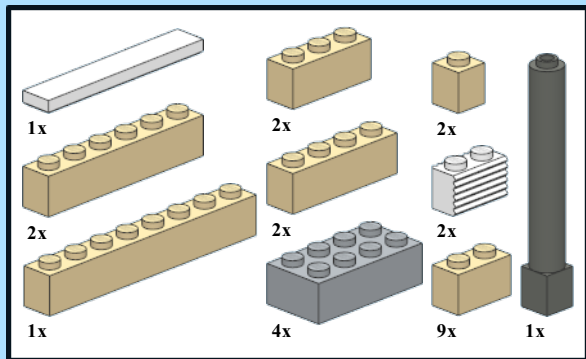

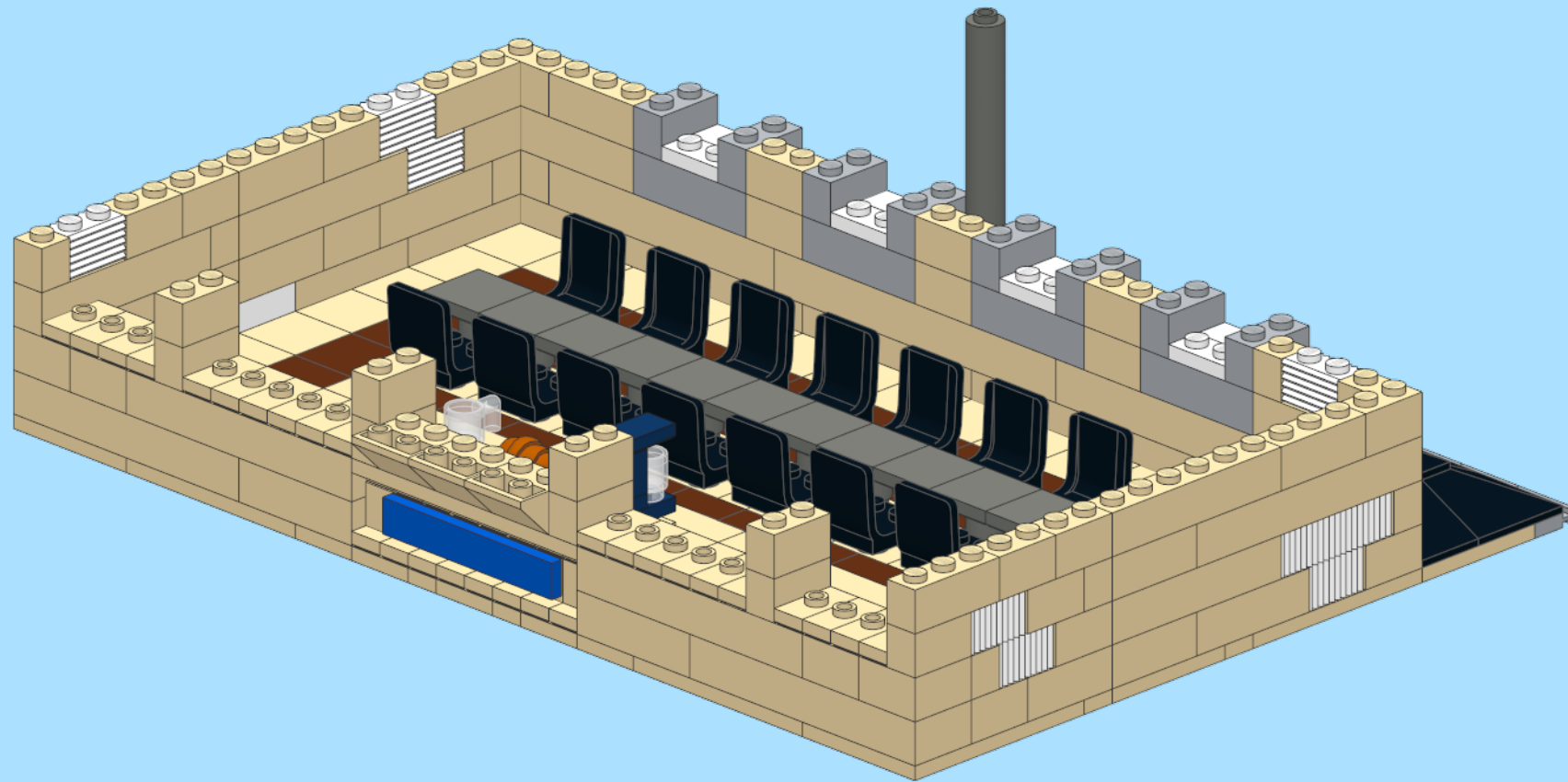
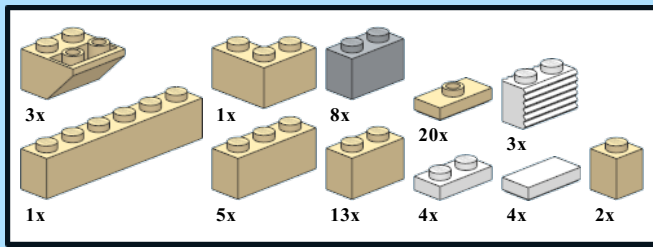

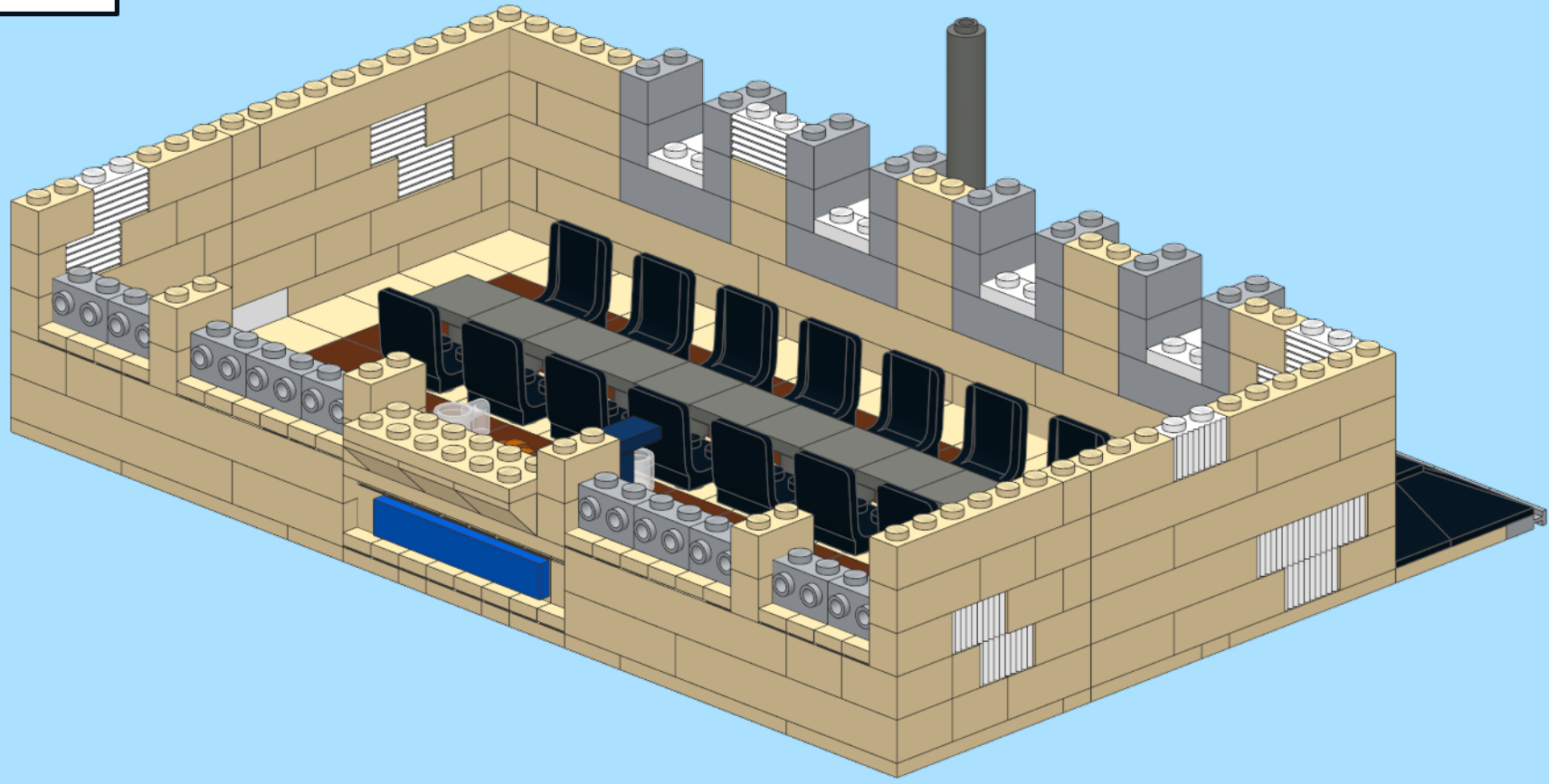
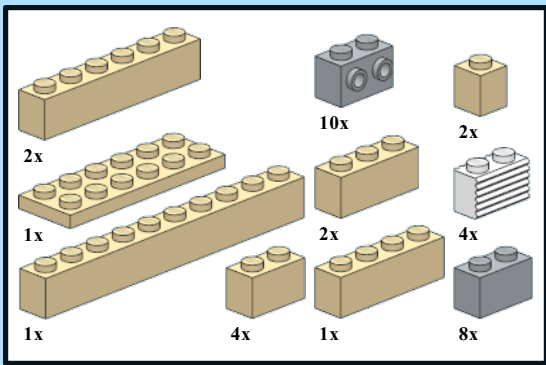

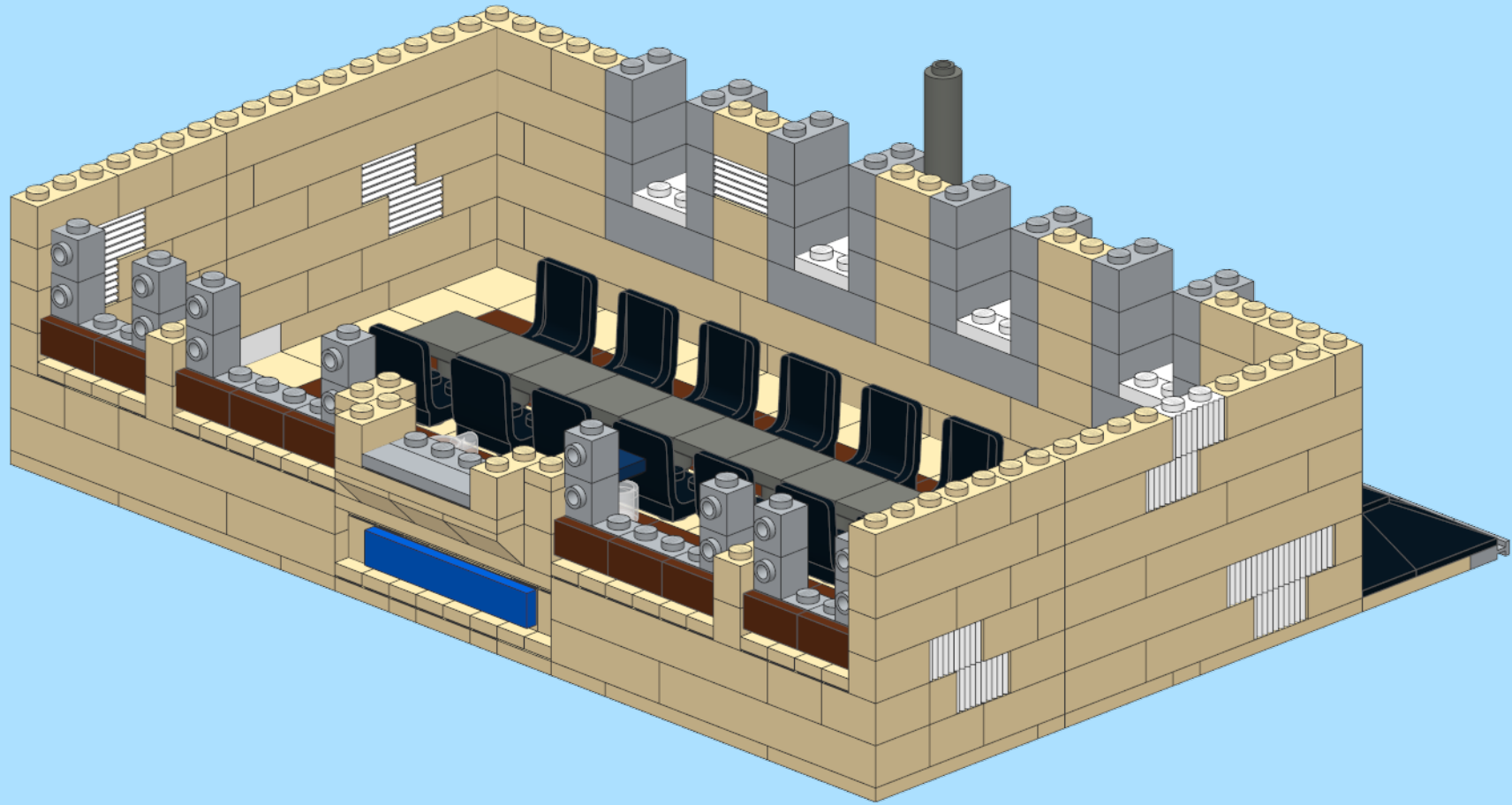
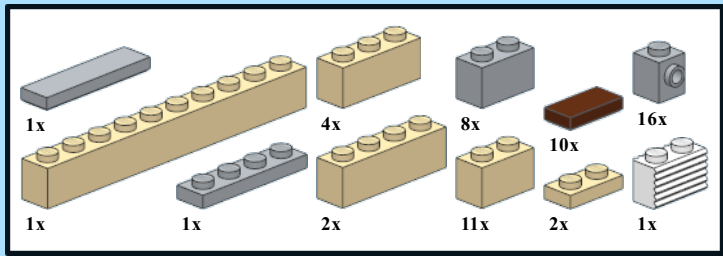

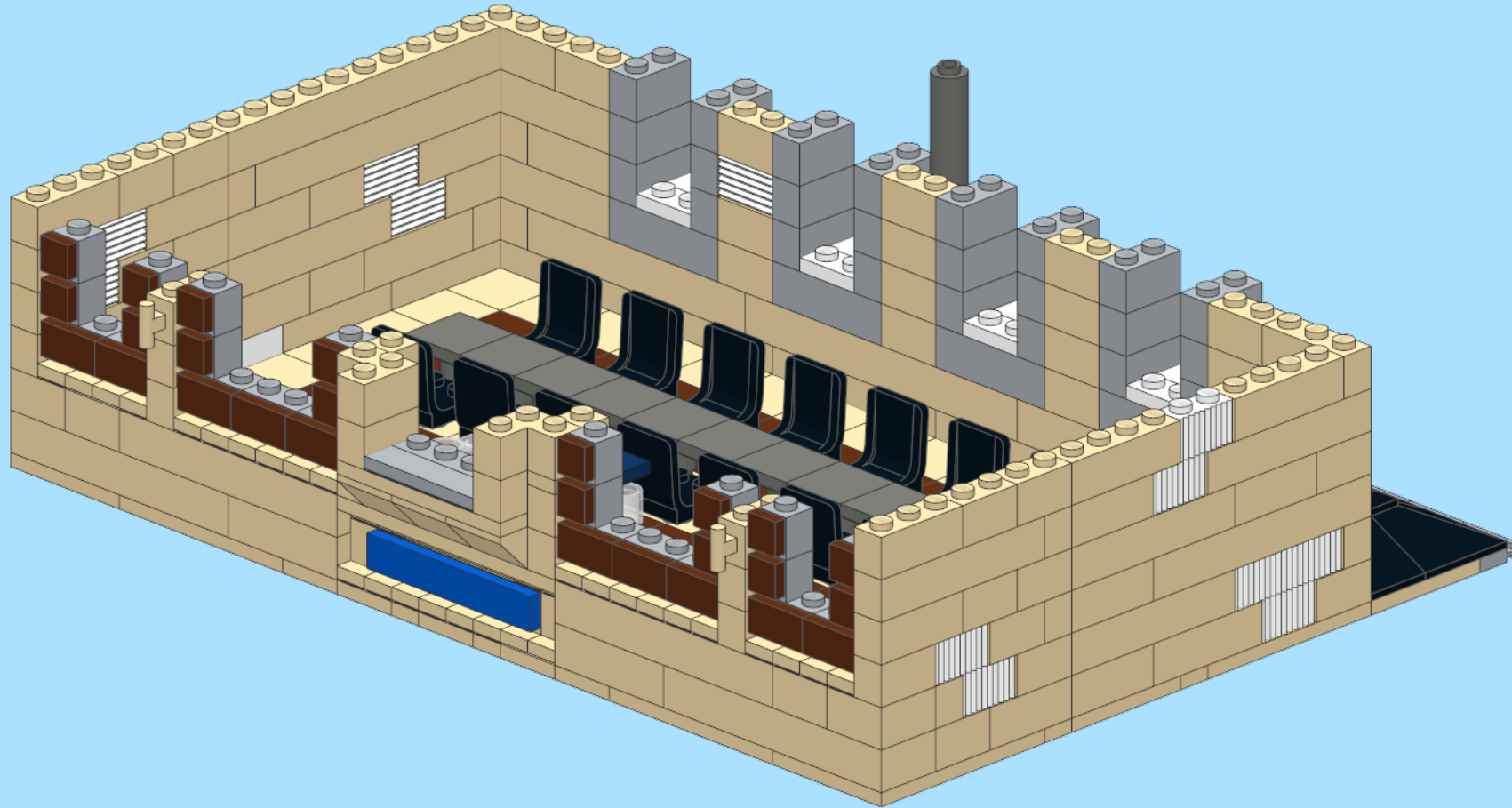
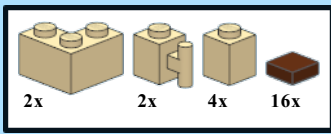

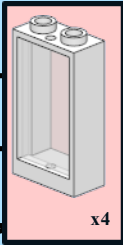
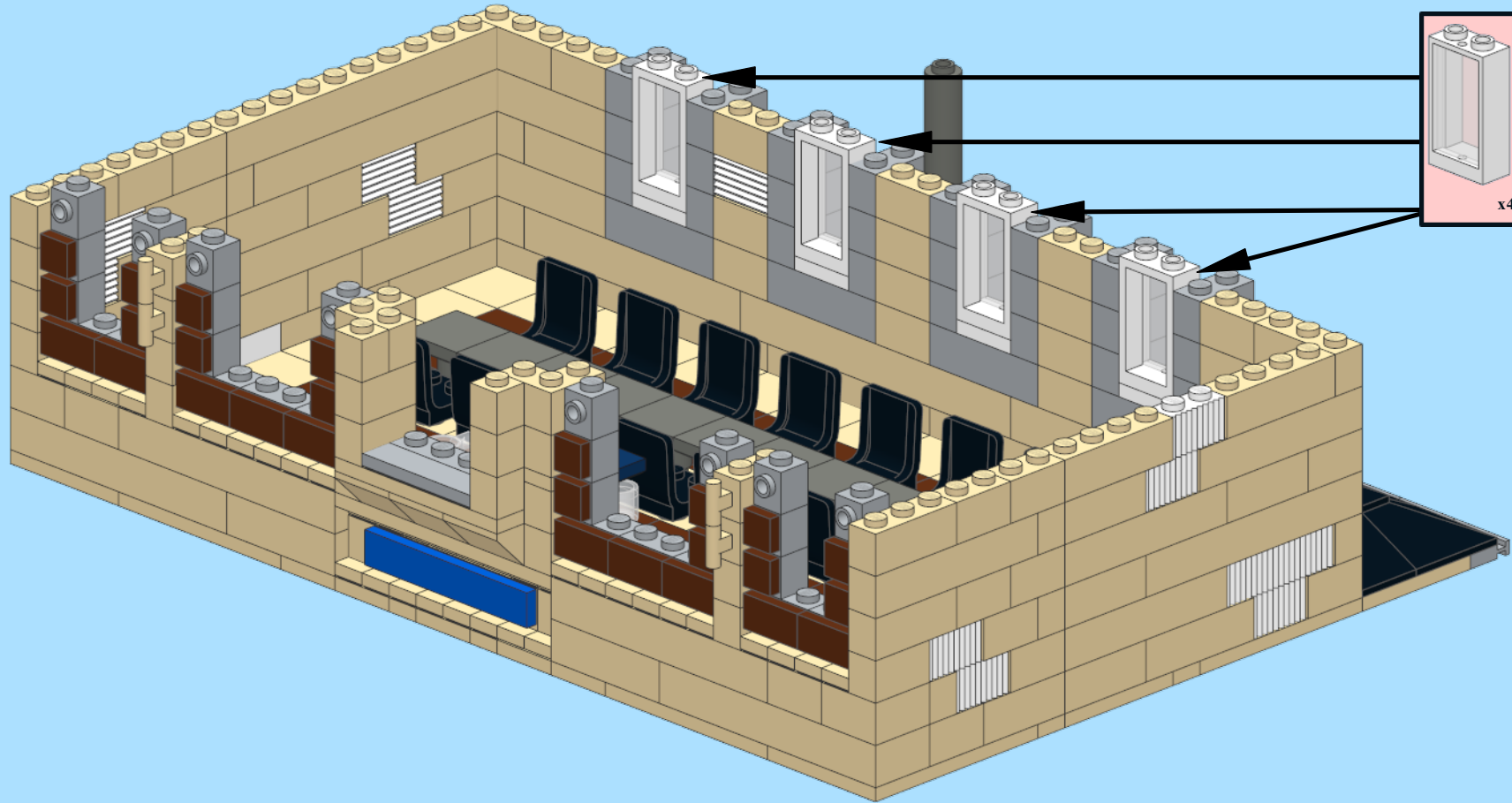
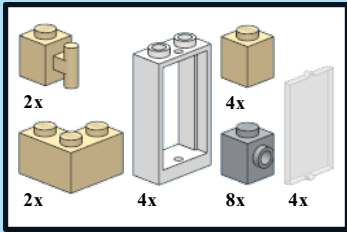

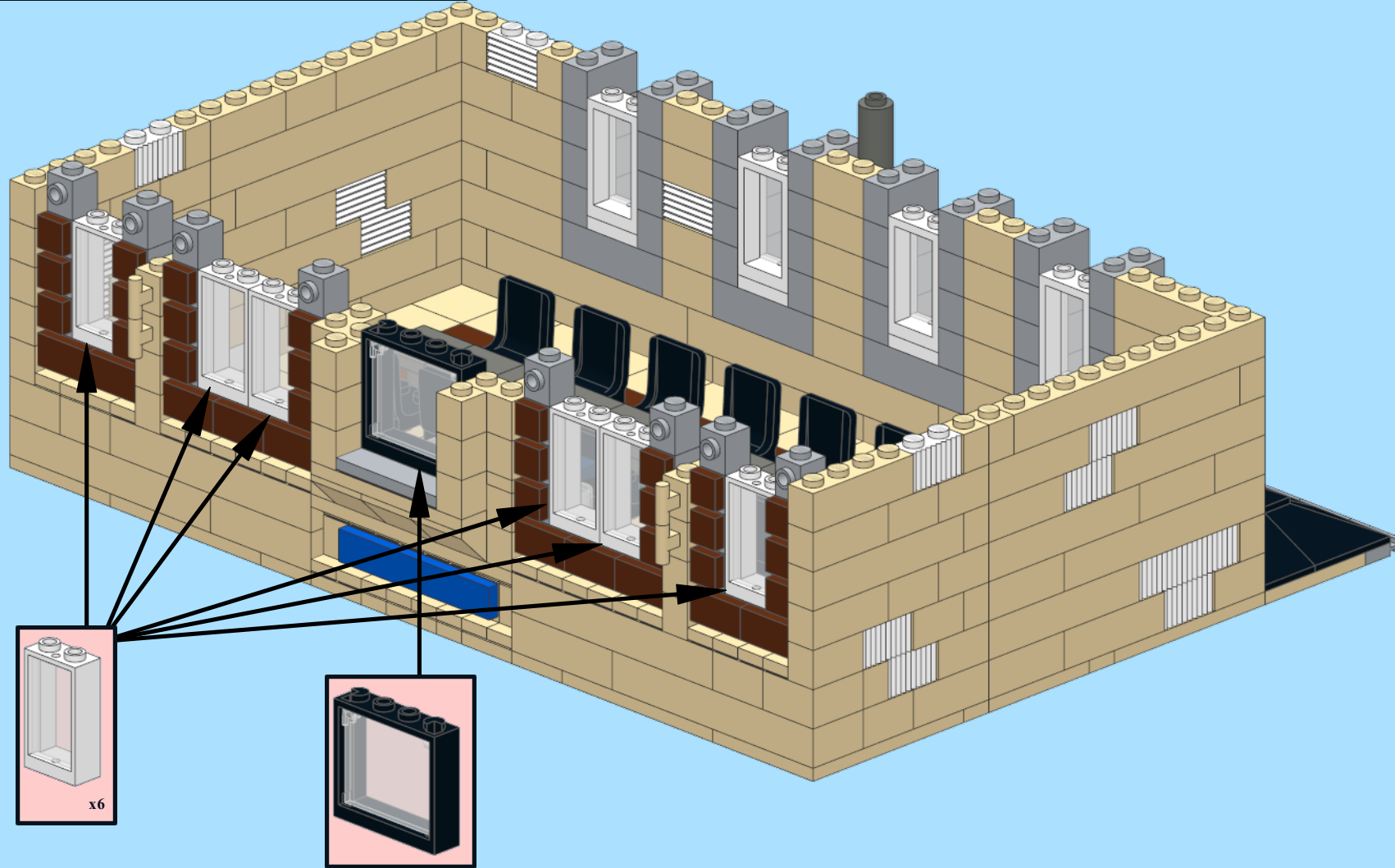
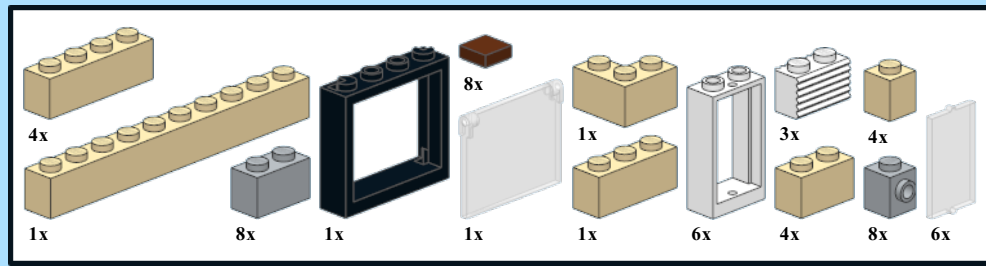

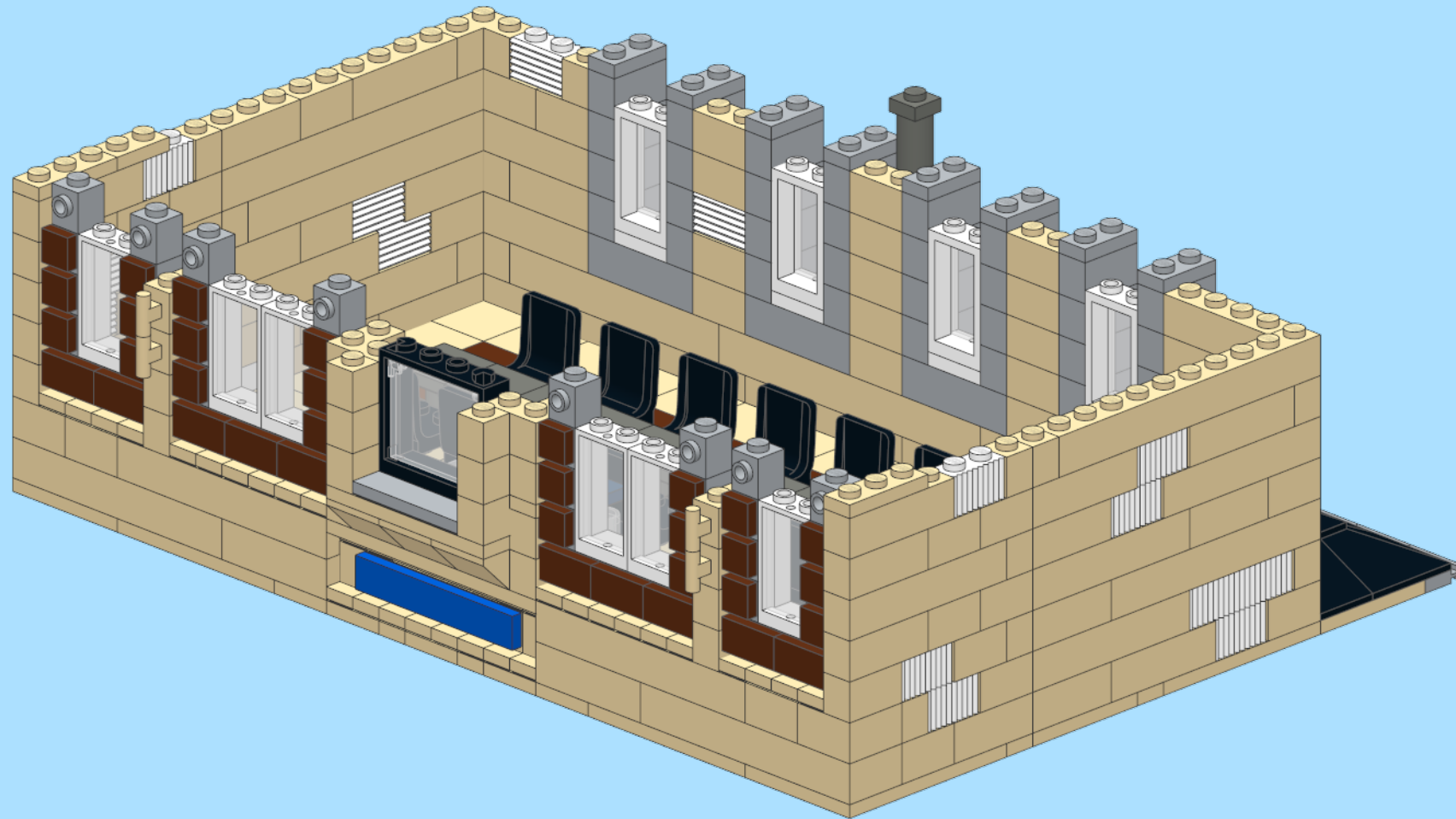
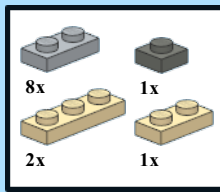

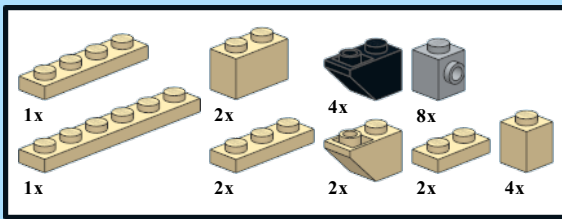

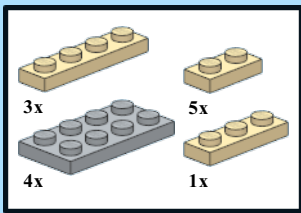

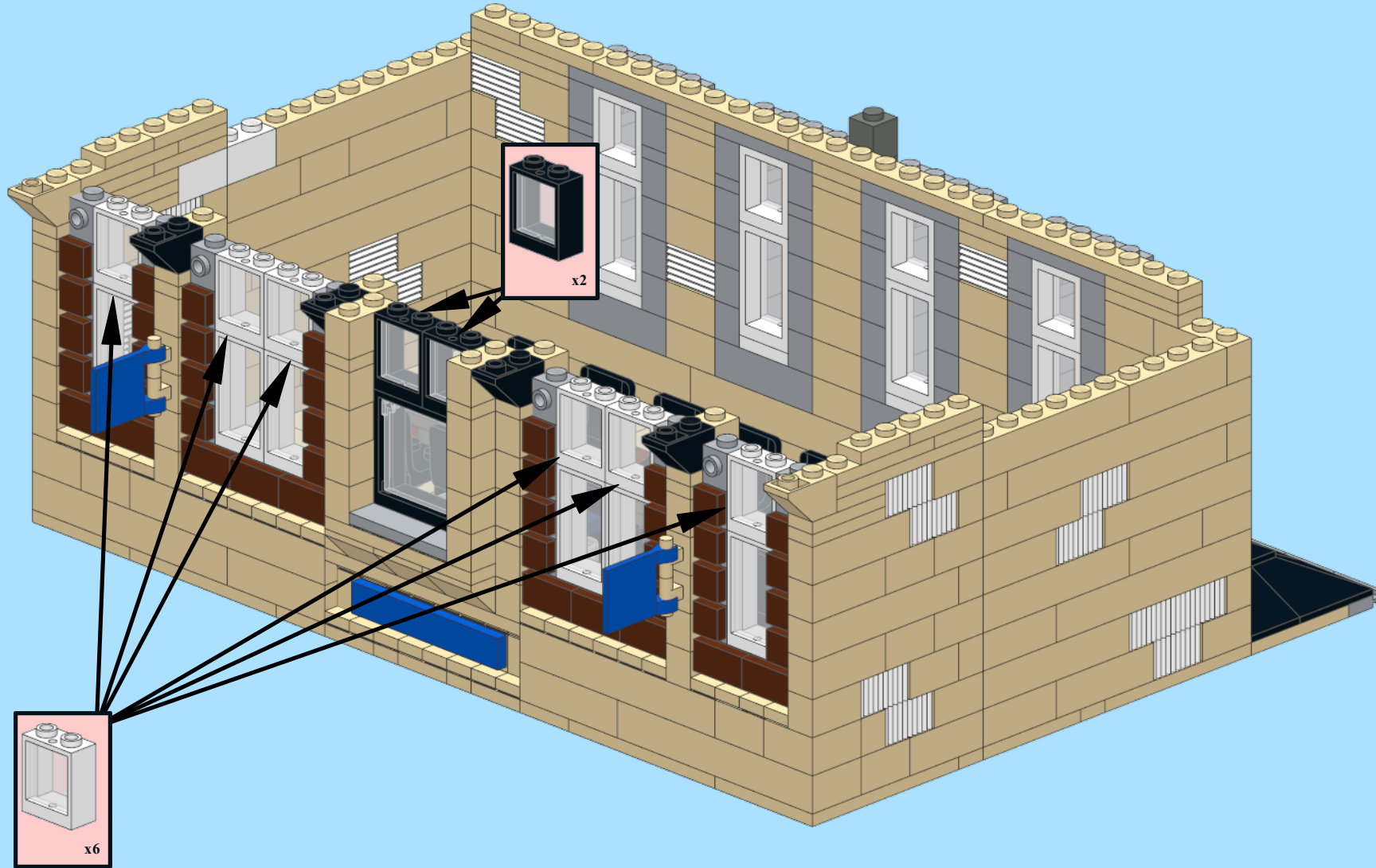
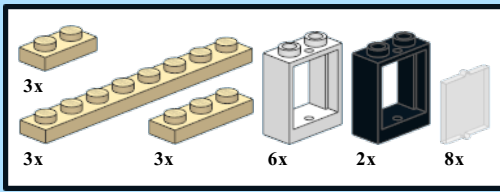

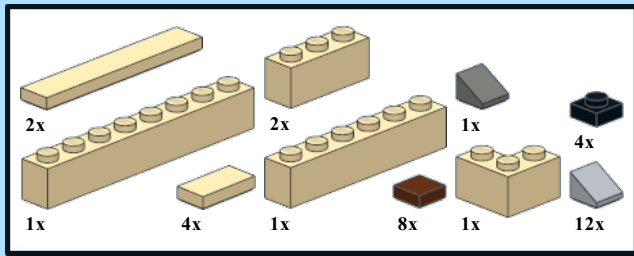

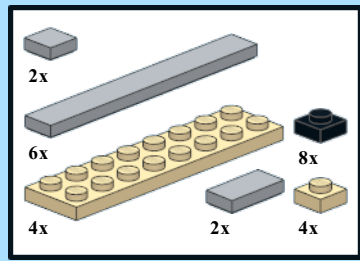

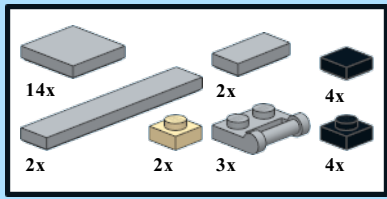

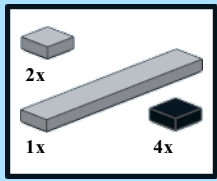

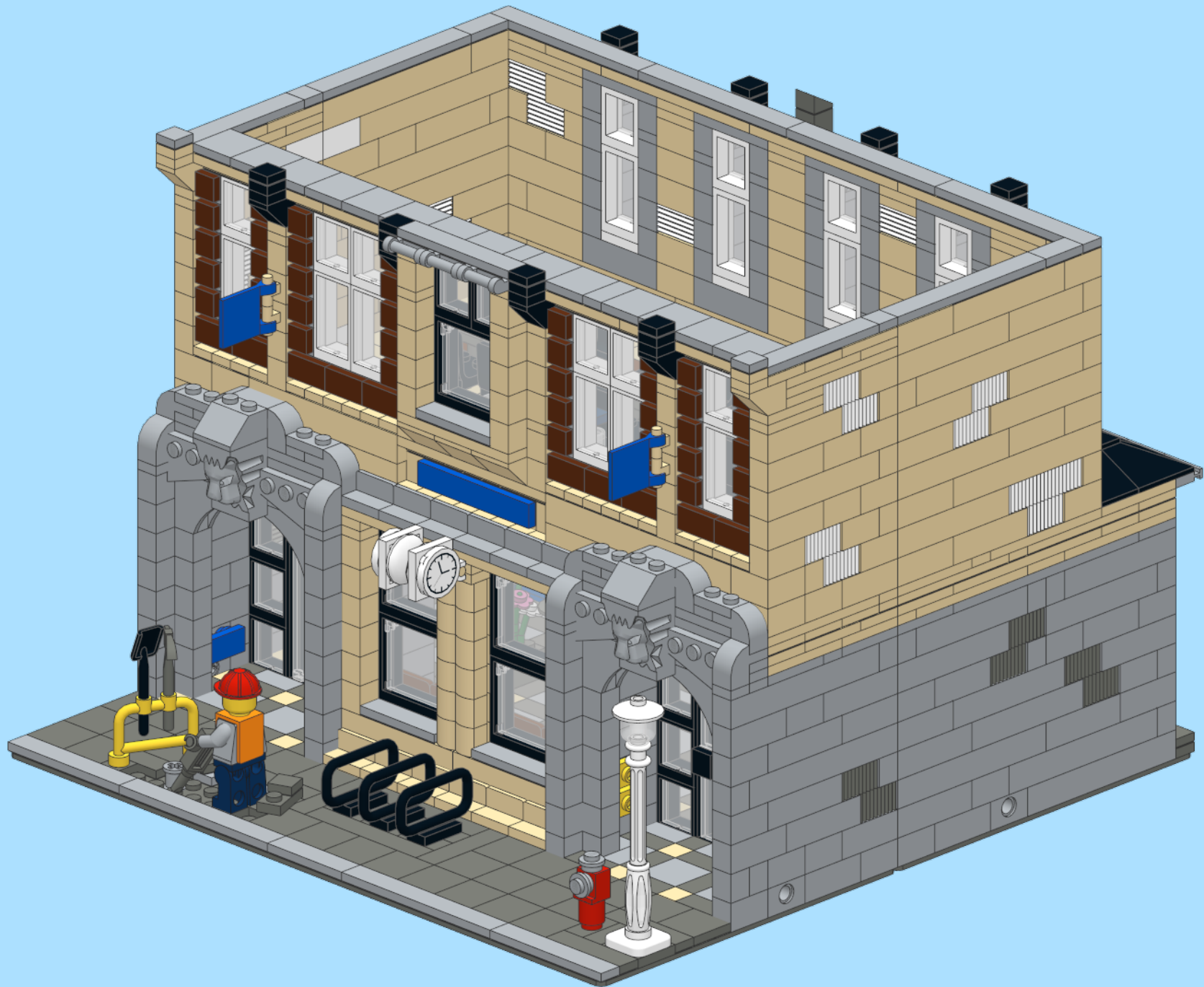

1

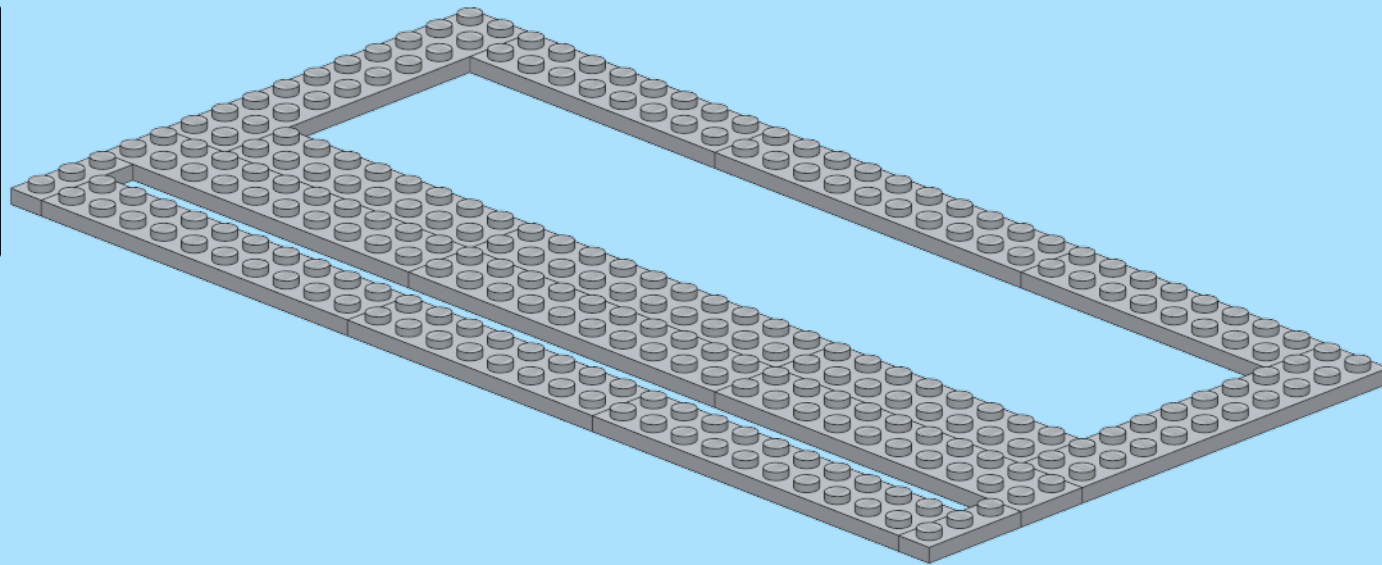
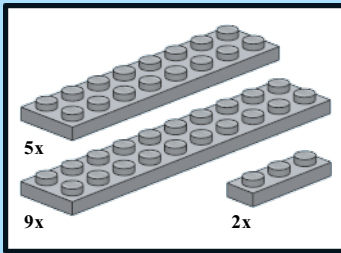

2

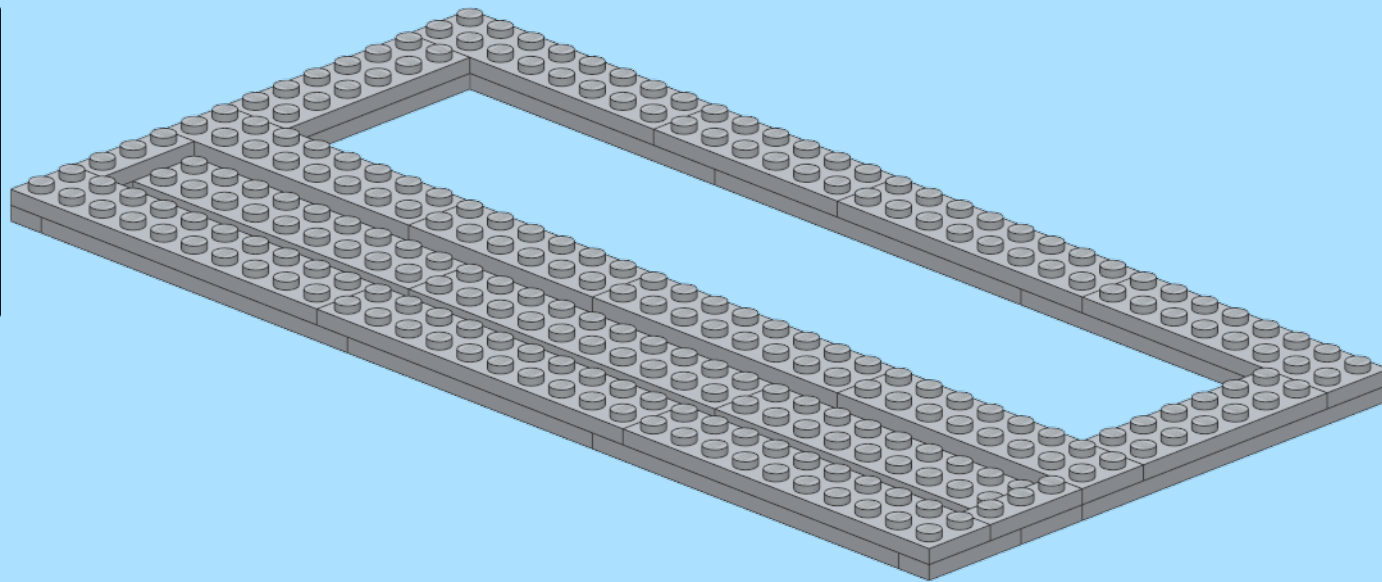
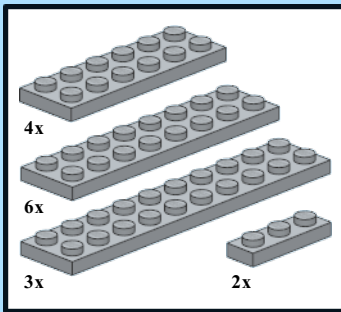

3

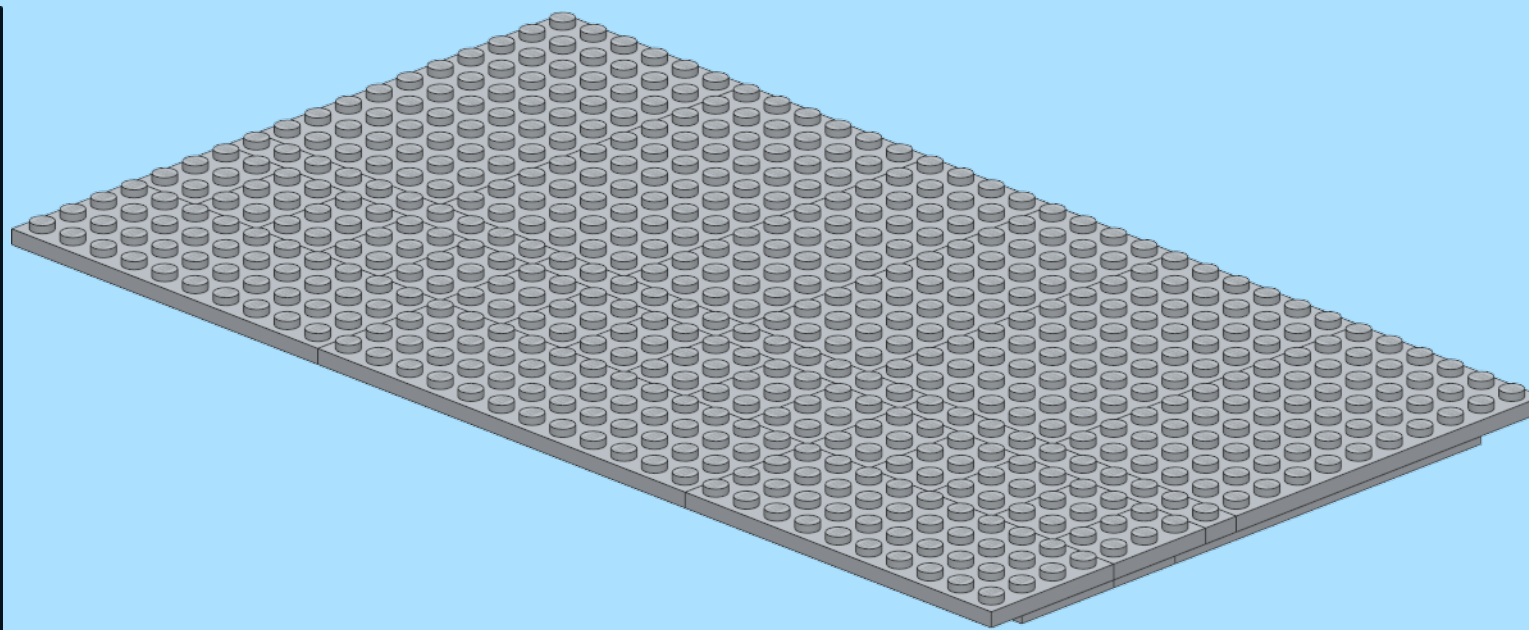
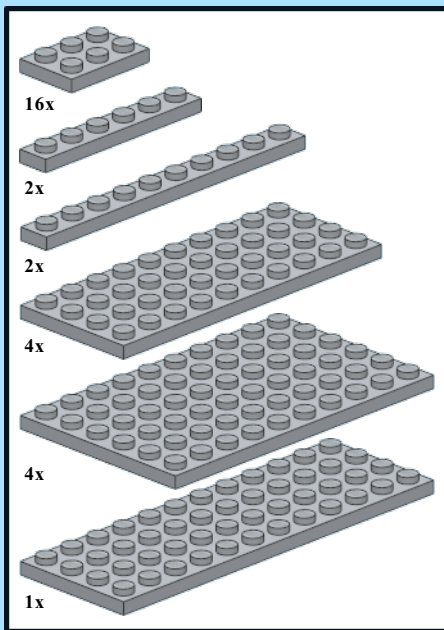

4

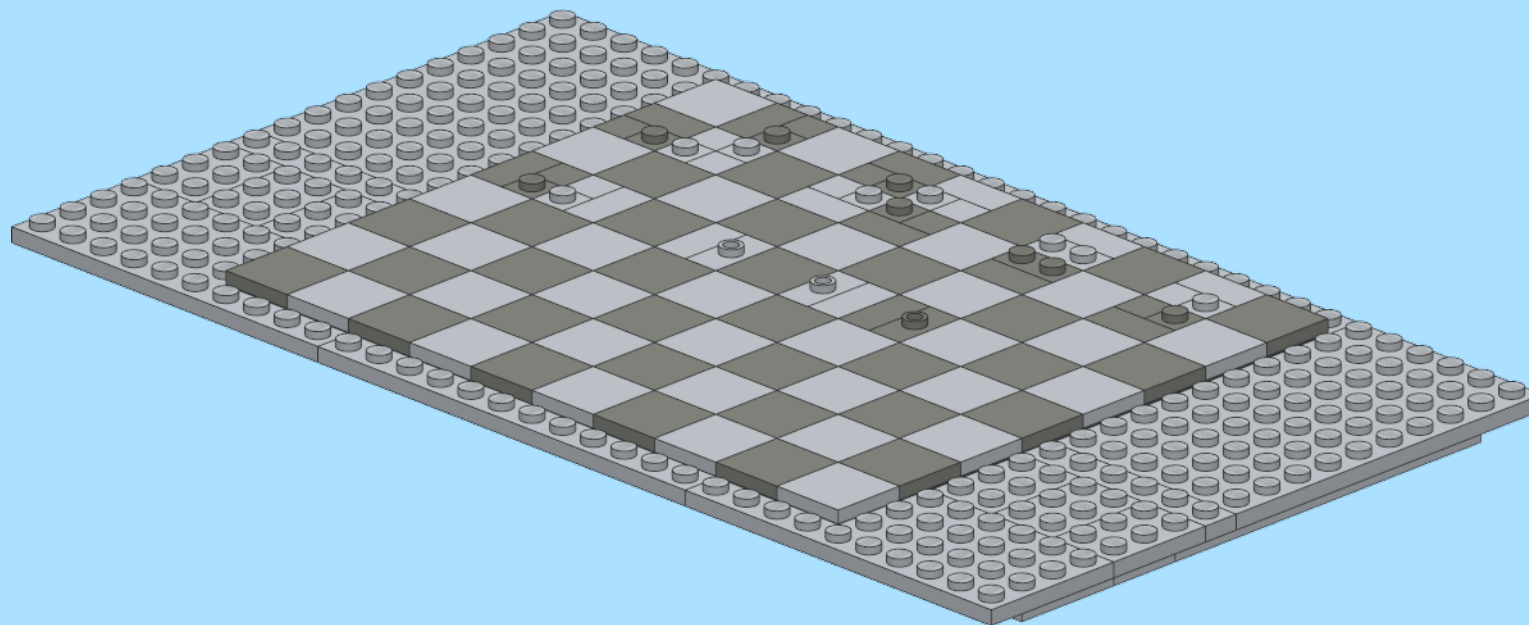
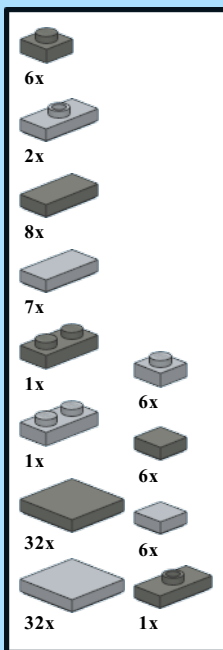

5

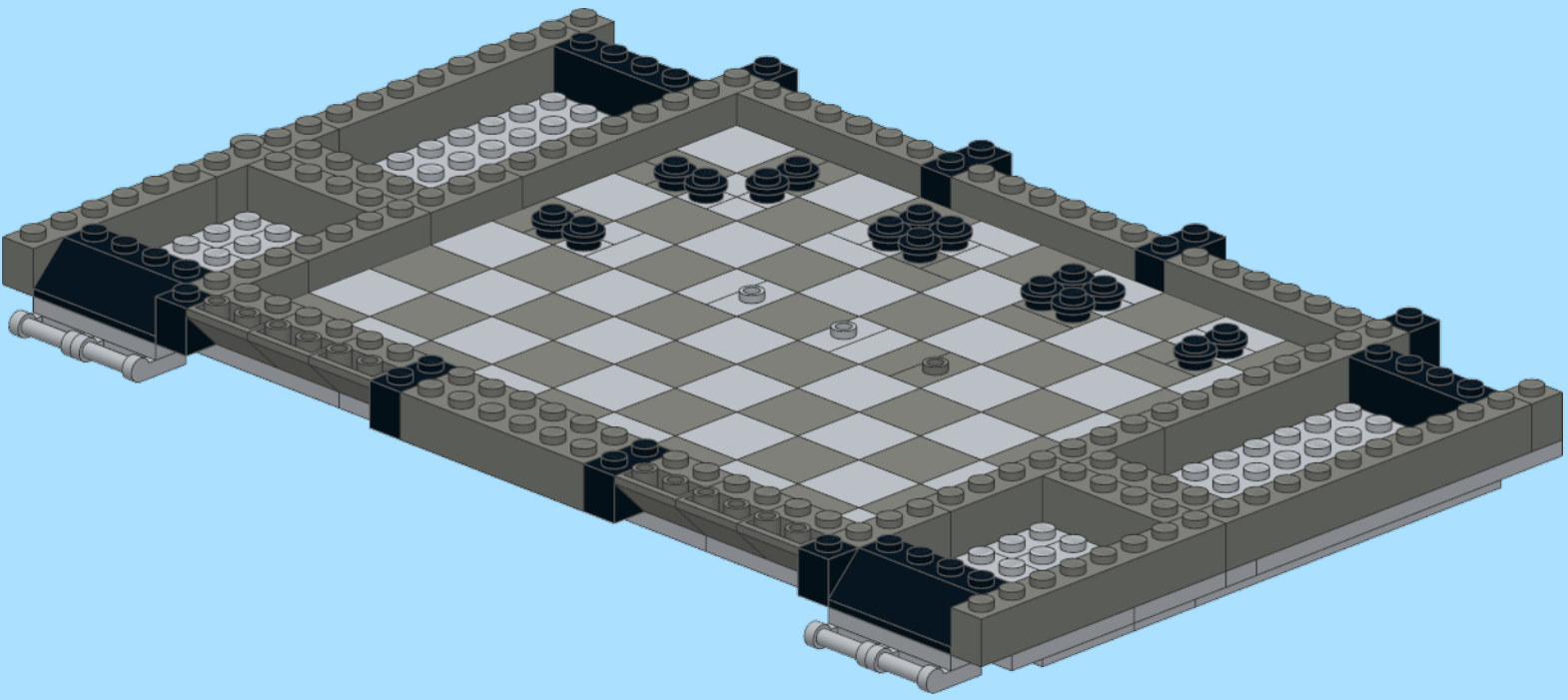
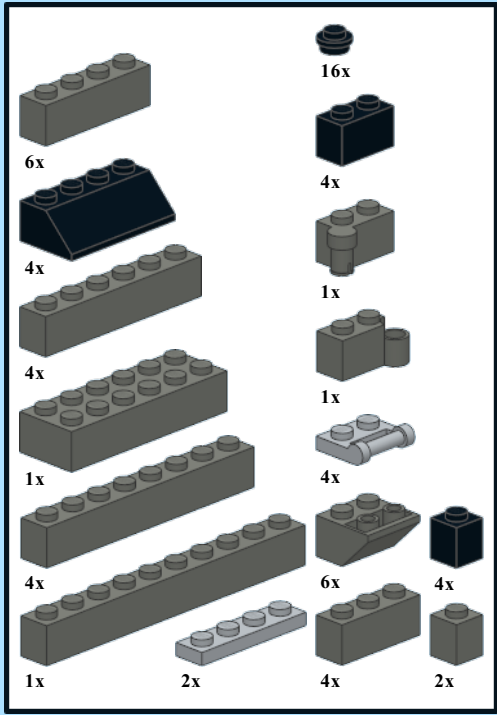

6

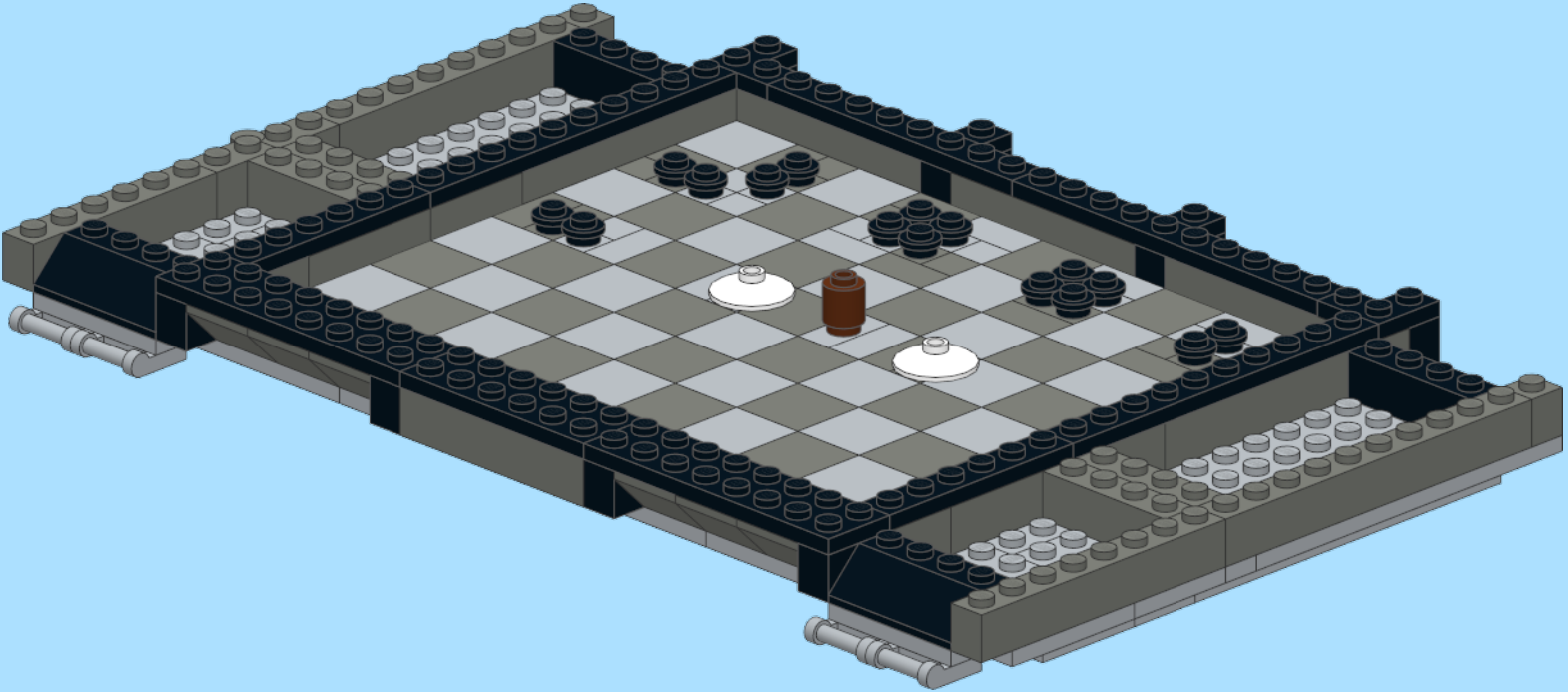
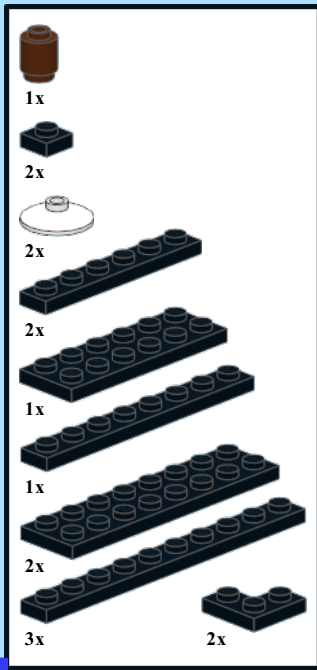

7

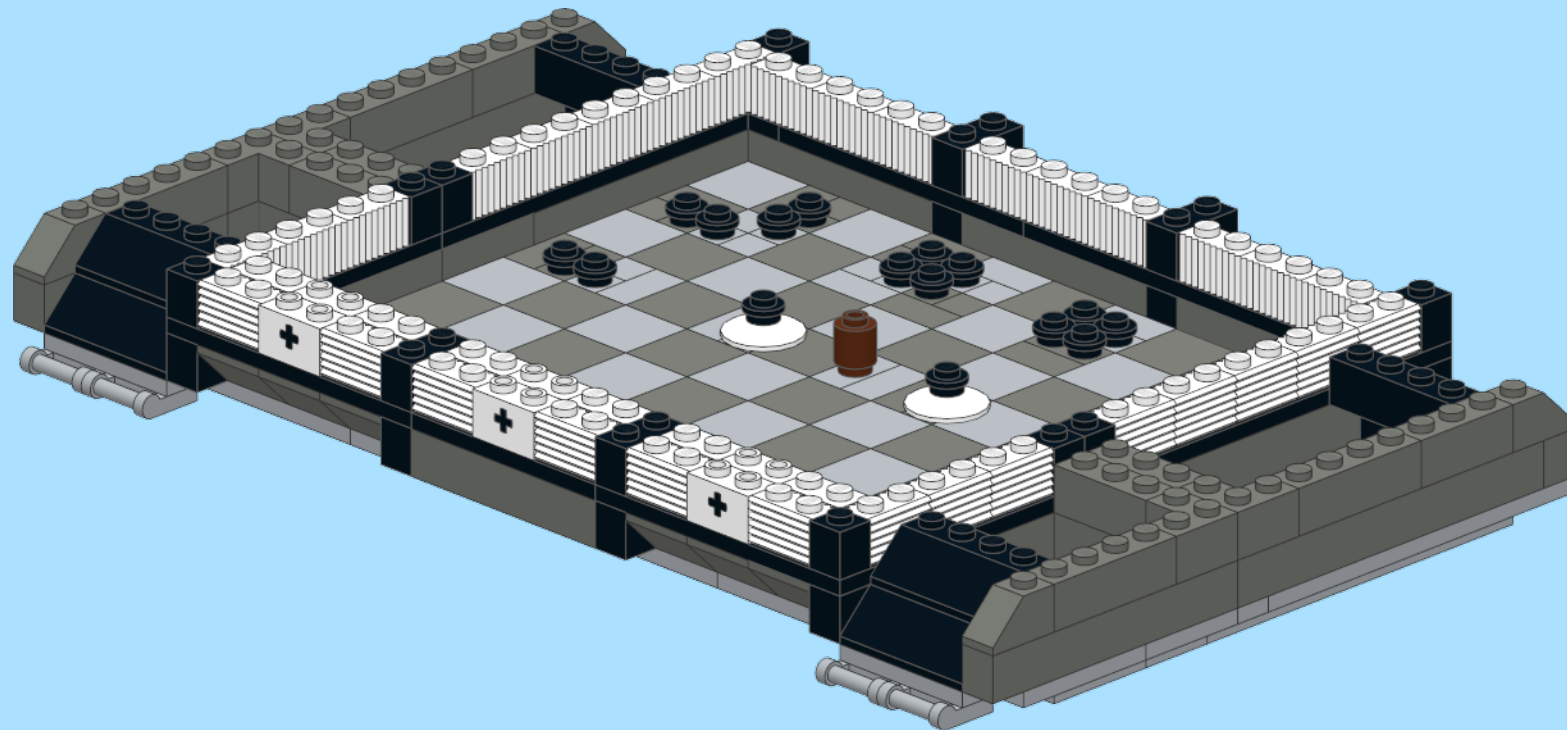
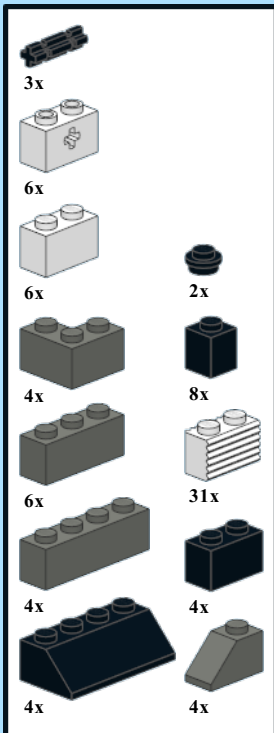

8

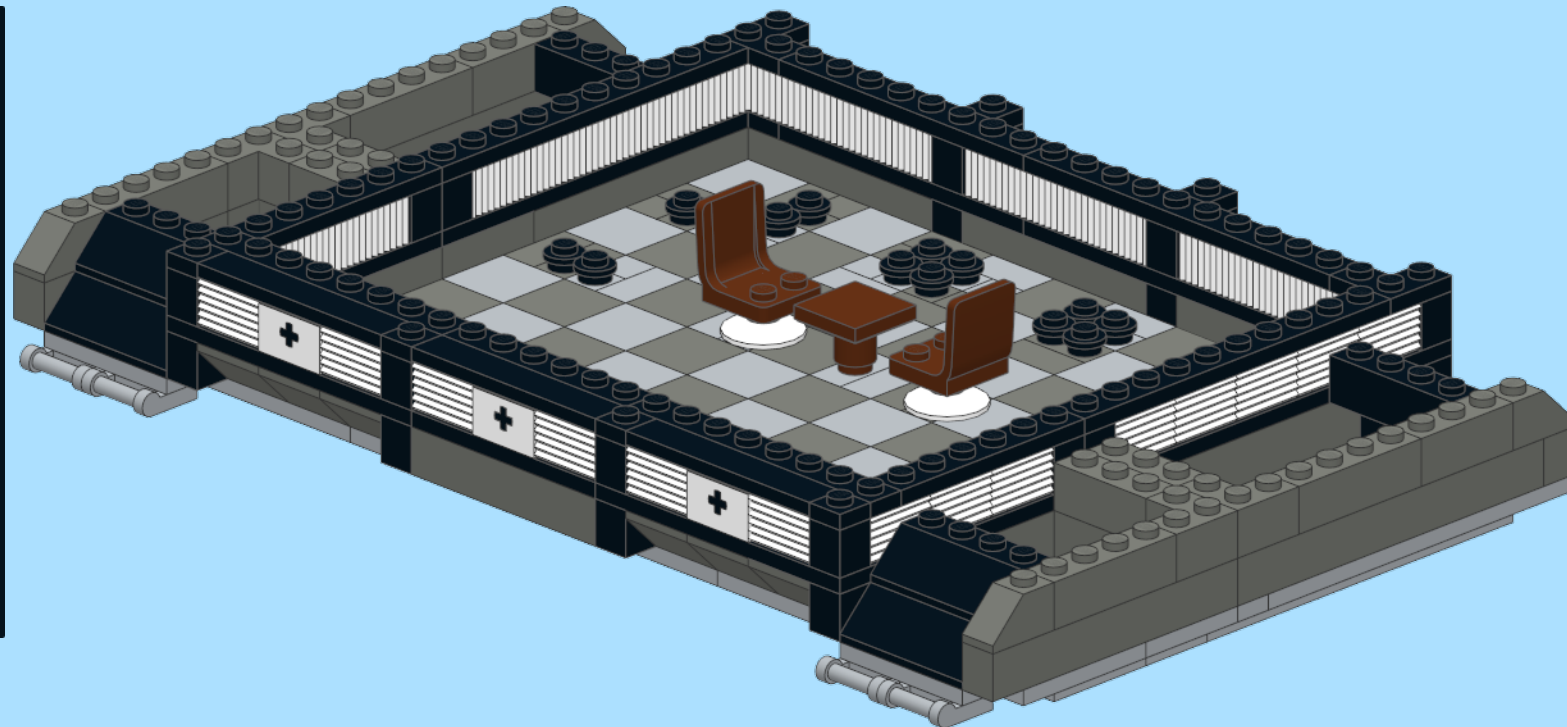
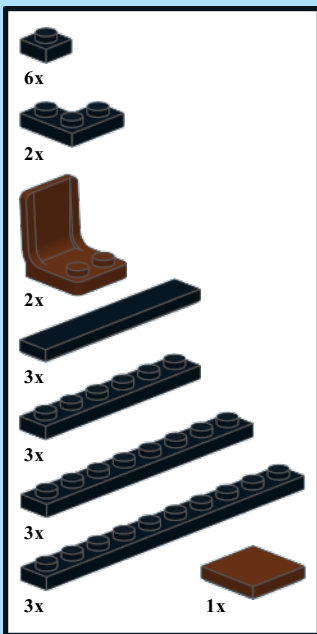

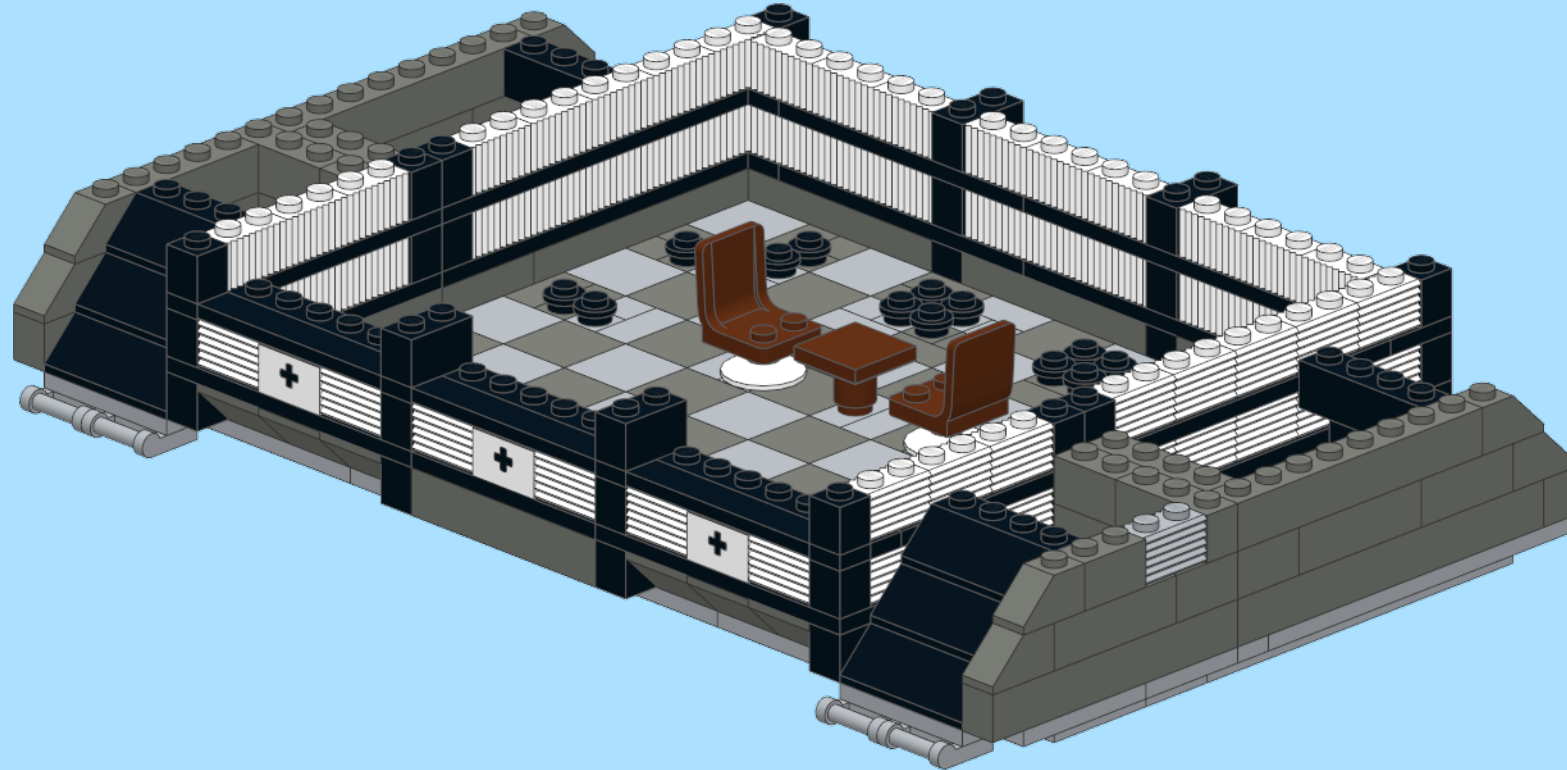
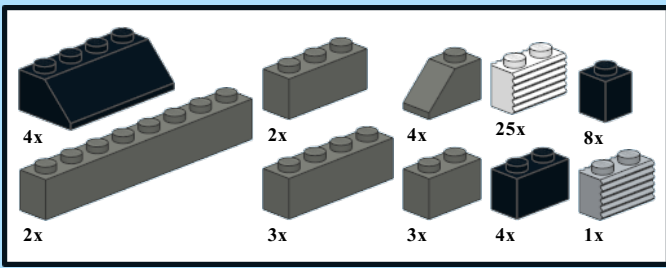

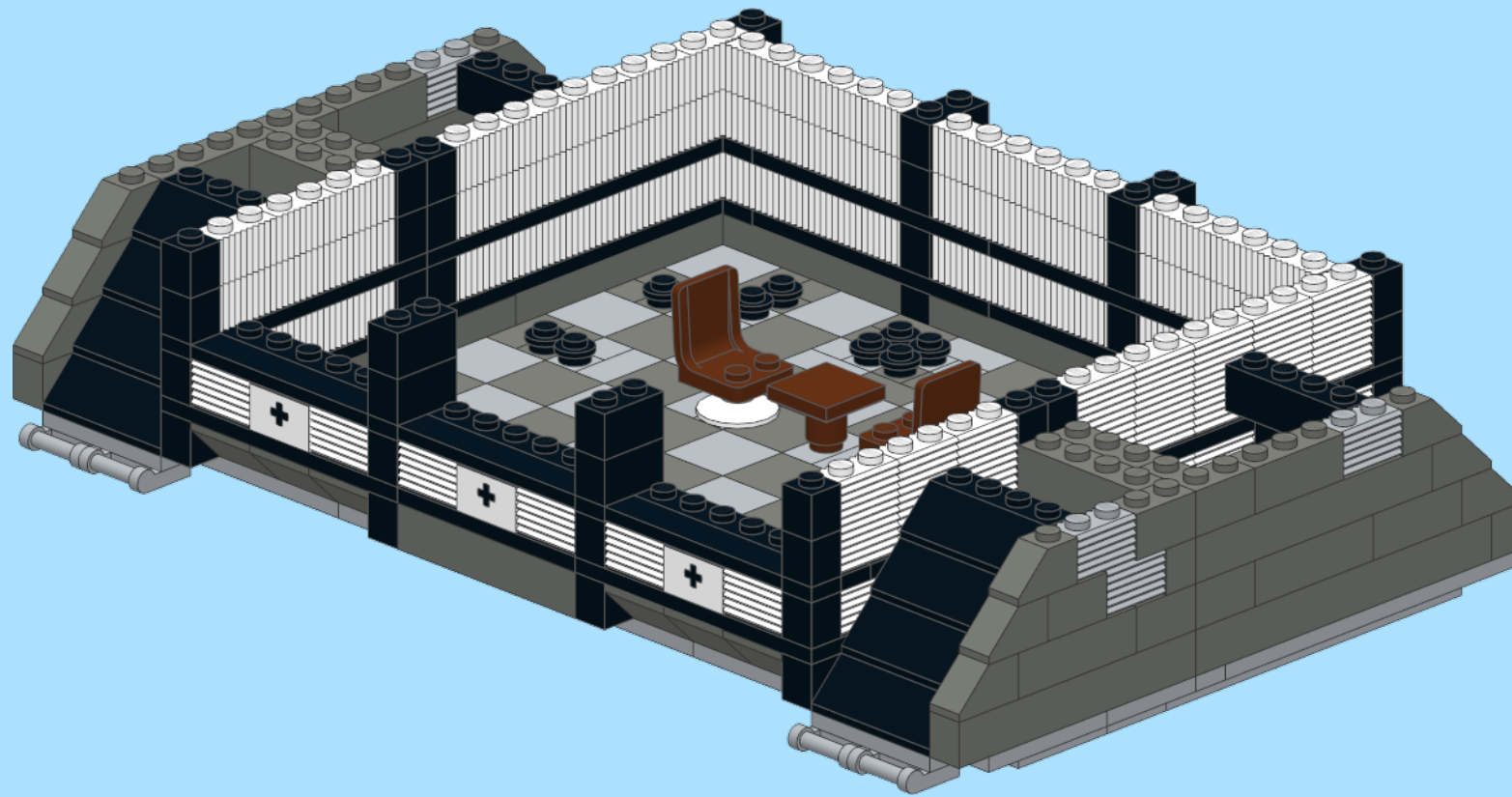
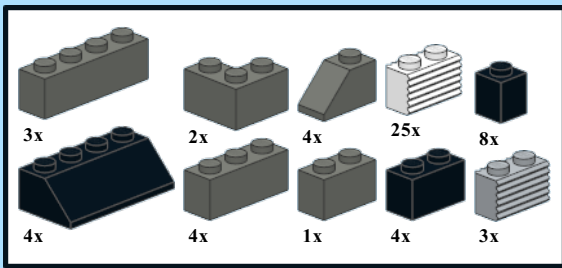

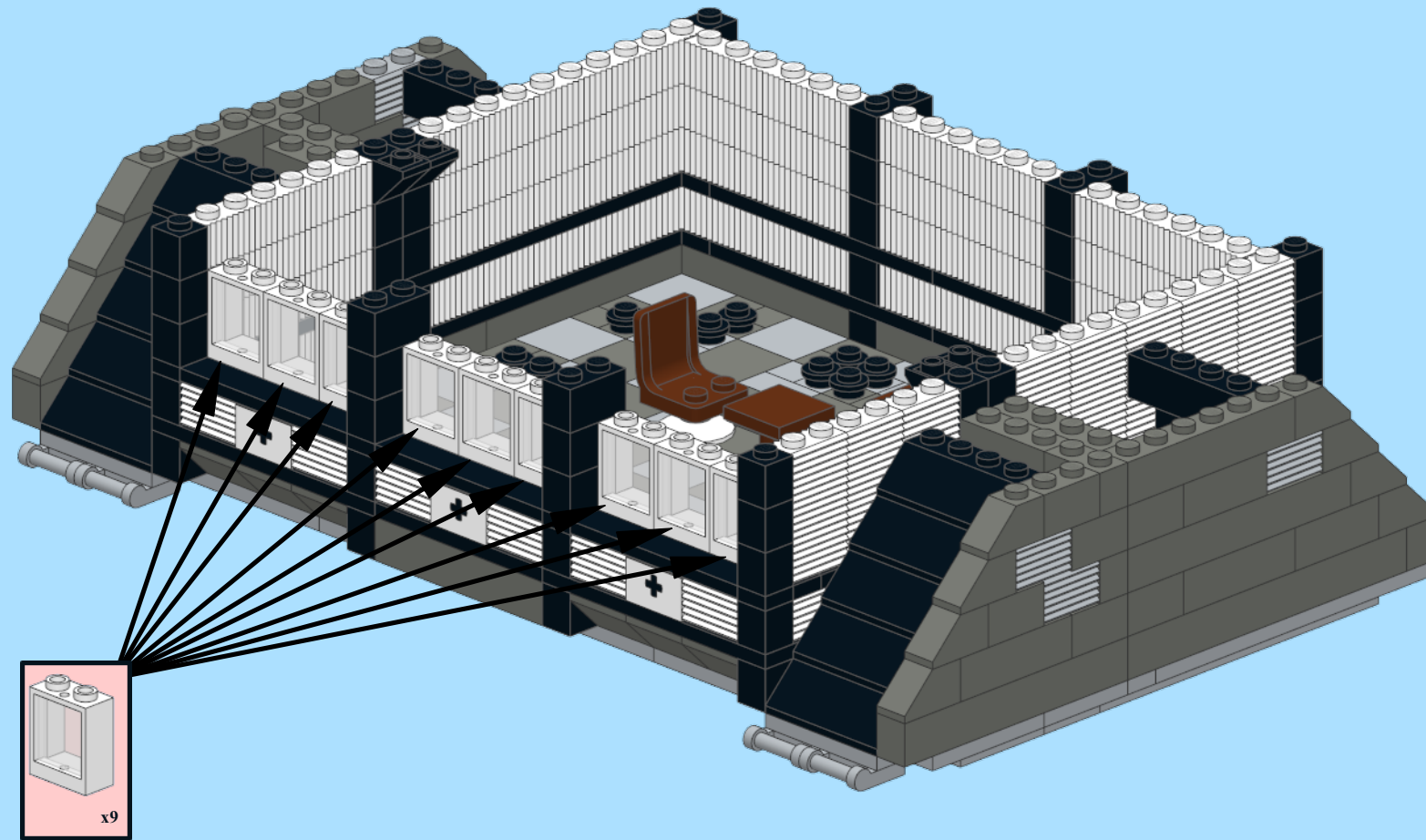
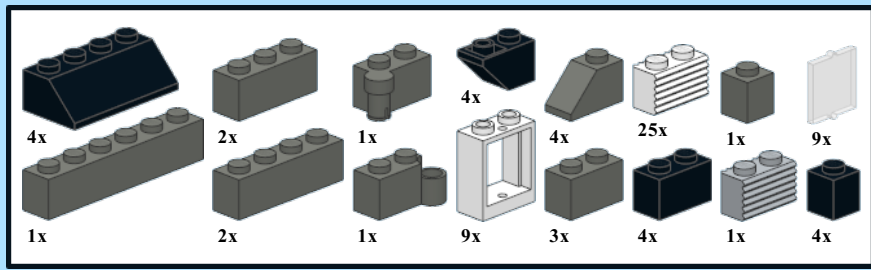

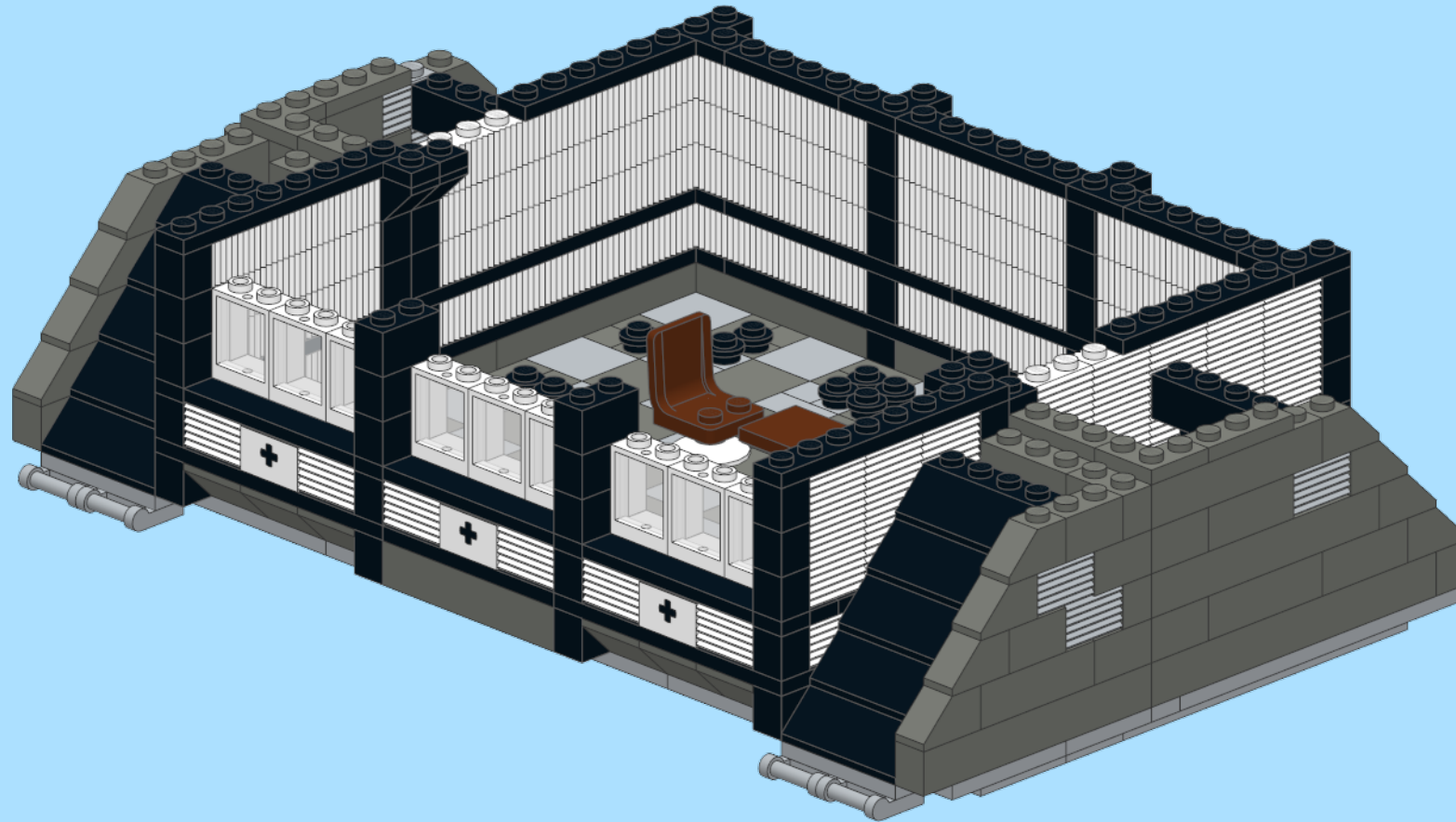
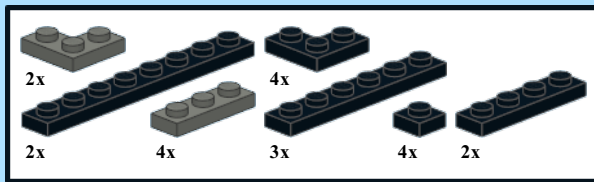

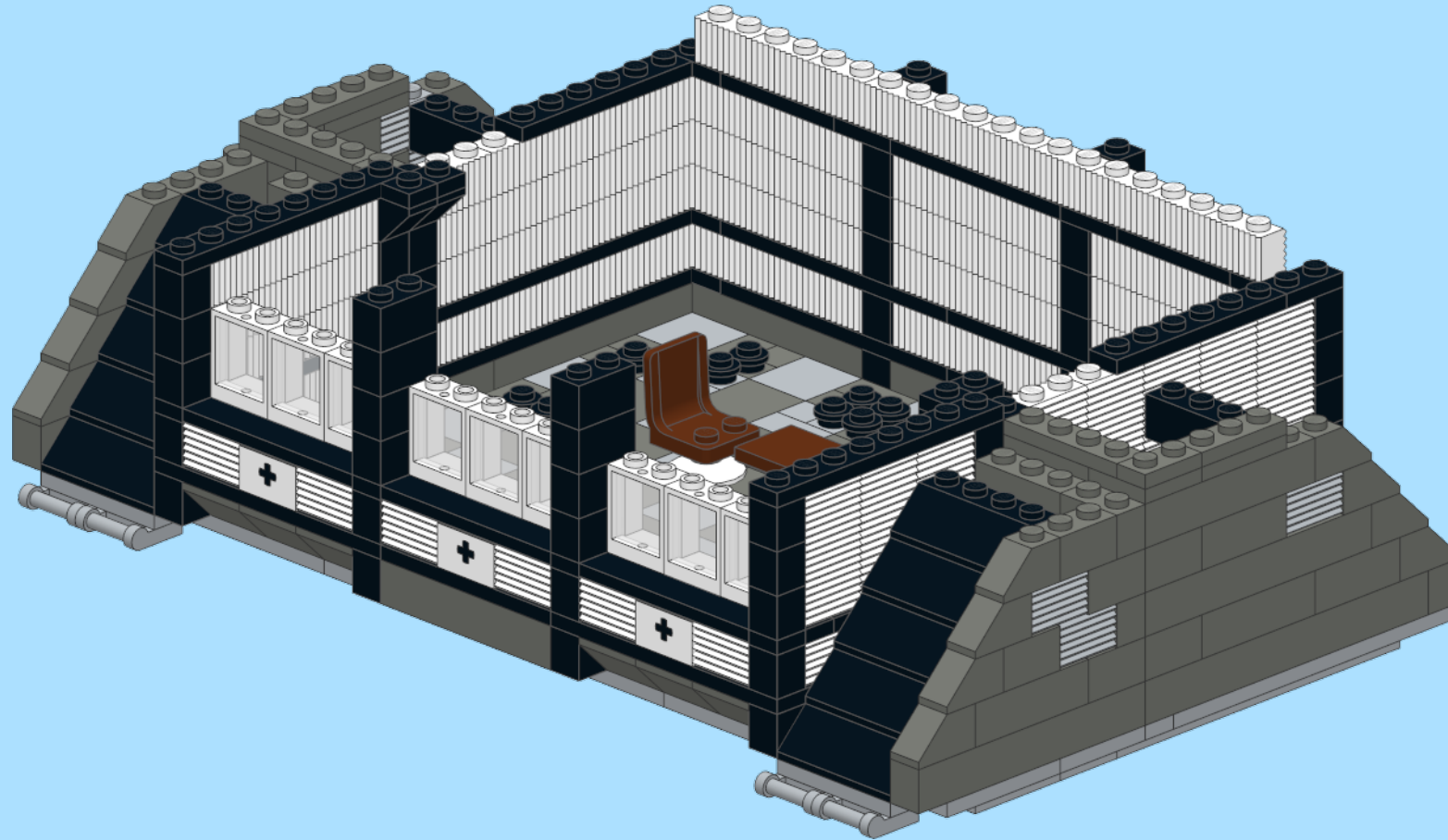
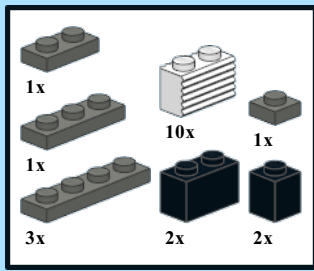

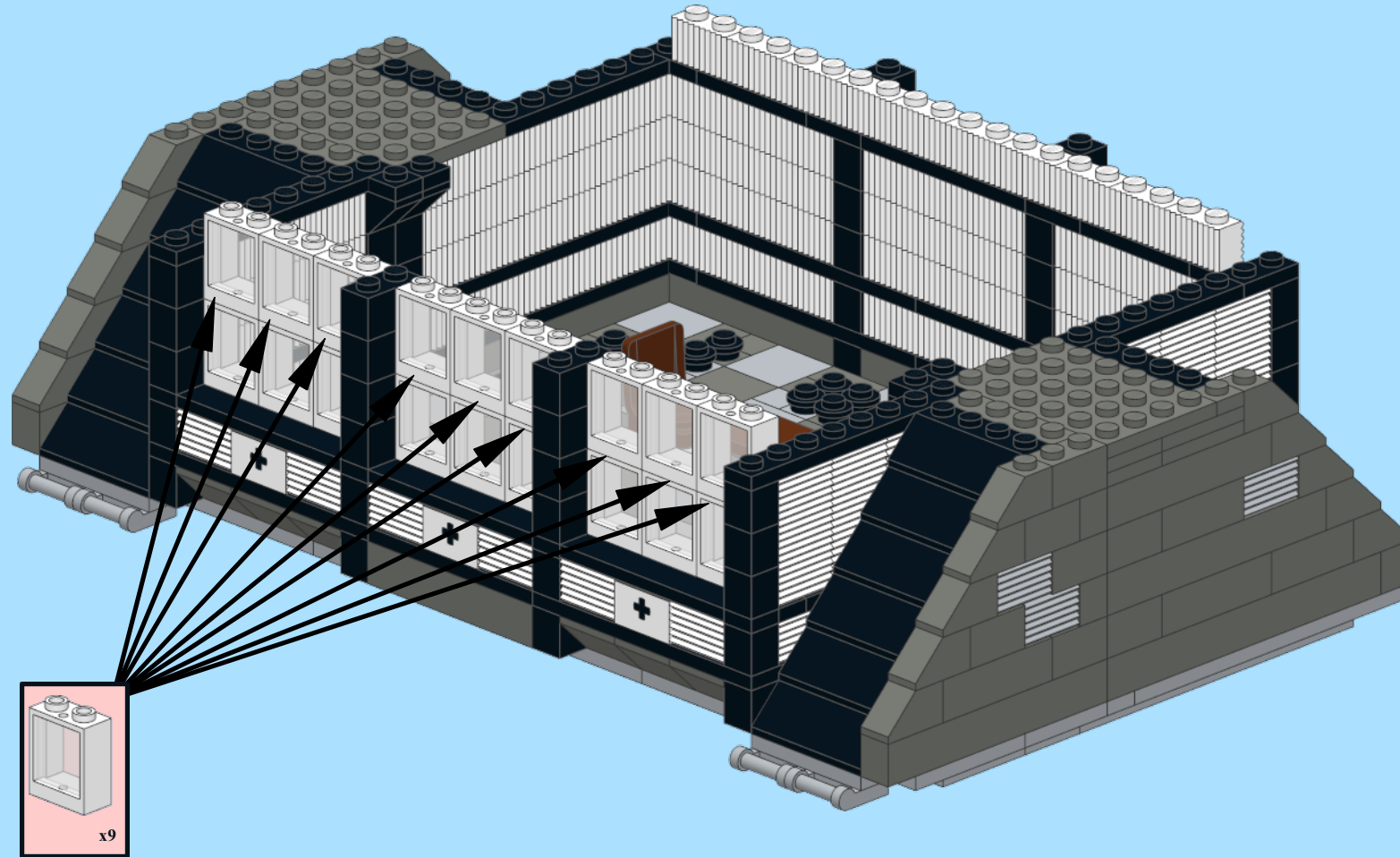
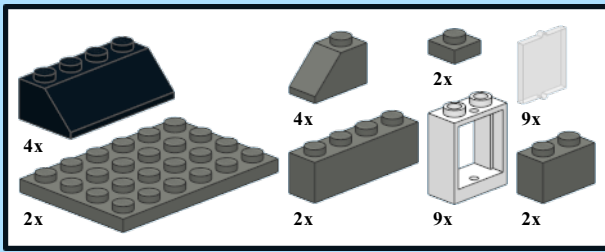

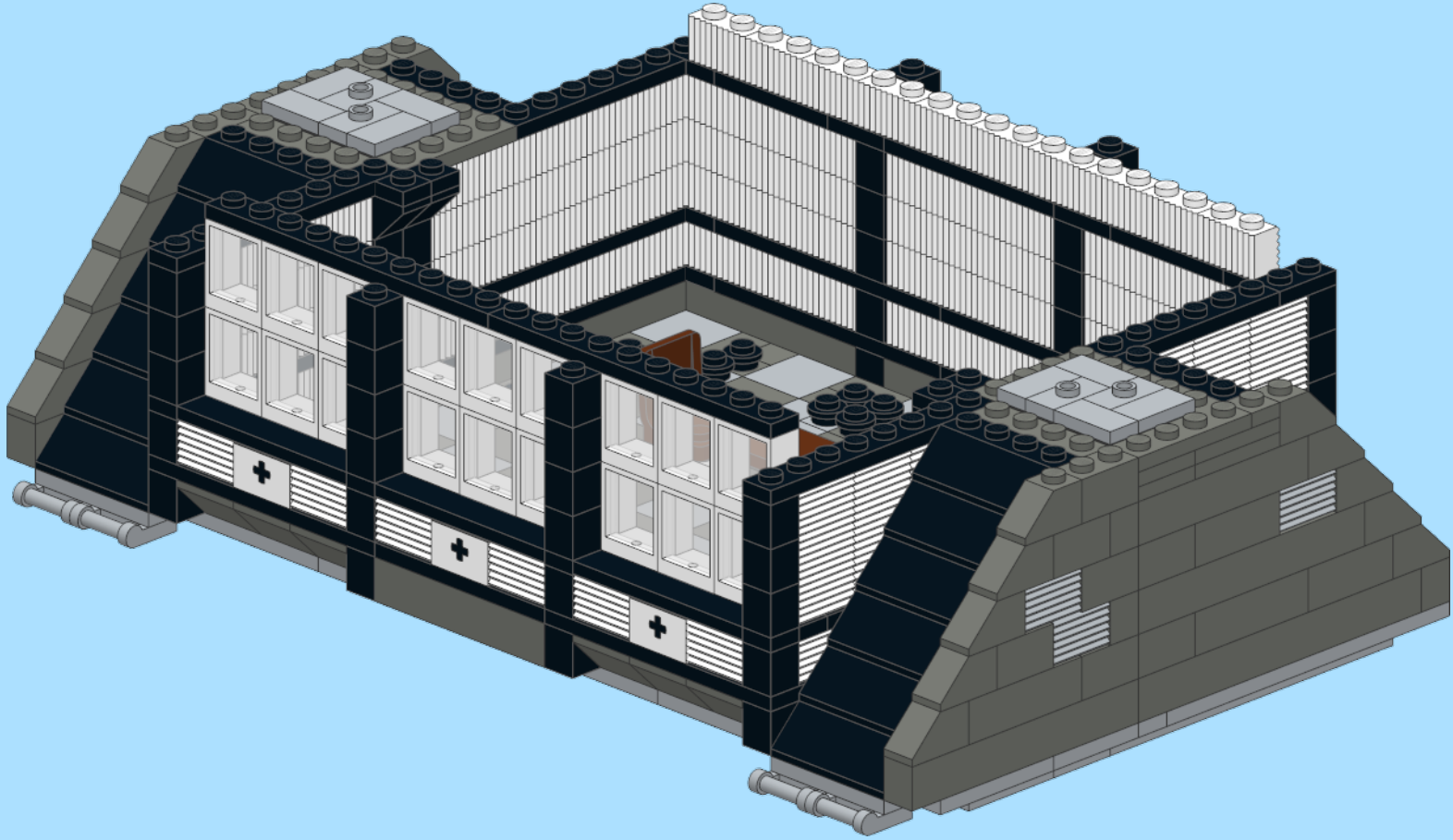
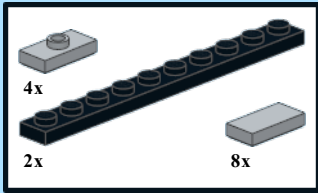

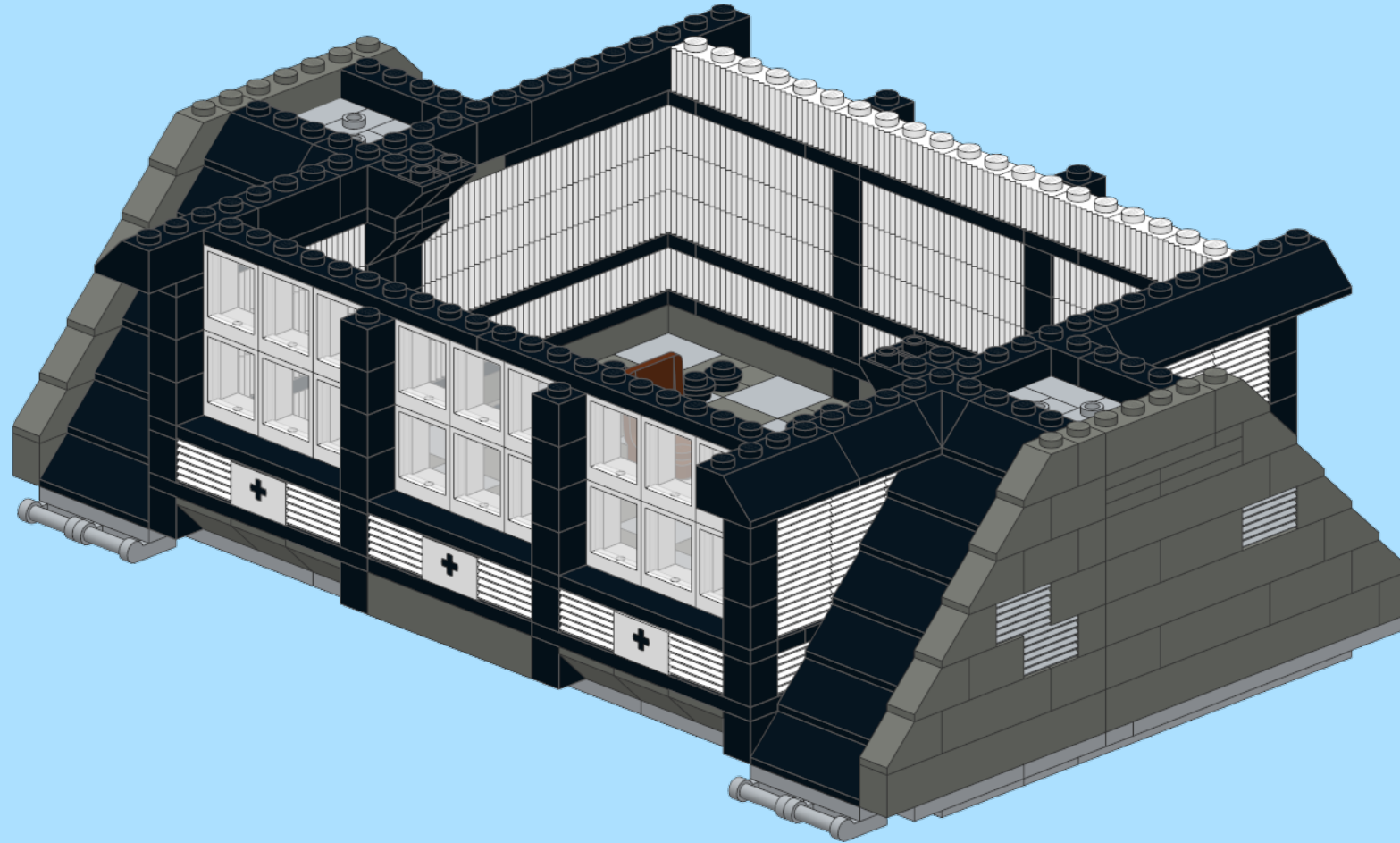
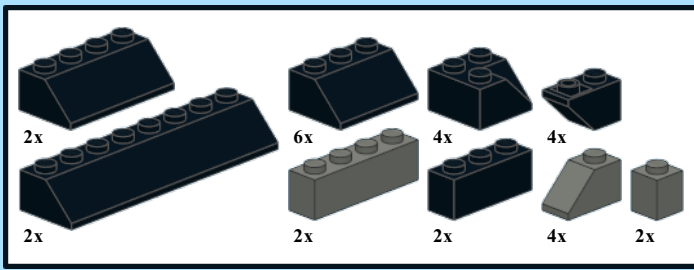

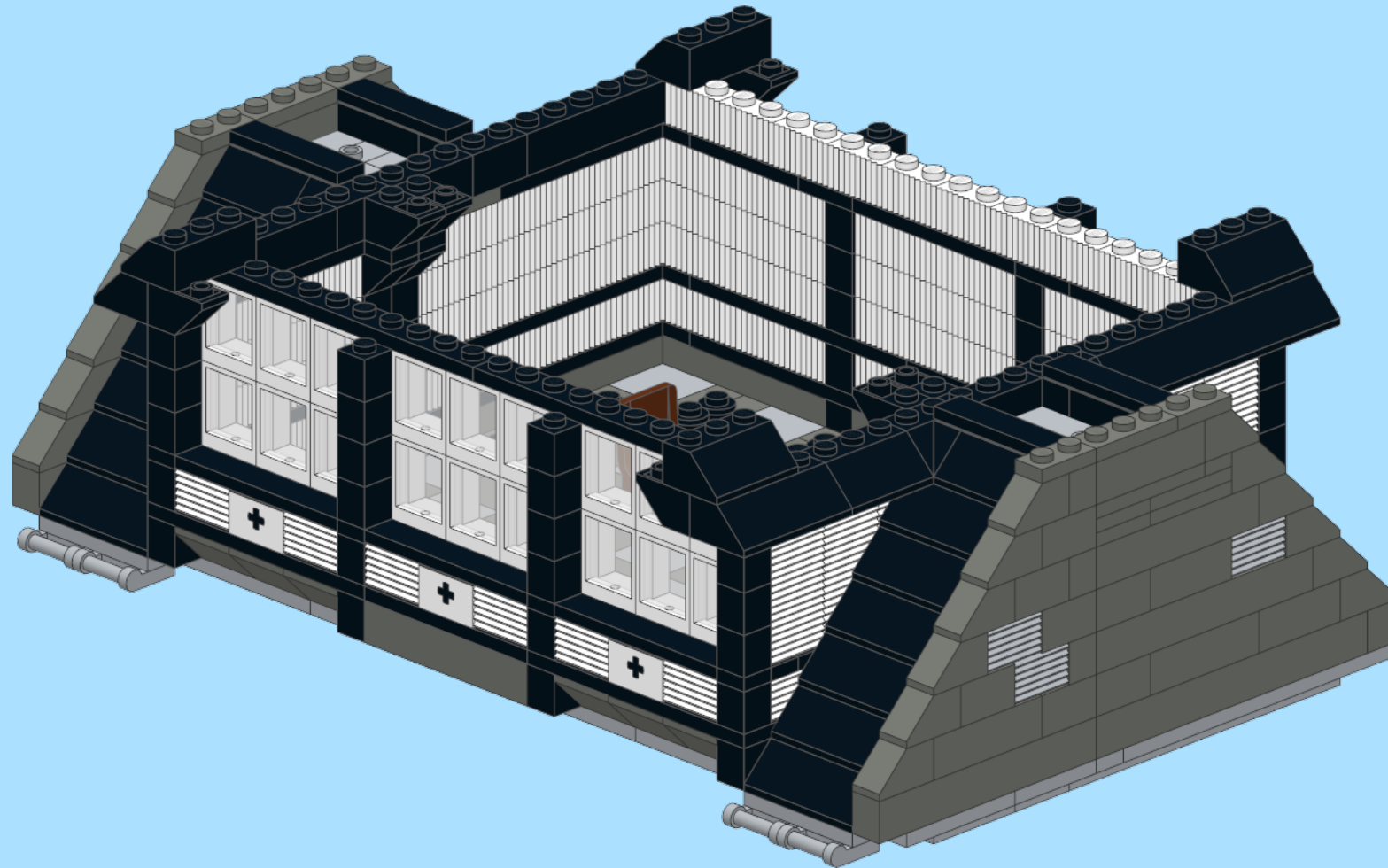
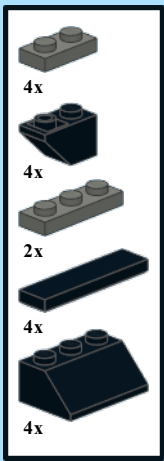

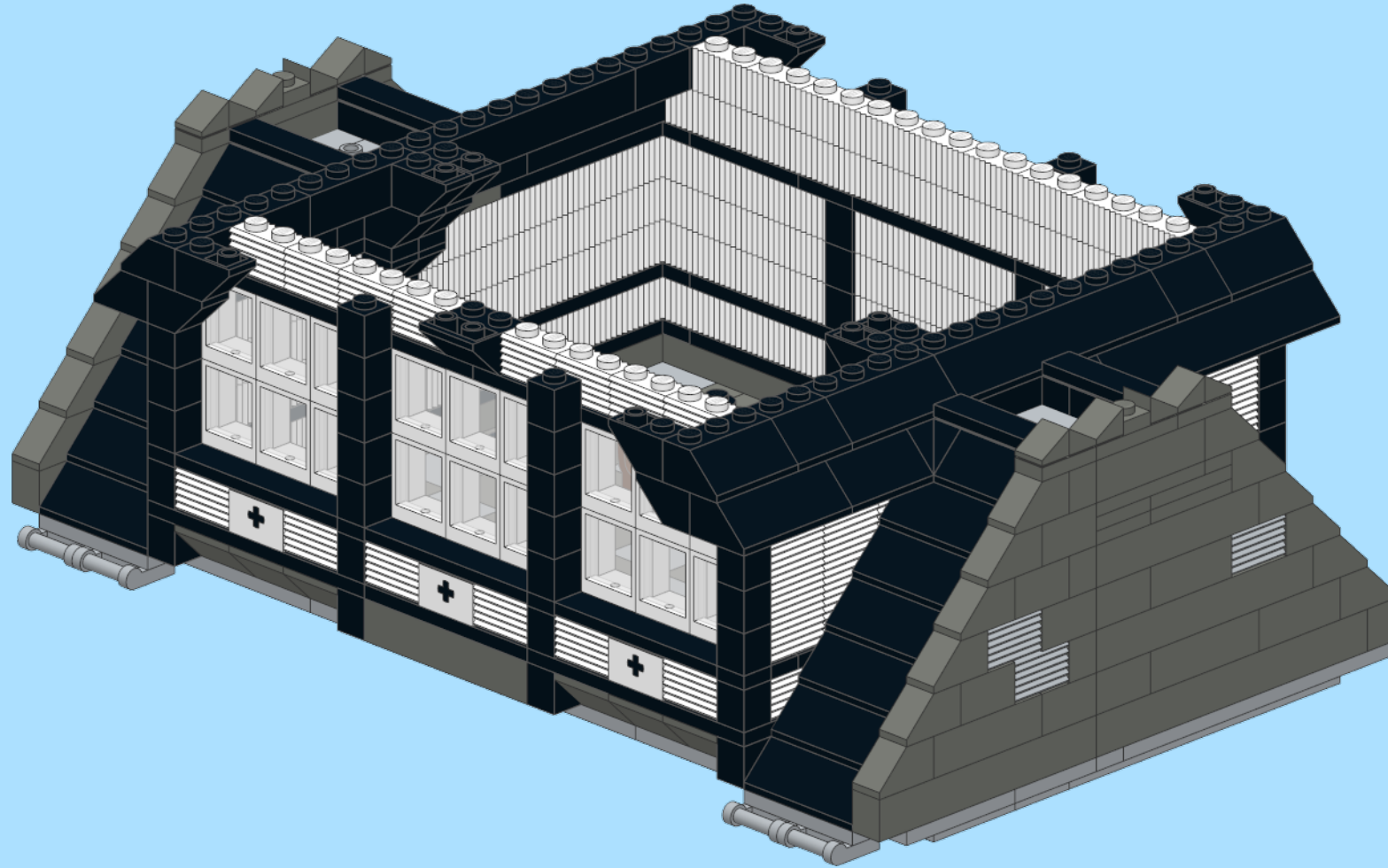
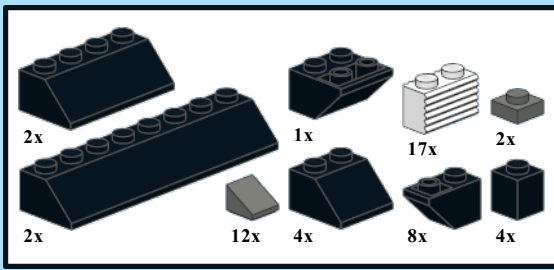

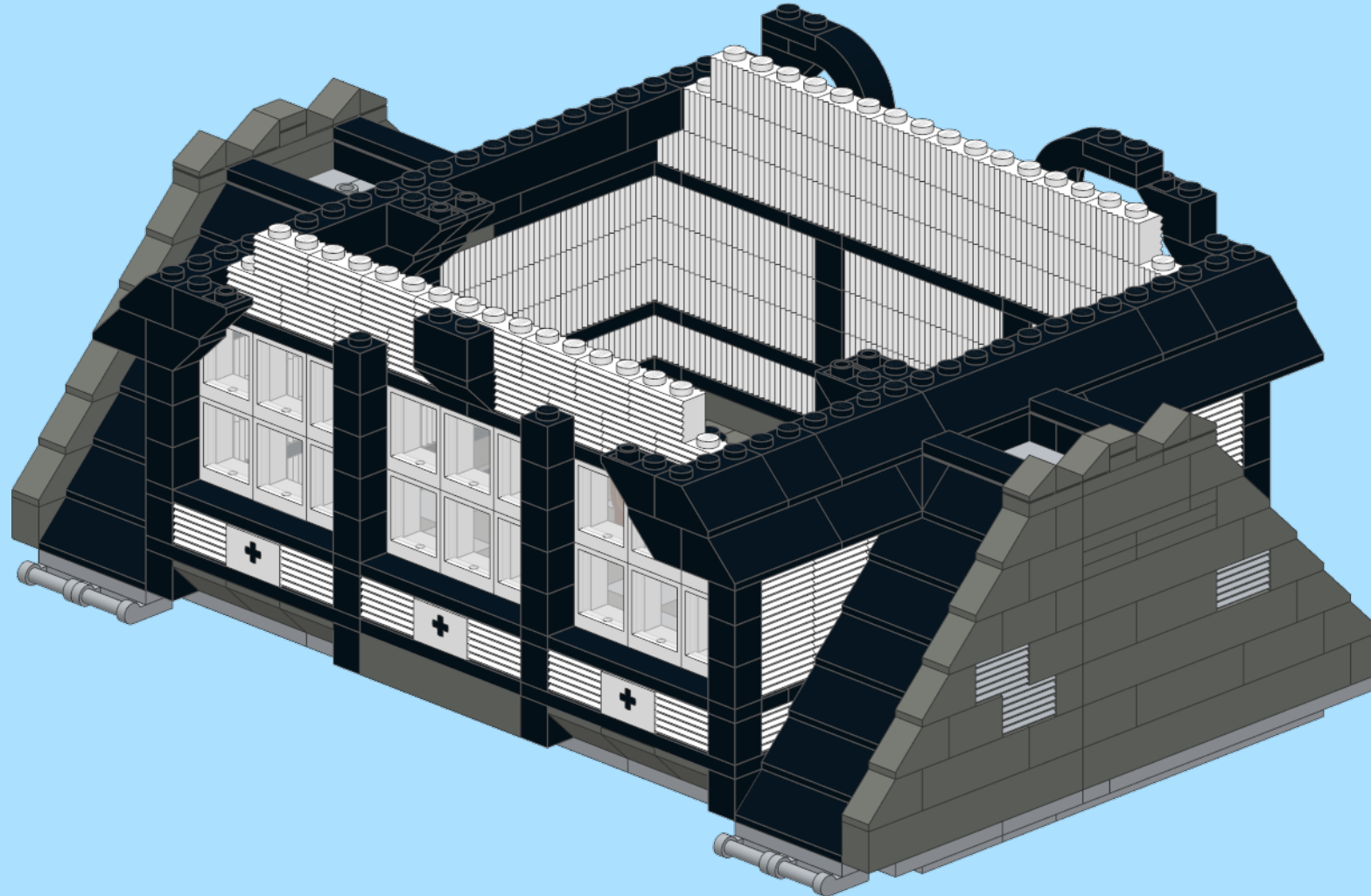
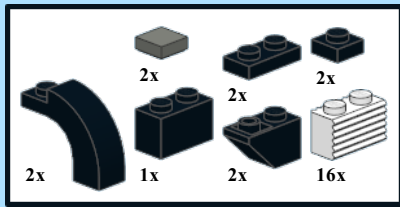

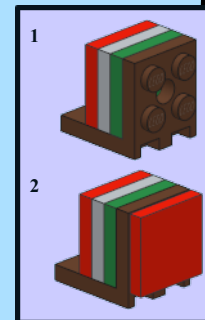
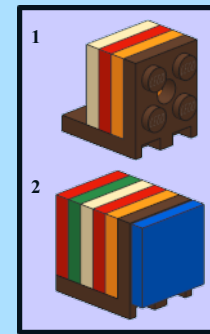
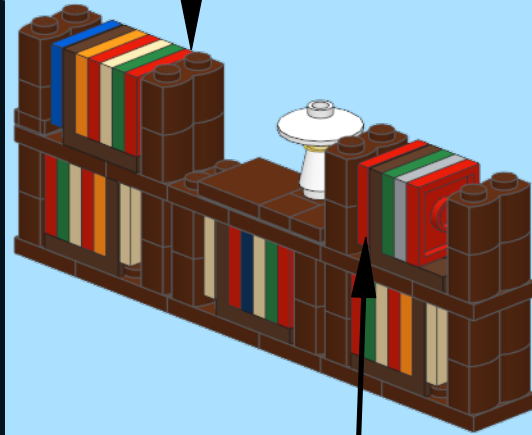
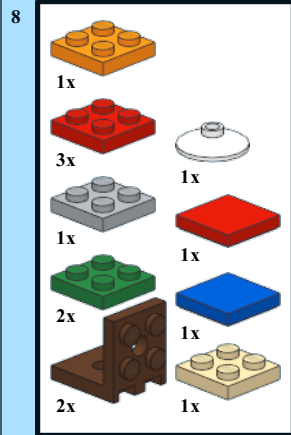
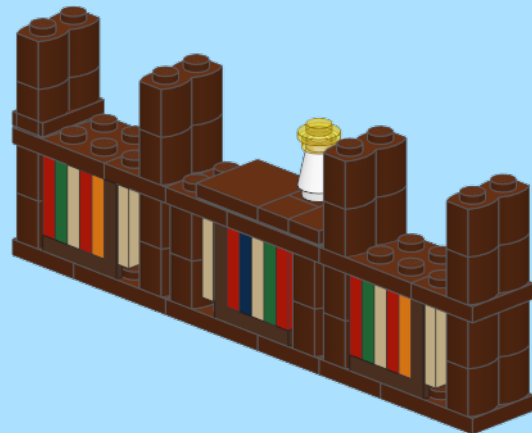
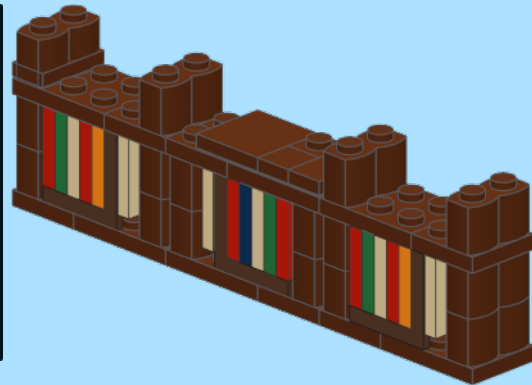
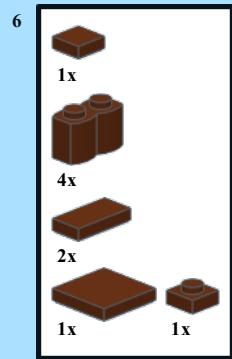
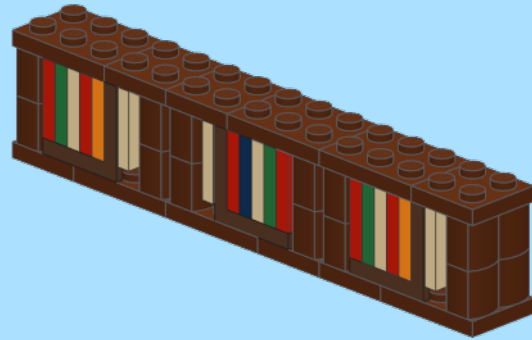
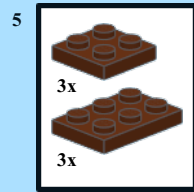

9

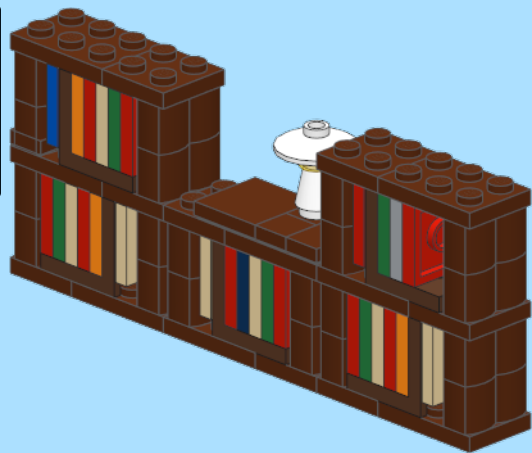
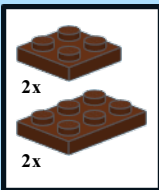

10

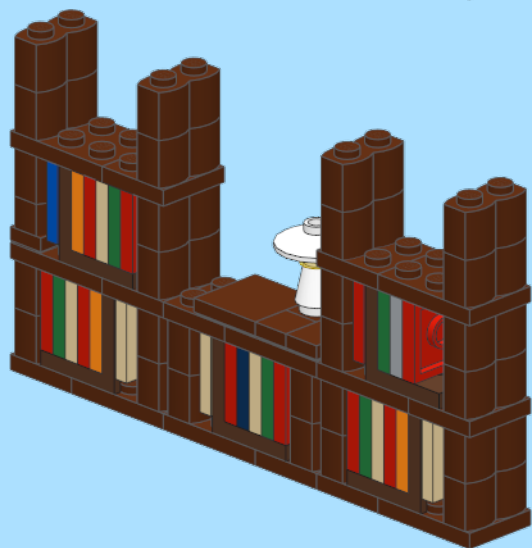

11

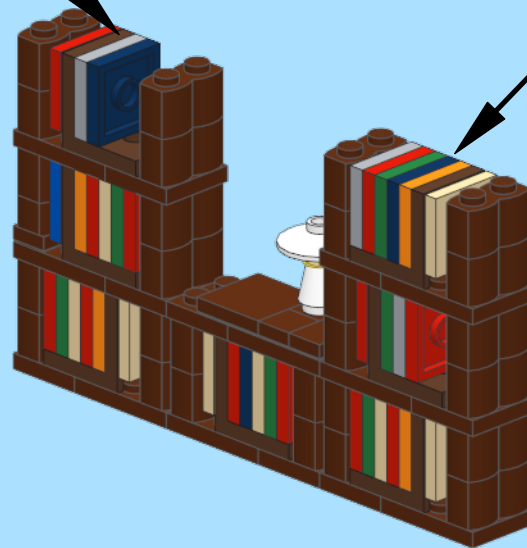
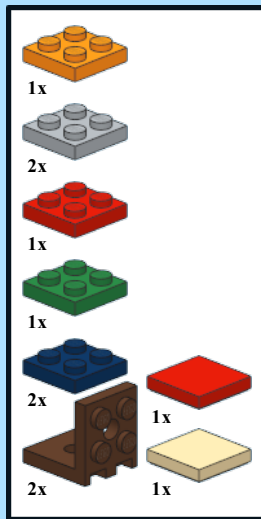

12

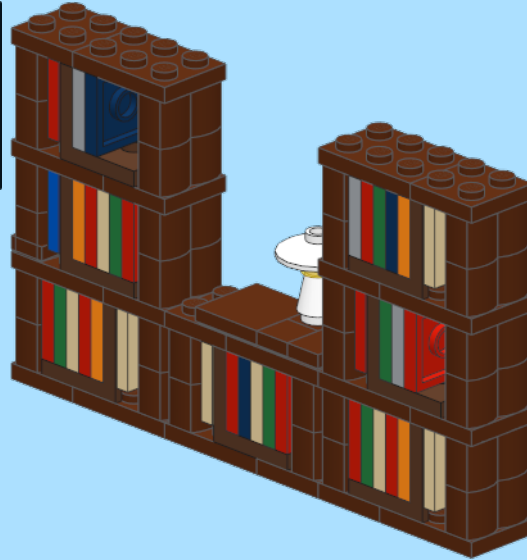
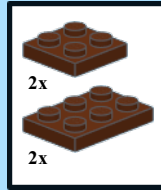

13

